



Quick Overview of Prices 2023/2024

- > Fireplaces
- > Urfeuer- open fireplace
- > Tiled stoves
- > Masonry heaters
- > KSO
- > BSO
- > BSK
- > BSG
- > Boiler
- > Iron Dog
- > Grilling and baking
- > MAS/MSS/GNF
- > USA/EOS/EAS

BRUNNER[®]

made in germany.

Price validity from 01.07.2023 to 30.06.2024.

All prices mentioned in this pricelist are in Euro.

Recommended retail prices excl. value-added tax.

This Quick Overview of Prices is an abstract of our main Pricelist 2023/2024.

It shows the most popular product combinations.

Of course, all products can be set up individually depending on your needs (refer to our main Pricelist 2023/2024).

This pricelist is not intended for the end customer.

Eventual typesetting errors or interim modifications of any kind are not considered to be reasons for a claim.

All contracts, deliveries and other services are subject to our "General terms and conditions of business".

Subject to technical changes; errors excepted.

Content

	Page
Fireplaces	5
Urfeuer- open fireplace	84
Tiled stoves	100
Masonry heaters	144
KSO	164
BSO	170
BSK	188
BSG	230
Boiler	244
Iron Dog	302
Grilling and baking	308
MAS, MSS, GNF	312
USA, EOS, EAS	356

Abbreviation - explication

DT	side-opening door
ST	lifting door
KT	tilting door
F	flat glass
R	round glass
DV	double glazing
EV	single glazing
Details for the corner fireplaces	
STR	lifting door right corner
STL	lifting door left corner
1T	one piece glass pane
2T	two-piece glass pane
Indications for inserts with additional door DHT	
DHTR	additional charging door, right side
DHTL	additional charging door, left side
DHTM	additional charging door, middle
Attention: the position of the DHT is always viewed from the glass pane side of the unit	
Indications for Tunnel inserts	
DT-DT	side opening door-side opening door (on both sides side opening)
DT-ST	side opening-lifting door (one side to open-one side to lift)
ST-KT	lifting-tilting door (one side to lift the other side to tilt)
ST-ST	lifting - lifting door (on both sides to lift)
Door hinge HKD 4.1/5.1/6.1 and front set B7/B8	
SSL	self closing left-hand stop
SSR	self closing right-hand stop
NSSL	non self closing left-hand stop
NSSR	not self-closing right-hand stop
GK	ceramic glass
GKB	ceramic glass coated
GKG	ceramic glass tinted
FR	chamotte inner lining
FR/Guss	Combustion chamber inner lining made of cast iron

Glazing formats series 5.0

Flat glazing

from page 12

flat

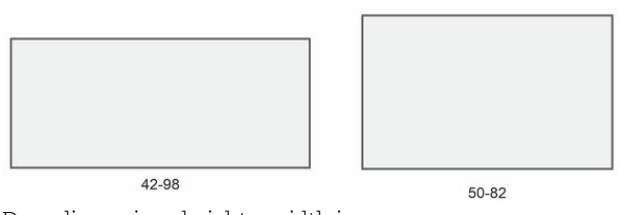
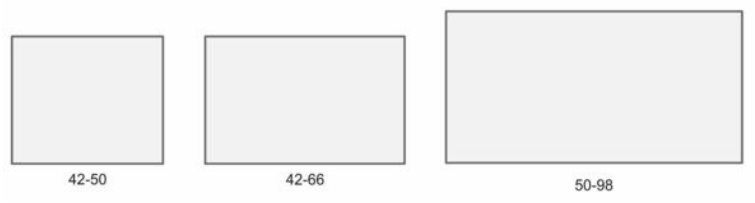

Door dimensions height x width in cm

Tunnel formats

from page 26

Tunnel

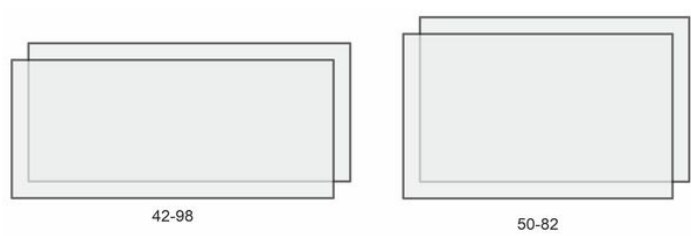
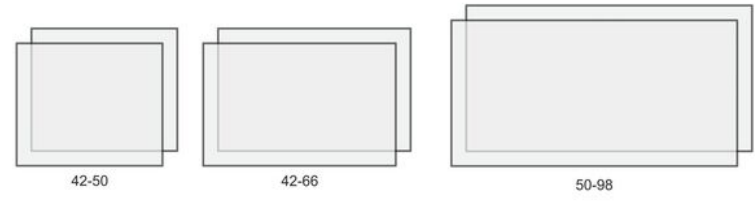

Door dimensions height x width in cm

Eck

Panorama

Eck corners

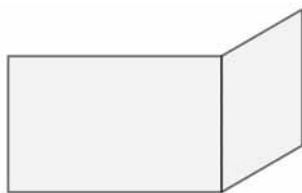
from
page
40

42-66-42

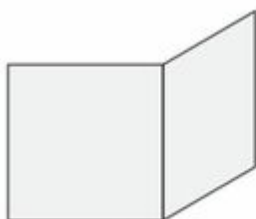

42-42-42



42-98-42



50-82-42

Door dimensions height x width x width in cm

Panorama formats

from
page
68

42-42-42-42

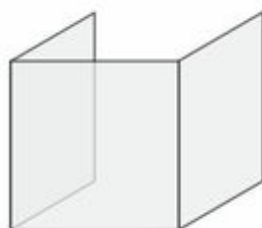

50-50-50-50

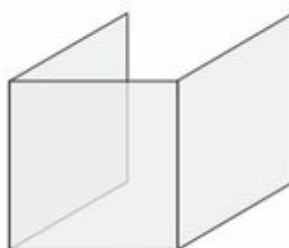

50-66-50-66

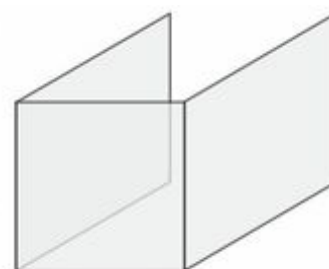

50-82-50-82

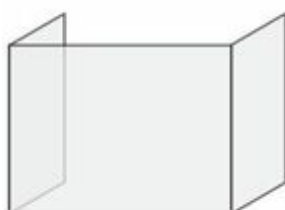

50-34-66-34



50-34-98-34

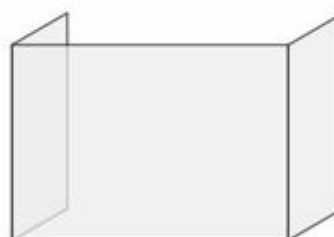

58-34-82-34

Door dimensions height x side width x front width x side width in cm

Door frame - mounting frame series 5.0

lifting door

with mounting frame

with door frame

side-opening door

with mounting bracket

with door frame



Smoke hood variants series 5.0



Cast iron dome



Cast iron dome with heat exchanger rings



Cast iron dome low



Modular Accumulator MAS

Equipment EAS series 5.0

Preassembled EAS components, door switch, thermocouple, air connection box D=125 with motor transmission

Glazing formats Series 4.1

Flat glazing

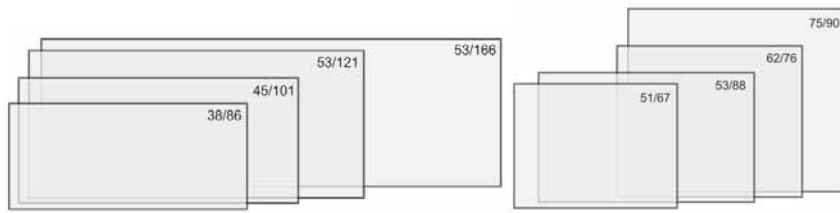

Architektur-Kamin

Stil-Kamin

Door dimensions height x width in cm

from
page
12

Tunnel formats

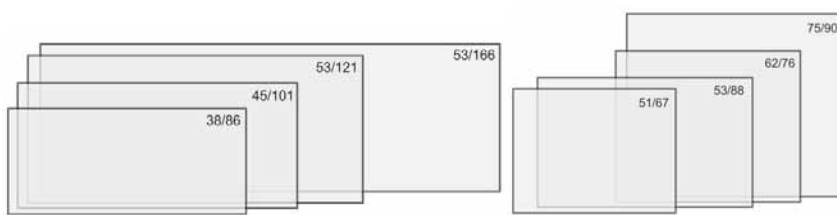

Architektur-Kamin

Stil-Kamin

Door dimensions height x width in cm

from
page
26

Eck corners

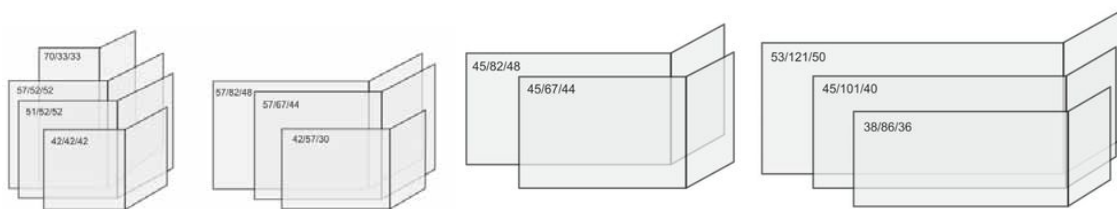

Eck-Kamin

Architektur-Eck- fireplace

Door dimensions height x width x width in cm

from
page
40

Panorama formats

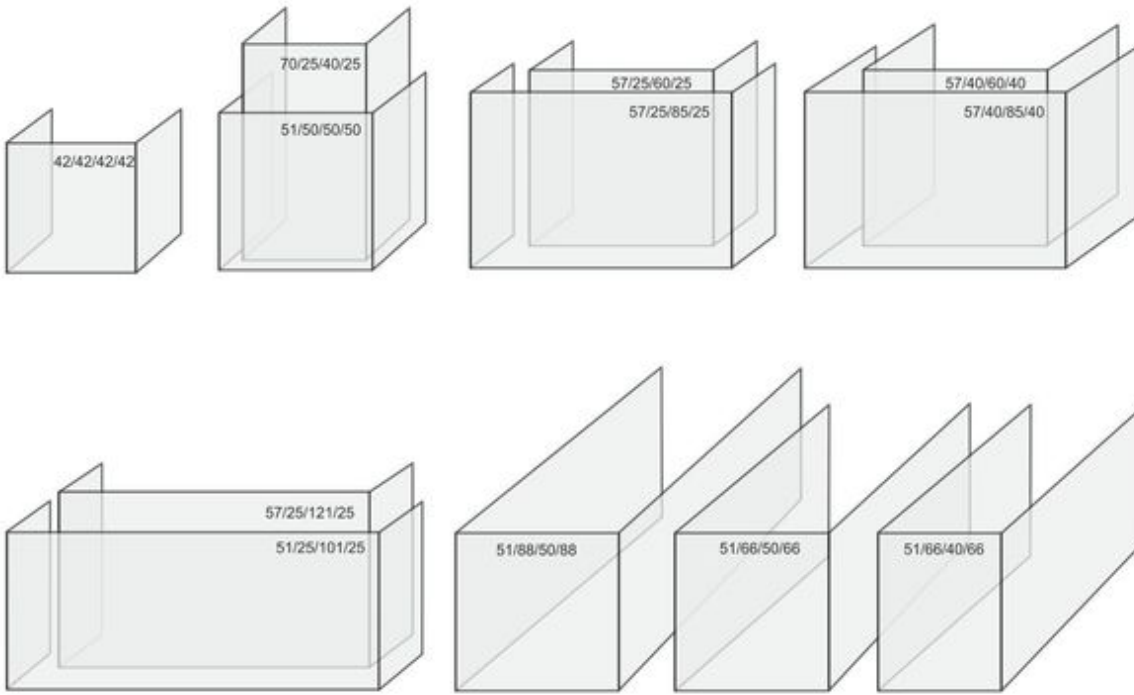

Door dimensions height x side width x front width x side width in cm

Door frame - mounting frame Series 4.1

flat



Door frame



Mounting frame 50 mm



Mounting frame 70 mm

Tunnel

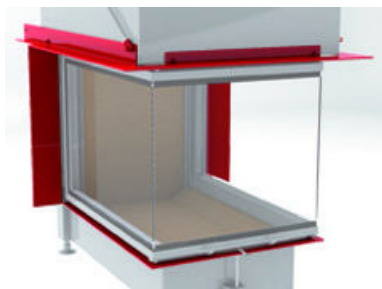

Panorama narrow frame



Panorama wide frame (Fire table)

Eck

Panorama

Smoke hood variants Series 4.1



Cast iron hot air hood ø 200 mm



Cast iron dome



Modular Accumulator MAS

Supplementary equipment

- EAS** Combustion controls with potential-free relay (without additional functions) consisting of display, 1 x flush-mount box, door switch, thermocouple & bus line, each 2 m long. Preassembled EAS/EOS components, door switch, thermocouple, motor box with transmission and ø 125 mm air flap, flexible hose with adjustable clamps
- EOS** Combustion control with graphic touchscreen display and additional functions (differential temperature control, Moritz's flap control) consisting of: Display with control unit, 2 x flush-mount box, door switch, thermocouple, bus and connecting line, each 2 m long, 4 x water sensors with immersion sleeve and 2x extension cable 3 m. Preassembled EOS components: door switch, thermocouple, motor box with transmission and ø 125 mm air flap, flexible hose with adjustable clamps



BKH 5.0 flat 42-50 DT

Set consists of:	Art. No.	No.	Price
BKH 5.0 flat 42-50 DT GK FR,		1	
Mounting bracket / door frame		1	
Chamotte inner lining (FR)		1	



Additional options (for all smoke hood variants)			
EAS (see page7)			1561,50
Reduced price for EAS without display			-148,00
ceramic glass coated (GKB)			94,50
Cast iron inner lining (FR/Guss)			412,00
Catalyst module BKH 5.0	HK000210		871,00
Supply air connection box ø 125 mm included at EAS version	HK000135		170,50
Supply air connection box ø 150 mm	HK000136		188,50
Heat protection panel, rear	HK004450		150,00
Heat protection panel, rear with one side wall	HK004450-01		245,50
Heat protection panel, rear with two side walls	HK004450-02		354,00

Smoke hood variants:



+ Cast iron dome ø 200 mm	10087	1	
Front variants:			
Mounting bracket		SET213148	3137,00
Door frame, black		SET213149	3277,00
Additional option for cast iron dome			
Cast iron dome ø 180 mm	D004186		0,00



+ Cast iron dome ø 200 mm and cast iron heat exchanger rings	R015006-02	1	
Front variants:			
Mounting bracket		SET213150	3608,00
Door frame, black		SET213151	3748,00



+ Cast iron dome ø 180 mm low	D016042	1	
Front variants:			
Mounting bracket		SET213152	3388,00
Door frame, black		SET213153	3528,00



+ Modular accumulator MAS 440 double-layered	R009042	5	
Cast iron cover MAS ø 180	R009095-01	1	
Mounting ring	10077	1	
Front variants:			
Mounting bracket		SET213154	4530,50
Door frame, black		SET213155	4670,50
Additional option MAS			
Exchange connecting piece ø 200 mm	R009105		58,00
Exchange connecting piece ø 160 mm	07137		58,00

Energy efficiency index A +

BKH 5.0 flat 42-50 ST



Set consists of:	Art. No.	No.	Price
BKH 5.0 flat 42-50 ST GK FR,		1	
Mounting frame 60 mm / door frame		1	
Chamotte inner lining (FR)		1	

Additional options (for all smoke hood variants)			
EAS (see page 7)			1561,50
Reduced price for EAS without display			-148,00
ceramic glass coated (GKB)			94,50
Cast iron inner lining (FR/Guss)			412,00
Catalyst module BKH 5.0	HK000210		871,00
Supply air connection box ø 125 mm included at EAS version	HK000135		170,50
Supply air connection box ø 150 mm	HK000136		188,50
Heat protection panel, rear	HK004450		150,00
Heat protection panel, rear with one side wall	HK004450-01		245,50
Heat protection panel, rear with two side walls	HK004450-02		354,00

Smoke hood variants:



+ Cast iron dome ø 200 mm		10087	1	
Front variants:				
Door frame, black		SET213156		4905,00
Mounting frame, black 60 mm		SET213157		4926,50
Additional option for cast iron dome				
Cast iron dome ø 180 mm		D004186		0,00



+ Cast iron dome ø 200 mm and cast iron heat exchanger rings		R015006-02	1	
Front variants:				
Door frame, black		SET213158		5376,00
Mounting frame, black 60 mm		SET213159		5397,50



+ Cast iron dome ø 180 mm low		D016042	1	
Front variants:				
Door frame, black		SET213160		5156,00
Mounting frame, black 60 mm		SET213161		5177,50



+ Modular accumulator MAS 440 double-layered		R009042	5	
Cast iron cover MAS ø 180		R009095-01	1	
Mounting ring		10077	1	
Front variants:				
Door frame, black		SET213162		6298,50
Mounting frame, black 60 mm		SET213163		6320,00
Additional option MAS				
Exchange connecting piece ø 200 mm		R009105		58,00
Exchange connecting piece ø 160 mm		07137		58,00

Energy efficiency index A +



BKH 5.0 flat 42-66 DT

Set consists of:	Art. No.	No.	Price
BKH 5.0 flat 42-66 DT GK FR,		1	
Mounting bracket / door frame		1	
Chamotte inner lining (FR)		1	

Additional options (for all smoke hood variants)			
EAS (see page7)			1561,50
Reduced price for EAS without display			-148,00
ceramic glass coated (GKB)			106,00
Cast iron inner lining (FR/Guss)			441,50
Catalyst module BKH 5.0	HK000210		871,00
Supply air connection box ø 125 mm included at EAS version	HK000135		170,50
Supply air connection box ø 150 mm	HK000136		188,50
Heat protection panel, rear	HK004450		150,00
Heat protection panel, rear with one side wall	HK004450-01		245,50
Heat protection panel, rear with two side walls	HK004450-02		354,00

Smoke hood variants:



+ Cast iron dome ø 200 mm	10087	1	
Front variants:			
Mounting bracket		SET213164	3337,00
Door frame, black		SET213165	3484,00
Additional option for cast iron dome			
Cast iron dome ø 180 mm	D004186		0,00



+ Cast iron dome ø 200 mm and cast iron heat exchanger rings	R015006-02	1	
Front variants:			
Mounting bracket		SET213166	3808,00
Door frame, black		SET213167	3955,00



+ Cast iron dome ø 180 mm low	D016042	1	
Front variants:			
Mounting bracket		SET213168	3588,00
Door frame, black		SET213169	3735,00



+ Modular accumulator MAS 440 double-layered	R009042	5	
Cast iron cover MAS ø 180	R009095-01	1	
Mounting ring	10077	1	
Front variants:			
Mounting bracket		SET213170	4730,50
Door frame, black		SET213171	4877,50
Additional option MAS			
Exchange connecting piece ø 200 mm	R009105		58,00
Exchange connecting piece ø 160 mm	07137		58,00

Energy efficiency index A +

BKH 5.0 flat 42-66 ST



Set consists of:	Art. No.	No.	Price
BKH 5.0 flat 42-66 ST GK FR,		1	
Mounting frame 60 mm / door frame		1	
Chamotte inner lining (FR)		1	

Additional options (for all smoke hood variants)			
EAS (see page 7)			1561,50
Reduced price for EAS without display			-148,00
ceramic glass coated (GKB)			106,00
Cast iron inner lining (FR/Guss)			441,50
Catalyst module BKH 5.0	HK000210		871,00
Supply air connection box ø 125 mm included at EAS version	HK000135		170,50
Supply air connection box ø 150 mm	HK000136		188,50
Heat protection panel, rear	HK004450		150,00
Heat protection panel, rear with one side wall	HK004450-01		245,50
Heat protection panel, rear with two side walls	HK004450-02		354,00

Smoke hood variants:



+ Cast iron dome ø 200 mm	10087	1	
Front variants:			
Door frame, black		SET213172	5114,50
Mounting frame, black 60 mm		SET213173	5132,00
Additional option for cast iron dome			
Cast iron dome ø 180 mm	D004186		0,00



+ Cast iron dome ø 200 mm and cast iron heat exchanger rings	R015006-02	1	
Front variants:			
Door frame, black		SET213174	5585,50
Mounting frame, black 60 mm		SET213175	5603,00



+ Cast iron dome ø 180 mm low	D016042	1	
Front variants:			
Door frame, black		SET213176	5365,50
Mounting frame, black 60 mm		SET213177	5383,00



+ Modular accumulator MAS 440 double-layered	R009042	5	
Cast iron cover MAS ø 180	R009095-01	1	
Mounting ring	10077	1	
Front variants:			
Door frame, black		SET213178	6508,00
Mounting frame, black 60 mm		SET213179	6525,50
Additional option MAS			
Exchange connecting piece ø 200 mm	R009105		58,00
Exchange connecting piece ø 160 mm	07137		58,00

Energy efficiency index A +





BKH 5.0 flat 42-98 ST

Set consists of:	Art. No.	No.	Price
BKH 5.0 flat 42-98 ST GK FR,		1	
Mounting frame 60 mm / door frame		1	
Chamotte inner lining (FR)		1	



Additional options (for all smoke hood variants)			
EAS (see page7)			1561,50
Reduced price for EAS without display			-148,00
ceramic glass coated (GKB)			170,00
Cast iron inner lining (FR/Guss)			530,00
Catalyst module BKH 5.0	HK000210		871,00
Supply air connection box ø 125 mm included at EAS version	HK000135		170,50
Supply air connection box ø 150 mm	HK000136		188,50

Smoke hood variants:





+ Cast iron dome ø 200 mm	10087	1	
Front variants:			
Door frame, black		SET213265	6106,50
Mounting frame, black 60 mm		SET213266	6125,00
Additional option for cast iron dome			
Cast iron dome ø 180 mm	D004186		0,00



+ Cast iron dome ø 200 mm and cast iron heat exchanger rings	R015006-04	1	
Front variants:			
Door frame, black		SET213267	7048,50
Mounting frame, black 60 mm		SET213268	7067,00



+ Modular accumulator MAS 440 double-layered	R009042	5	
Cast iron cover MAS ø 180	R009095-01	1	
Mounting ring	10077	1	
Front variants:			
Door frame, black		SET213269	7500,00
Mounting frame, black 60 mm		SET213270	7518,50
Additional option MAS			
Exchange connecting piece ø 200 mm	R009105		58,00
Exchange connecting piece ø 160 mm	07137		58,00

Energy efficiency index A +

Indications of abbreviations (see page4)





BKH 5.0 flat 50-82 ST

Set consists of:	Art. No.	No.	Price
BKH 5.0 flat 50-82 ST GK FR,		1	
Mounting frame 60 mm / door frame		1	
Chamotte inner lining (FR)		1	



Additional options (for all smoke hood variants)			
EAS (see page7)			1561,50
Reduced price for EAS without display			-148,00
ceramic glass coated (GKB)			170,00
Cast iron inner lining (FR/Guss)			430,00
Catalyst module BKH 5.0	HK000210		871,00
Supply air connection box ø 125 mm included at EAS version	HK000135		170,50
Supply air connection box ø 150 mm	HK000136		188,50

Smoke hood variants:





+ Cast iron dome ø 200 mm	10087	1	
Front variants:			
Door frame, black	 SET213277		6183,50
Mounting frame, black 60 mm	 SET213278		6198,00
Additional option for cast iron dome			
Cast iron dome ø 180 mm	D004186		0,00



+ Cast iron dome ø 200 mm and cast iron heat exchanger rings	R015006-04	1	
Front variants:			
Door frame, black	 SET213279		7125,50
Mounting frame, black 60 mm	 SET213280		7140,00



+ Modular accumulator MAS 440 double-layered	R009042	5	
Cast iron cover MAS ø 180	R009095-01	1	
Mounting ring	10077	1	
Front variants:			
Door frame, black	 SET213281		7577,00
Mounting frame, black 60 mm	 SET213282		7591,50
Additional option MAS			
Exchange connecting piece ø 200 mm	R009105		58,00
Exchange connecting piece ø 160 mm	07137		58,00

Energy efficiency index A +

Indications of abbreviations (see page4)





BKH 5.0 flat 50-98 ST



Set consists of:	Art. No.	No.	Price
BKH 5.0 flat 50-98 ST GK FR,		1	
Mounting frame 60 mm / door frame		1	
Chamotte inner lining (FR)		1	
Additional options (for all smoke hood variants)			
EAS (see page7)			1561,50
Reduced price for EAS without display			-148,00
ceramic glass coated (GKB)			177,00
Cast iron inner lining (FR/Guss)			530,00
Catalyst module BKH 5.0	HK000210		871,00
Supply air connection box ø 125 mm included at EAS version	HK000135		170,50
Supply air connection box ø 150 mm	HK000136		188,50

Smoke hood variants:





+ Cast iron dome ø 200 mm	10087	1	
Front variants:			
Door frame, black		SET213180	6409,00
Mounting frame, black 60 mm		SET213181	6427,50
Additional option for cast iron dome			
Cast iron dome ø 180 mm	D004186		0,00



+ Cast iron dome ø 200 mm and cast iron heat exchanger rings	R015006-04	1	
Front variants:			
Door frame, black		SET213182	7350,50
Mounting frame, black 60 mm		SET213183	7369,00



+ Modular accumulator MAS 440 double-layered	R009042	5	
Cast iron cover MAS ø 180	R009095-01	1	
Mounting ring	10077	1	
Front variants:			
Door frame, black		SET213186	7802,50
Mounting frame, black 60 mm		SET213187	7821,00
Additional option MAS			
Exchange connecting piece ø 200 mm	R009105		58,00
Exchange connecting piece ø 160 mm	07137		58,00

Energy efficiency index A +

Indications of abbreviations (see page4)

Architektur-Kamin 38/86 lifting door



Set consists of:	Art. No.	No.	Price
AK 38/86 lifting door , single glazing, outlet \varnothing 200 mm		1	
Door frame or mounting frame		1	
Chamotte lining set, bright, for AK 38/86		1	
Hot air convection top for AK 38/86		1	

Additional options			
EAS (see page 11)			1561,50
Reduced price for EAS without display			-148,00
Double glazing			320,00
Counterweights for non-self closing door	49097		46,50
Smoke pipe adapter for horizontal/vertical outlet	BSK7000-129		405,50
Exchange connecting piece \varnothing 180 mm	I019448		61,00

Available variants:

Front variants:				
Door frame, black		SET205844		5711,00
Mounting frame, black, 50 mm		SET205846		5664,50
Mounting frame, black, 70 mm		SET208909		5685,00

Energy efficiency class A

Architektur-Kamin 45/101 lifting door



Set consists of:	Art. No.	No.	Price
AK 45/101 lifting door , single glazing, outlet \varnothing 250 mm		1	
Door frame or mounting frame		1	
Chamotte lining set, bright, for AK 45/101		1	
Hot air convection top for AK 45/101		1	

Additional options			
EAS (see page 11)			1561,50
Reduced price for EAS without display			-148,00
Counterweights for non-self closing door	49097		46,50
Double glazing			405,00
Smoke pipe adapter for horizontal outlet	I019490		299,00
Exchange connecting piece \varnothing 180 mm	I019448		61,00
Exchange connecting piece \varnothing 200 mm	I019449		61,00

Available variants:

Front variants:				
Door frame, black		SET205850		6082,00
Mounting frame, black, 50 mm		SET205852		6034,00
Mounting frame, black, 70 mm		SET208912		6070,00

Energy efficiency class A





Architektur-Kamin 53/121 lifting door

Set consists of:	Art. No.	No.	Price
AK 53/121 lifting door , single glazing, outlet \varnothing 250 mm		1	
Door frame or mounting frame		1	
Chamotte lining set, bright, for AK 53/121		1	

Additional options			
Counterweights for non-self closing door	49097		46,50
Double glazing			510,00
Smoke pipe adapter for horizontal outlet	I019490		299,00
Exchange connecting piece \varnothing 200 mm	I019449		61,00

Available variants:

Front variants:			
Door frame, black		SET205860	6666,50
Mounting frame, black, 50 mm		SET205862	6625,00
Mounting frame, black, 70 mm		SET208915	6644,00

Energy efficiency class A





Architektur-Kamin 53/166 lifting door

Set consists of:	Art. No.	No.	Price
AK 53/166 lifting door , single glazing, outlet \varnothing 250 mm		1	
Door frame or mounting frame		1	
Chamotte lining set, bright, for AK 53/166		1	

Additional options			
Counterweights for non-self closing door	49097		46,50
Double glazing			670,00
Smoke pipe adapter for horizontal outlet	I019490		299,00
Exchange connecting piece \varnothing 200 mm	I019449		61,00

Available variants:

Front variants:			
Door frame, black		SET205872	7583,00
Mounting frame, black, 50 mm		SET205874	7513,00
Mounting frame, black, 70 mm		SET208919	7558,50

Energy efficiency class A

Stil-Kamin 51/67 side-opening door, single glazing



Set consists of:	Art. No.	No.	Price
Stil-Kamin 51/67, side-opening door, single glazing, outlet ø 250 mm		1	
Door frame or mounting frame		1	
Chamotte lining kit (rill optic)		1	
hot air convection top		1	

Additional options			
EAS (see page 11)			1561,50
Reduced price for EAS without display			-148,00
Double glazing			289,00
Smoke pipe adapter for horizontal outlet	I019490		299,00
Exchange connecting piece ø 180 mm	I019448		61,00
Exchange connecting piece ø 200 mm	I019449		61,00

Available variants:

Front variants			
Door frame, black		SET210535	3990,50

Energy efficiency index A +

Stil-Kamin 51/67 lifting door, single glazing



Set consists of:	Art. No.	No..	Price
Stil-Kamin 51/67, lifting door, single glazing, outlet ø 250 mm		1	
Door frame or mounting frame		1	
Chamotte lining kit (rill optic)		1	
hot air convection top		1	

Additional options			
EAS (see page 11)			1561,50
Reduced price for EAS without display			-148,00
Counterweights for non-self closing door	49097		46,50
Double glazing			289,00
Smoke pipe adapter for horizontal outlet	I019490		299,00
Exchange connecting piece ø 180 mm	I019448		61,00
Exchange connecting piece ø 200 mm	I019449		61,00

Available variants:

Front variants:			
Door frame, black		SET210537	4844,00
Mounting frame, black, 50 mm		SET210539	4844,00
Mounting frame, black 70 mm		SET210541	4908,00

Energy efficiency index A +





Stil-Kamin 53/88 lifting door, single glazing

Set consists of:	Art. No.	No.	Price
Stil-Kamin 53/88 lifting door , single glazing		1	
Door frame or mounting frame		1	
Chamotte lining set (brick plates)		1	



Additional options (for all smoke hood variants)			
EAS (see page 11)			1561,50
Reduced price for EAS without display			-148,00
Double glazing			385,00
Counterweights for non-self closing door	49097		46,50
Inner linings (smooth)	I049224		-87,50

Smoke hood variants:





Cast iron hot air hood ø 200 mm	R014022-01	1	
Front variants:			
Door frame, black	 SET211008		5623,00
Mounting frame, black, 50 mm	 SET211010		5617,00
Mounting frame, black, 70 mm	 SET211012		5646,00
Additional option for steel smoke hood vertical			
Cast iron hot air hood ø 250 mm	R014022-02		0,00
Cast iron hot air hood ø 180 mm	R014022-03		0,00



+Cast iron dome ø 200 mm	10087	1	
Front variants:			
Door frame, black	 SET209972		5454,00
Mounting frame, black, 50 mm	 SET209974		5448,00
Mounting frame, black, 70 mm	 SET209978		5477,00
Additional option for cast iron dome			
Cast iron dome ø 180 mm	D004186		0,00



+ Modular accumulator MAS 440 double-layered	R009042	5	
Cast iron cover MAS ø 180	R009095-01	1	
Mounting ring	10077	1	
Front variants:			
Door frame, black	 SET209979		6847,50
Mounting frame, black, 50 mm	 SET209981		6841,50
Mounting frame, black, 70 mm	 SET209983		6870,50
Additional option MAS			
Exchange connecting piece ø 200 mm	R009105		58,00
Exchange connecting piece ø 160 mm	07137		58,00

Energy efficiency class A

Stil-Kamin 62/76 lifting door, single glazing





Set consists of:	Art. No.	No.	Price
Stil-Kamin 62/76 lifting door, single glazing		1	
Door frame or mounting frame		1	
Chamotte lining set (brick plates)		1	



Additional options (for all smoke hood variants)			
EAS (see page 11)			1561,50
Reduced price for EAS without display			-148,00
Double glazing			417,00
Counterweights for non-self closing door	49097		46,50
Inner linings (smooth)	I003623		-102,50

Smoke hood variants:





Cast iron hot air hood ø 200 mm	R014022-01	1	
Front variants:			
Door frame, black	 SET210356		5716,00
Mounting frame, black, 50 mm	 SET210358		5654,00
Mounting frame, black, 70 mm	 SET210360		5707,50
Additional option for steel smoke hood vertical			
Cast iron hot air hood ø 250 mm	R014022-02		0,00
Cast iron hot air hood ø 180 mm	R014022-03		0,00



+Cast iron dome ø 200 mm	10087	1	
Front variants:			
Door frame, black	 SET209930		5547,00
Mounting frame, black, 50 mm	 SET209932		5485,00
Mounting frame, black, 70 mm	 SET209936		5538,50
Additional option for cast iron dome			
Cast iron dome ø 180 mm	D004186		0,00



+ Modular accumulator MAS 440 double-layered	R009042	5	
Cast iron cover MAS ø 180	R009095-01	1	
Mounting ring	10077	1	
Front variants:			
Door frame, black	 SET209937		6940,50
Mounting frame, black, 50 mm	 SET209939		6878,50
Mounting frame, black, 70 mm	 SET209941		6932,00
Additional option MAS			
Exchange connecting piece ø 200 mm	R009105		58,00
Exchange connecting piece ø 160 mm	07137		58,00

Energy efficiency class A





Stil-Kamin 62/76 k lifting door, single glazing

Set consists of:	Art. No.	No.	Price
Stil-Kamin 62/76 k lifting door , single glazing, outlet \varnothing 200 mm		1	
Door frame or mounting frame		1	
Chamotte lining set (brick plates)		1	

Additional options			
Double glazing			417,00
Counterweights for non-self closing door	49097		46,50
Exchange connecting piece \varnothing 180 mm	I058043		77,00

Available variants:

Front variants:				
Door frame, black		SET205295		5157,00
Mounting frame, black, 50 mm		SET205297		5095,00
Mounting frame, black, 70 mm		SET208902		5148,50

Energy efficiency class A

Stil-Kamin 75/90 lifting door, single glazing





Set consists of:	Art. No.	No.	Price
Stil-Kamin 75/90 lifting door, single glazing		1	
Door frame or mounting frame		1	
Chamotte lining set (brick plates)		1	



Additional options (for all smoke hood variants)			
EAS (see page 11)			1561,50
Reduced price for EAS without display			-148,00
Double glazing			535,00
Counterweights for non-self closing door	49097		46,50
Inner linings (smooth)	40987		-102,50

Smoke hood variants:





Cast iron hot air hood ø 200 mm	R014022-01	1	
Front variants:			
Door frame, black	 SET211015		7470,50
Mounting frame, black, 50 mm	 SET211017		7410,00
Mounting frame, black, 70 mm	 SET211018		7484,50
Additional option for steel smoke hood vertical			
Cast iron hot air hood ø 250 mm	R014022-02		0,00
Cast iron hot air hood ø 180 mm	R014022-03		0,00



+ Cast iron dome ø 200 mm	10087	1	
Front variants:			
Door frame, black	 SET209944		7301,50
Mounting frame, black, 50 mm	 SET209946		7241,00
Mounting frame, black, 70 mm	 SET209950		7315,50
Additional option for cast iron dome			
Cast iron dome ø 180 mm	D004186		0,00



+ Modular accumulator MAS 440 double-layered	R009042	5	
Cast iron cover MAS ø 180	R009095-01	1	
Mounting ring	10077	1	
Front variants:			
Door frame, black	 SET209951		8695,00
Mounting frame, black, 50 mm	 SET209953		8634,50
Mounting frame, black, 70 mm	 SET209955		8709,00
Additional option MAS			
Exchange connecting piece ø 200 mm	R009105		58,00
Exchange connecting piece ø 160 mm	07137		58,00

Energy efficiency class A



BKH 5.0 Tunnel 42-50 DT-DT

Set consists of:	Art. No.	No.	Price
BKH 5.0 Tunnel 42-50 DT-DT GK FR,		1	
Mounting bracket / door frame		1	
Chamotte inner lining (FR)		1	

Additional options (for all smoke hood variants)			
EAS (see page7)			1561,50
Reduced price for EAS without display			-148,00
ceramic glass coated (GKB)			189,00
Cast iron inner lining (FR/Guss)			247,00
Catalyst module BKH 5.0	HK000210		871,00
Supply air connection box ø 125 mm included at EAS version	HK000135		170,50
Supply air connection box ø 150 mm	HK000136		188,50
Heat protection panel for one side	HK014251		121,50

Attention: Tunnel inserts can only be operated on one side, the other side is equipped with an inspection handle. With the EAS version, only one door contact switch is installed on the operating side.

Smoke hood variants:



+ Cast iron dome ø 200 mm	10087	1	
Front variants:			
Mounting bracket		SET213188	4761,50
Door frame, black		SET213189	5041,50
Additional option for cast iron dome			
Cast iron dome ø 180 mm	D004186		0,00



+ Cast iron dome ø 200 mm and cast iron heat exchanger rings	R015006-02	1	
Front variants:			
Mounting bracket		SET213190	5232,50
Door frame, black		SET213191	5512,50



+ Cast iron dome ø 180 mm low	D016042	1	
Front variants:			
Mounting bracket		SET213192	5012,50
Door frame, black		SET213193	5292,50



+ Modular accumulator MAS 440 double-layered	R009042	5	
Cast iron cover MAS ø 180	R009095-01	1	
Mounting ring	10077	1	
Front variants:			
Mounting bracket		SET213194	6155,00
Door frame, black		SET213195	6435,00
Additional option MAS			
Exchange connecting piece ø 200 mm	R009105		58,00
Exchange connecting piece ø 160 mm	07137		58,00

Energy efficiency index A +

BKH 5.0 Tunnel 42-50 ST-DT





Set consists of:	Art. No.	No.	Price
BKH 5.0 Tunnel 42-50 ST-DT GK FR,		1	
Mounting frame 60 mm / door frame		1	
Chamotte inner lining (FR)		1	

Additional options (for all smoke hood variants)			
EAS (see page 7)			1561,50
Reduced price for EAS without display			-148,00
ceramic glass coated (GKB)			189,00
Cast iron inner lining (FR/Guss)			247,00
Catalyst module BKH 5.0	HK000210		871,00
Supply air connection box ø 125 mm included at EAS version	HK000135		170,50
Supply air connection box ø 150 mm	HK000136		188,50
Heat protection panel for one side	HK014251		121,50



Attention: Tunnel inserts can only be operated on one side, the other side is equipped with an inspection handle. With the EAS version, only one door contact switch is installed on the operating side. With ST-DT and ST-KT, the ST side is therefore the operable side.

Smoke hood variants:





+ Cast iron dome ø 200 mm	10087	1	
Front variants:			
Door frame, black		SET213196	6175,00
Mounting frame, black 60 mm		SET213197	6056,50
Additional option for cast iron dome			
Cast iron dome ø 180 mm	D004186		0,00





+ Cast iron dome ø 200 mm and cast iron heat exchanger rings	R015006-02	1	
Front variants:			
Door frame, black		SET213198	6646,00
Mounting frame, black 60 mm		SET213199	6527,50



+ Cast iron dome ø 180 mm low	D016042	1	
Front variants:			
Door frame, black		SET213200	6426,00
Mounting frame, black 60 mm		SET213201	6307,50



+ Modular accumulator MAS 440 double-layered	R009042	5	
Cast iron cover MAS ø 180	R009095-01	1	
Mounting ring	10077	1	
Front variants:			
Door frame, black		SET213202	7568,50
Mounting frame, black 60 mm		SET213203	7450,00
Additional option MAS			
Exchange connecting piece ø 200 mm	R009105		58,00
Exchange connecting piece ø 160 mm	07137		58,00

Energy efficiency index A +



BKH 5.0 Tunnel 42-66 DT-DT

Set consists of:	Art. No.	No.	Price
BKH 5.0 Tunnel 42-66 DT-DT GK FR,		1	
Mounting bracket / door frame		1	
Chamotte inner lining (FR)		1	

Additional options (for all smoke hood variants)			
EAS (see page 7)			1561,50
Reduced price for EAS without display			-148,00
ceramic glass coated (GKB)			212,00
Cast iron inner lining (FR/Guss)			259,00
Catalyst module BKH 5.0	HK000210		871,00
Supply air connection box ø 125 mm included at EAS version	HK000135		170,50
Supply air connection box ø 150 mm	HK000136		188,50
Heat protection panel for one side	HK014251		121,50

Attention: Tunnel inserts can only be operated on one side, the other side is equipped with an inspection handle. With the EAS version, only one door contact switch is installed on the operating side.

Smoke hood variants:



+ Cast iron dome ø 200 mm	10087	1	
Front variants:			
Mounting bracket		SET213204	4973,00
Door frame, black		SET213205	5267,00
Additional option for cast iron dome			
Cast iron dome ø 180 mm	D004186		0,00



+ Cast iron dome ø 200 mm and cast iron heat exchanger rings	R015006-02	1	
Front variants:			
Mounting bracket		SET213206	5444,00
Door frame, black		SET213207	5738,00



+ Cast iron dome ø 180 mm low	D016042	1	
Front variants:			
Mounting bracket		SET213208	5224,00
Door frame, black		SET213209	5518,00



+ Modular accumulator MAS 440 double-layered	R009042	5	
Cast iron cover MAS ø 180	R009095-01	1	
Mounting ring	10077	1	
Front variants:			
Mounting bracket		SET213210	6366,50
Door frame, black		SET213211	6660,50
Additional option MAS			
Exchange connecting piece ø 200 mm	R009105		58,00
Exchange connecting piece ø 160 mm	07137		58,00

Energy efficiency index A +

BKH 5.0 Tunnel 42-66 ST-DT





Set consists of:	Art. No.	No.	Price
BKH 5.0 Tunnel 42-66 ST-DT GK FR,		1	
Mounting frame 60 mm / door frame		1	
Chamotte inner lining (FR)		1	

Additional options (for all smoke hood variants)			
EAS (see page 7)			1561,50
Reduced price for EAS without display			-148,00
ceramic glass coated (GKB)			212,00
Cast iron inner lining (FR/Guss)			259,00
Catalyst module BKH 5.0	HK000210		871,00
Supply air connection box ø 125 mm included at EAS version	HK000135		170,50
Supply air connection box ø 150 mm	HK000136		188,50
Heat protection panel for one side	HK014251		121,50



Attention: Tunnel inserts can only be operated on one side, the other side is equipped with an inspection handle. With the EAS version, only one door contact switch is installed on the operating side. With ST-DT and ST-KT, the ST side is therefore the operable side.

Smoke hood variants:





+ Cast iron dome ø 200 mm	10087	1	
Front variants:			
Door frame, black		SET213212	6409,00
Mounting frame, black 60 mm		SET213213	6279,50
Additional option for cast iron dome			
Cast iron dome ø 180 mm	D004186		0,00





+ Cast iron dome ø 200 mm and cast iron heat exchanger rings	R015006-02	1	
Front variants:			
Door frame, black		SET213214	6880,00
Mounting frame, black 60 mm		SET213215	6750,50



+ Cast iron dome ø 180 mm low	D016042	1	
Front variants:			
Door frame, black		SET213216	6660,00
Mounting frame, black 60 mm		SET213217	6530,50



+ Modular accumulator MAS 440 double-layered	R009042	5	
Cast iron cover MAS ø 180	R009095-01	1	
Mounting ring	10077	1	
Front variants:			
Door frame, black		SET213218	7802,50
Mounting frame, black 60 mm		SET213219	7673,00
Additional option MAS			
Exchange connecting piece ø 200 mm	R009105		58,00
Exchange connecting piece ø 160 mm	07137		58,00

Energy efficiency index A +



BKH 5.0 Tunnel 42-98 ST-KT



Set consists of:	Art. No.	No.	Price
BKH 5.0 Tunnel 42-98 ST-KT GK FR,		1	
Mounting frame 60 mm / door frame		1	
Chamotte inner lining (FR)		1	

Additional options (for all smoke hood variants)			
EAS (see page7)			1561,50
Reduced price for EAS without display			-148,00
ceramic glass coated (GKB)			340,00
Cast iron inner lining (FR/Guss)			282,50
Catalyst module BKH 5.0	HK000210		871,00
Supply air connection box ø 125 mm included at EAS version	HK000135		170,50
Supply air connection box ø 150 mm	HK000136		188,50



Attention: Tunnel inserts can only be operated on one side, the other side is equipped with an inspection handle. With the EAS version, only one door contact switch is installed on the operating side.
With ST-DT and ST-KT, the ST side is therefore the operable side.

Smoke hood variants:





+ Cast iron dome ø 200 mm	10087	1	
Front variants:			
Door frame, black		SET213271	7656,00
Mounting frame, black 60 mm		SET213272	7693,00
Additional option for cast iron dome			
Cast iron dome ø 180 mm	D004186		0,00



+ Cast iron dome ø 200 mm and cast iron heat exchanger rings	R015006-04	1	
Front variants:			
Door frame, black		SET213273	8598,00
Mounting frame, black 60 mm		SET213274	8635,00



+ Modular accumulator MAS 440 double-layered	R009042	5	
Cast iron cover MAS ø 180	R009095-01	1	
Mounting ring	10077	1	
Front variants:			
Door frame, black		SET213275	9049,50
Mounting frame, black 60 mm		SET213276	9086,50
Additional option MAS			
Exchange connecting piece ø 200 mm	R009105		58,00
Exchange connecting piece ø 160 mm	07137		58,00

Energy efficiency index A +

Indications of abbreviations (see page4)

BKH 5.0 Tunnel 50-82 ST-KT



Set consists of:	Art. No.	No.	Price
BKH 5.0 Tunnel 50-82 ST-KT GK FR,		1	
Mounting frame 60 mm / door frame		1	
Chamotte inner lining (FR)		1	

Additional options (for all smoke hood variants)			
EAS (see page7)			1561,50
Reduced price for EAS without display			-148,00
ceramic glass coated (GKB)			340,00
Cast iron inner lining (FR/Guss)			282,50
Catalyst module BKH 5.0	HK000210		871,00
Supply air connection box ø 125 mm included at EAS version	HK000135		170,50
Supply air connection box ø 150 mm	HK000136		188,50



Attention: Tunnel inserts can only be operated on one side, the other side is equipped with an inspection handle. With the EAS version, only one door contact switch is installed on the operating side.
With ST-DT and ST-KT, the ST side is therefore the operable side.

Smoke hood variants:





+ Cast iron dome ø 200 mm	10087	1	
Front variants:			
Door frame, black		SET213283	7843,00
Mounting frame, black 60 mm		SET213284	7872,00
Additional option for cast iron dome			
Cast iron dome ø 180 mm	D004186		0,00



+ Cast iron dome ø 200 mm and cast iron heat exchanger rings	R015006-04	1	
Front variants:			
Door frame, black		SET213285	8785,00
Mounting frame, black 60 mm		SET213286	8814,00



+ Modular accumulator MAS 440 double-layered	R009042	5	
Cast iron cover MAS ø 180	R009095-01	1	
Mounting ring	10077	1	
Front variants:			
Door frame, black		SET213287	9236,50
Mounting frame, black 60 mm		SET213288	9265,50
Additional option MAS			
Exchange connecting piece ø 200 mm	R009105		58,00
Exchange connecting piece ø 160 mm	07137		58,00

Energy efficiency index A +

Indications of abbreviations (see page4)



BKH 5.0 Tunnel 50-98 ST-KT



Set consists of:	Art. No.	No.	Price
BKH 5.0 Tunnel 50-98 ST-KT GK FR,		1	
Mounting frame 60 mm / door frame		1	
Chamotte inner lining (FR)		1	

Additional options (for all smoke hood variants)			
EAS (see page7)			1561,50
Reduced price for EAS without display			-148,00
ceramic glass coated (GKB)			354,00
Cast iron inner lining (FR/Guss)			282,50
Catalyst module BKH 5.0	HK000210		871,00
Supply air connection box ø 125 mm included at EAS version	HK000135		170,50
Supply air connection box ø 150 mm	HK000136		188,50



Attention: Tunnel inserts can only be operated on one side, the other side is equipped with an inspection handle. With the EAS version, only one door contact switch is installed on the operating side.
With ST-DT and ST-KT, the ST side is therefore the operable side.

Smoke hood variants:





+ Cast iron dome ø 200 mm	10087	1	
Front variants:			
Door frame, black		SET213220	8069,00
Mounting frame, black 60 mm		SET213221	8106,00
Additional option for cast iron dome			
Cast iron dome ø 180 mm	D004186		0,00



+ Cast iron dome ø 200 mm and cast iron heat exchanger rings	R015006-04	1	
Front variants:			
Door frame, black		SET213222	9010,50
Mounting frame, black 60 mm		SET213223	9047,50



+ Modular accumulator MAS 440 double-layered	R009042	5	
Cast iron cover MAS ø 180	R009095-01	1	
Mounting ring	10077	1	
Front variants:			
Door frame, black		SET213226	9462,50
Mounting frame, black 60 mm		SET213227	9499,50
Additional option MAS			
Exchange connecting piece ø 200 mm	R009105		58,00
Exchange connecting piece ø 160 mm	07137		58,00

Energy efficiency index A +

Indications of abbreviations (see page4)



Architektur-Kamin Tunnel 38/86 lifting/tilting door



Set consists of:	Art. No.	No.	Price
AK Tunnel/double face 38/86, lifting/tilting door, single glazing, outlet ø 200 mm		1	
Door frame or mounting frame		2	
Chamotte lining set, bright, for AK Tunnel/double face 38/86		1	
Hot air convection top AK Tunnel 38/86		1	

Additional options			
EAS (see page 11)			1561,50
Reduced price for EAS without display			-148,00
Counterweights for open-door use (only one side possible)	49097		46,50
Double glazing (also one side only available on request)			640,00
Smoke pipe adapter for horizontal/vertical outlet	BSK7000-129		405,50
Exchange connecting piece ø 180 mm	I019448		61,00
Lifting doors on both sides available upon request			

Available variants:

Front variants:			
Door frame, black		SET205887	7900,50
Mounting frame, black, 50 mm		SET205889	7807,50
Mounting frame, black, 70 mm		SET208910	7848,50

Energy efficiency class A





Architektur-Kamin Tunnel 45/101 lifting/tilting door

Set consists of:	Art. No.	No.	Price
AK Tunnel/double face 45/101, lifting/tilting door, single glazing, outlet ø 250 mm		1	
Door frame or mounting frame		2	
Chamotte lining set, bright, for AK Tunnel/double face 45/101		1	
Hot air convection top AK Tunnel 45/101		1	

Additional options			
EAS (see page 11)			1561,50
Reduced price for EAS without display			-148,00
Counterweights for open-door use (only one side possible)	49097		46,50
Double glazing (also one side only available on request)			810,00
Smoke pipe adapter for horizontal outlet	I019490		299,00
Exchange connecting piece ø 180 mm	I019448		61,00
Exchange connecting piece ø 200 mm	I019449		61,00
Lifting doors on both sides available upon request			

Available variants:

Front variants:				
Door frame, black		SET205899		8471,00
Mounting frame, black, 50 mm		SET205901		8375,00
Mounting frame, black, 70 mm		SET208913		8447,00

Energy efficiency class A



Architektur-Kamin Tunnel 53/121 lifting/tilting door

Set consists of:	Art. No.	No.	Price
AK Tunnel/double face 53/121, lifting/tilting door, single glazing, outlet ø 250 mm		1	
Door frame or mounting frame		2	
Chamotte lining set, bright, for AK Tunnel/double face 53/121		1	

Additional options			
Counterweights for open-door use (only one side possible)	49097		46,50
Double glazing (also one side only available on request)			1020,00
Smoke pipe adapter for horizontal outlet	I019490		299,00
Exchange connecting piece ø 200 mm	I019449		61,00
Lifting doors on both sides available upon request			

Available variants:

Front variants:			
Door frame, black		SET205911	9143,00
Mounting frame, black, 50 mm		SET205913	9060,00
Mounting frame, black, 70 mm		SET208916	9098,00

Energy efficiency class A

Architektur-Kamin Tunnel 53/166 lifting/tilting door



Set consists of:	Art. No.	No.	Price
AK Tunnel/double face 53/166, lifting/tilting door, single glazing, outlet ø 250 mm		1	
Door frame or mounting frame		2	
Chamotte lining set, bright, for AK Tunnel/double face 53/166		1	

Additional options			
Counterweights for open-door use (only one side possible)	49097		46,50
Double glazing (also one side only available on request)			1340,00
Smoke pipe adapter for horizontal outlet	I019490		299,00
Exchange connecting piece ø 200 mm	I019449		61,00
Lifting doors on both sides available upon request			

Available variants:

Front variants:			
Door frame, black		SET205935	10441,50
Mounting frame, black, 50 mm		SET205937	10301,50
Mounting frame, black, 70 mm		SET208920	10392,50

Energy efficiency class A





Stil-Kamin Tunnel 51/67 lifting door/side opening door

Set consists of:	Art. No.	No.	Price
Stil-Kamin Tunnel 51/67, lifting door/side opening door, single glazing, outlet ø 250 mm		1	
Door frame or mounting frame (DT doors with door frames by default)		2	
Grooved chamotte lining		1	
hot air convection top		1	

Additional options			
EAS (see page 11)			1706,50
Reduced price for EAS without display			-148,00
Counterweights for non-self closing door	49097		46,50
Double glazing (also one side only available on request)			578,00
Smoke pipe adapter for horizontal outlet	I019490		299,00
Exchange connecting piece ø 180 mm	I019448		61,00
Exchange connecting piece ø 200 mm	I019449		61,00
Revision handle	O2426		130,00
Lifting doors on both sides available upon request			

Available variants:

Front variants:			
Door frame, black		SET210546	7371,50
Door frame, black DT Mounting frame, black ST 50 mm		SET210548	7371,50
Door frame, black DT Mounting frame, black ST 70 mm		SET210550	7435,50

Energy efficiency index A +



Stil-KaminTunnel 53/88 lifting/tilting door



Set consists of:	Art. No.	No.	Price
Stil-KaminTunnel 53/88, lifting/tilting door, single glazing, outlet ø 250 mm		1	
Door frame or mounting frame		2	
Inner lining set for 53/88		1	

Additional options			
Counterweights for open-door use (lifting door only)	49097		46,50
Double glazing (also one side only available on request)			770,00
Spare connecting piece ø 180 mm	I019448		61,00
Exchange connecting piece ø 200 mm	I019449		61,00
Lifting doors on both sides available upon request			

Available variants:

Front variants:				
Door frame, black		SET207104		7837,00
Mounting frame, black, 50 mm		SET207106		7825,00
Mounting frame, black, 70 mm		SET208907		7883,00

Energy efficiency class A



Stil-KaminTunnel 62/76 lifting/tilting door



Set consists of:	Art. No.	No.	Price
Stil-KaminTunnel 62/76, lifting/tilting door, single glazing, outlet ø 250 mm		1	
Door frame or mounting frame		2	
Inner lining set for 62/76		1	

Additional options			
Counterweights for open-door use (lifting door only)	49097		46,50
Double glazing (also one side only available on request)			834,00
Spare connecting piece ø 180 mm	I019448		61,00
Exchange connecting piece ø 200 mm	I019449		61,00
Lifting doors on both sides available upon request			

Available variants:

Front variants:				
Door frame, black		SET205826		8077,00
Mounting frame, black, 50 mm		SET205828		7953,00
Mounting frame, black, 70 mm		SET208901		8060,00

Energy efficiency class A





Stil-KaminTunnel 75/90 lifting/tilting door

Set consists of:	Art. No.	No.	Price
Stil-KaminTunnel 75/90, lifting/tilting door, single glazing, outlet ø 250 mm		1	
Door frame or mounting frame		2	
Inner lining set for 75/90		1	

Additional options			
Counterweights for open-door use (lifting door only)	49097		46,50
Double glazing (also one side only available on request)			1070,00
Spare connecting piece ø 180 mm	I019448		61,00
Exchange connecting piece ø 200 mm	I019449		61,00
Lifting doors on both sides available upon request			

Available variants:

Front variants:			
Door frame, black		SET205838	9144,50
Mounting frame, black, 50 mm		SET205840	9023,50
Mounting frame, black, 70 mm		SET208904	9172,50

Energy efficiency class A

flat

Tunnel

Eck

Panorama





BKH 5.0 Eck 42-66-42 DTL

Set consists of:	Art. No.	No.	Price
BKH 5.0 Eck 42-66-42 DTL GK FR,		1	
Mounting bracket / Door frame		1	
Chamotte inner lining (FR)		1	

Additional options (for all smoke hood variants)			
EAS (see page11)			1561,50
Reduced price for EAS without display			-148,00
ceramic glass coated (GKB)			250,00
Cast iron inner lining (FR/Guss)			310,00
Catalyst module BKH 5.0	HK000210		871,00
Supply air connection box ø 125 mm included at EAS version	HK000135		170,50
Supply air connection box ø 150 mm	HK000136		188,50
Heat protection panel with one side wall	HK021450		270,00

Smoke hood variants:



+ Cast iron dome ø 200 mm	10087	1	
Front variants:			
Mounting bracket	 SET213289		4308,00
Door frame, black	 SET213290		4533,00
Additional option for cast iron dome			
Cast iron dome ø 180 mm	D004186		0,00



+ Cast iron dome ø 200 mm and cast iron heat exchanger rings	R015006-02	1	
Front variants:			
Mounting bracket	 SET213291		4779,00
Door frame, black	 SET213292		5004,00



+ Cast iron dome ø 180 mm low	D016042	1	
Front variants:			
Mounting bracket	 SET213293		4559,00
Door frame, black	 SET213294		4784,00



+ Modular accumulator MAS 440 double-layered	R009042	5	
Cast iron cover MAS ø 180	R009095-01	1	
Mounting ring	10077	1	
Front variants:			
Mounting bracket	 SET213295		5701,50
Door frame, black	 SET213296		5926,50
Additional option MAS			
Exchange connecting piece ø 200 mm	R009105		58,00
Exchange connecting piece ø 160 mm	07137		58,00

Energy efficiency index A +

BKH 5.0 Eck 42-66-42 DTR



Set consists of:	Art. No.	No.	Price
BKH 5.0 Eck 42-66-42 DTR GK FR,		1	
Mounting bracket / Door frame		1	
Chamotte inner lining (FR)		1	

Additional options (for all smoke hood variants)			
EAS (see page11)			1561,50
Reduced price for EAS without display			-148,00
ceramic glass coated (GKB)			250,00
Cast iron inner lining (FR/Guss)			310,00
Catalyst module BKH 5.0	HK000210		871,00
Supply air connection box ø 125 mm included at EAS version	HK000135		170,50
Supply air connection box ø 150 mm	HK000136		188,50
Heat protection panel with one side wall	HK021450		270,00

Smoke hood variants:



+ Cast iron dome ø 200 mm		10087	1	
Front variants:				
Mounting bracket		SET213297		4308,00
Door frame, black		SET213298		4533,00
Additional option for cast iron dome				
Cast iron dome ø 180 mm		D004186		0,00



+ Cast iron dome ø 200 mm and cast iron heat exchanger rings		R015006-02	1	
Front variants:				
Mounting bracket		SET213299		4779,00
Door frame, black		SET213300		5004,00



+ Cast iron dome ø 180 mm low		D016042	1	
Front variants:				
Mounting bracket		SET213301		4559,00
Door frame, black		SET213302		4784,00



+ Modular accumulator MAS 440 double-layered		R009042	5	
Cast iron cover MAS ø 180		R009095-01	1	
Mounting ring		10077	1	
Front variants:				
Mounting bracket		SET213303		5701,50
Door frame, black		SET213304		5926,50
Additional option MAS				
Exchange connecting piece ø 200 mm		R009105		58,00
Exchange connecting piece ø 160 mm		07137		58,00

Energy efficiency index A +



BKH 5.0 Eck 42-66-42 STL

Set consists of:	Art. No.	No.	Price
BKH 5.0 Eck 42-66-42 STL GK FR,		1	
Mounting frame 60 mm		1	
Chamotte inner lining (FR)		1	

Additional options (for all smoke hood variants)			
EAS (see page11)			1561,50
Reduced price for EAS without display			-148,00
ceramic glass coated (GKB)			250,00
Cast iron inner lining (FR/Guss)			310,00
Catalyst module BKH 5.0	HK000210		871,00
Supply air connection box ø 125 mm included at EAS version	HK000135		170,50
Supply air connection box ø 150 mm	HK000136		188,50
Heat protection panel with one side wall	HK021450		270,00

Smoke hood variants:



+ Cast iron dome ø 200 mm	10087	1	
Front variants:			
Mounting frame, black 60 mm	 SET213305		5288,00
Additional option for cast iron dome			
Cast iron dome ø 180 mm	D004186		0,00



+ Cast iron dome ø 200 mm and cast iron heat exchanger rings	R015006-02	1	
Front variants:			
Mounting frame, black 60 mm	 SET213306		5759,00



+ Modular accumulator MAS 440 double-layered	R009042	5	
Cast iron cover MAS ø 180	R009095-01	1	
Mounting ring	10077	1	
Front variants:			
Mounting frame, black 60 mm	 SET213307		6681,50
Additional option MAS			
Exchange connecting piece ø 200 mm	R009105		58,00
Exchange connecting piece ø 160 mm	07137		58,00

Energy efficiency index A +

BKH 5.0 Eck 42-66-42 STR



Set consists of:	Art. No.	No.	Price
BKH 5.0 Eck 42-66-42 STR GK FR,		1	
Mounting frame 60 mm		1	
Chamotte inner lining (FR)		1	

Additional options (for all smoke hood variants)			
EAS (see page11)			1561,50
Reduced price for EAS without display			-148,00
ceramic glass coated (GKB)			250,00
Cast iron inner lining (FR/Guss)			310,00
Catalyst module BKH 5.0	HK000210		871,00
Supply air connection box ø 125 mm included at EAS version	HK000135		170,50
Supply air connection box ø 150 mm	HK000136		188,50
Heat protection panel with one side wall	HK021450		270,00

Smoke hood variants:



+ Cast iron dome ø 200 mm	10087	1	
Front variants:			
Mounting frame, black 60 mm	SET213308		5288,00
Additional option for cast iron dome			
Cast iron dome ø 180 mm	D004186		0,00



+ Cast iron dome ø 200 mm and cast iron heat exchanger rings	R015006-02	1	
Front variants:			
Mounting frame, black 60 mm	SET213309		5759,00



+ Modular accumulator MAS 440 double-layered	R009042	5	
Cast iron cover MAS ø 180	R009095-01	1	
Mounting ring	10077	1	
Front variants:			
Mounting frame, black 60 mm	SET213310		6681,50
Additional option MAS			
Exchange connecting piece ø 200 mm	R009105		58,00
Exchange connecting piece ø 160 mm	07137		58,00

Energy efficiency index A +



BKH 5.0 Eck 42-98-42 STL

Set consists of:	Art. No.	No.	Price
BKH 5.0 Eck 42-98-42 STL GK FR,		1	
Mounting frame 60 mm		1	
Chamotte inner lining (FR)		1	

Additional options (for all smoke hood variants)			
EAS (see page11)			1561,50
Reduced price for EAS without display			-148,00
ceramic glass coated (GKB)			150,00
Cast iron inner lining (FR/Guss)			330,00
Catalyst module BKH 5.0	HK000210		871,00
Supply air connection box ø 125 mm included at EAS version	HK000135		170,50
Supply air connection box ø 150 mm	HK000136		188,50

Smoke hood variants:



+ Cast iron dome ø 200 mm	10087	1	
Front variants:			
Mounting frame, black 60 mm	 SET213311		6064,00
Additional option for cast iron dome			
Cast iron dome ø 180 mm	D004186		0,00



+ Cast iron dome ø 200 mm and cast iron heat exchanger rings	R015006-04	1	
Front variants:			
Mounting frame, black 60 mm	 SET213312		6535,00



+ Modular accumulator MAS 440 double-layered	R009042	5	
Cast iron cover MAS ø 180	R009095-01	1	
Mounting ring	10077	1	
Front variants:			
Mounting frame, black 60 mm	 SET213313		7457,50
Additional option MAS			
Exchange connecting piece ø 200 mm	R009105		58,00
Exchange connecting piece ø 160 mm	07137		58,00

Energy efficiency index A +

BKH 5.0 Eck 42-98-42 STR



Set consists of:	Art. No.	No.	Price
BKH 5.0 Eck 42-98-42 STR GK FR,		1	
Mounting frame 60 mm		1	
Chamotte inner lining (FR)		1	

Additional options (for all smoke hood variants)			
EAS (see page11)			1561,50
Reduced price for EAS without display			-148,00
ceramic glass coated (GKB)			150,00
Cast iron inner lining (FR/Guss)			330,00
Catalyst module BKH 5.0	HK000210		871,00
Supply air connection box ø 125 mm included at EAS version	HK000135		170,50
Supply air connection box ø 150 mm	HK000136		188,50

Smoke hood variants:



+ Cast iron dome ø 200 mm	10087	1	
Front variants:			
Mounting frame, black 60 mm	 SET213314		6064,00
Additional option for cast iron dome			
Cast iron dome ø 180 mm	D004186		0,00



+ Cast iron dome ø 200 mm and cast iron heat exchanger rings	R015006-04	1	
Front variants:			
Mounting frame, black 60 mm	 SET213315		7005,50



+ Modular accumulator MAS 440 double-layered	R009042	5	
Cast iron cover MAS ø 180	R009095-01	1	
Mounting ring	10077	1	
Front variants:			
Mounting frame, black 60 mm	 SET213316		7457,50
Additional option MAS			
Exchange connecting piece ø 200 mm	R009105		58,00
Exchange connecting piece ø 160 mm	07137		58,00

Energy efficiency index A +



BKH 5.0 Eck 50-82-42 STL

Set consists of:	Art. No.	No.	Price
BKH 5.0 Eck 50-82-42 STL GK FR,		1	
Mounting frame 60 mm		1	
Chamotte inner lining (FR)		1	

Additional options (for all smoke hood variants)			
EAS (see page11)			1561,50
Reduced price for EAS without display			-148,00
ceramic glass coated (GKB)			150,00
Cast iron inner lining (FR/Guss)			330,00
Catalyst module BKH 5.0	HK000210		871,00
Supply air connection box ø 125 mm included at EAS version	HK000135		170,50
Supply air connection box ø 150 mm	HK000136		188,50

Smoke hood variants:



+ Cast iron dome ø 200 mm	10087	1	
Front variants:			
Mounting frame, black 60 mm		SET213317	5969,00
Additional option for cast iron dome			
Cast iron dome ø 180 mm	D004186		0,00



+ Cast iron dome ø 200 mm and cast iron heat exchanger rings	R015006-04	1	
Front variants:			
Mounting frame, black 60 mm		SET213318	6910,50



+ Modular accumulator MAS 440 double-layered	R009042	5	
Cast iron cover MAS ø 180	R009095-01	1	
Mounting ring	10077	1	
Front variants:			
Mounting frame, black 60 mm		SET213319	7362,50
Additional option MAS			
Exchange connecting piece ø 200 mm	R009105		58,00
Exchange connecting piece ø 160 mm	07137		58,00

Energy efficiency index A +

BKH 5.0 Eck 50-82-42 STR



Set consists of:	Art. No.	No.	Price
BKH 5.0 Eck 50-82-42 STR GK FR,		1	
Mounting frame 60 mm		1	
Chamotte inner lining (FR)		1	

Additional options (for all smoke hood variants)			
EAS (see page11)			1561,50
Reduced price for EAS without display			-148,00
ceramic glass coated (GKB)			150,00
Cast iron inner lining (FR/Guss)			330,00
Catalyst module BKH 5.0	HK000210		871,00
Supply air connection box ø 125 mm included at EAS version	HK000135		170,50
Supply air connection box ø 150 mm	HK00036		188,50

Smoke hood variants:



+ Cast iron dome ø 200 mm	10087	1	
Front variants:			
Mounting frame, black 60 mm		SET213320	5969,00
Additional option for cast iron dome			
Cast iron dome ø 180 mm	D004186		0,00



+ Cast iron dome ø 200 mm and cast iron heat exchanger rings	R015006-04	1	
Front variants:			
Mounting frame, black 60 mm		SET213321	6910,50



+ Modular accumulator MAS 440 double-layered	R009042	5	
Cast iron cover MAS ø 180	R009095-01	1	
Mounting ring	10077	1	
Front variants:			
Mounting frame, black 60 mm		SET213322	7362,50
Additional option MAS			
Exchange connecting piece ø 200 mm	R009105		58,00
Exchange connecting piece ø 160 mm	07137		58,00

Energy efficiency index A +



Eck-Kamin 42/42/42 side-opening door

Set consists of:	Art. No.	No.	Price
Eck-Kamin 42/42/42 side-opening door, two-piece ceramic glass		1	
Door frame		1	
Chamotte lining set, Eck-Kamin 42/42/42		1	

Additional options (for all smoke hood variants)			
EAS (see page 11)			1561,50
Reduced price for EAS without display			-148,00
Chamotte lining, anthracite	I064043-02		210,00

Smoke hood variants:



Cast iron hot air hood ø 200 mm	R014022-01	1	
Front variants:			
Door frame, black	 SET210472		3643,00
Additional option for cast iron hot air hood			
Cast iron hot air hood ø 250 mm	R014022-02		0,00
Cast iron hot air hood ø 180 mm	R014022-03		0,00



+ Cast iron dome ø 200 mm	10087	1	
Front variants:			
Door frame, black	 SET210474		3474,00
Additional option for cast iron dome			
Cast iron dome ø 180 mm	D004186		0,00



+ Modular accumulator MAS 440 double-layered	R009042	5	
Cast iron cover MAS ø 180	R009095-01	1	
Mounting ring	10077	1	
Front variants:			
Door frame, black	 SET210476		4867,50
Additional option MAS			
Exchange connecting piece ø 200 mm	R009105		58,00
Exchange connecting piece ø 160 mm	07137		58,00

Energy efficiency index A +

Eck-Kamin 51/52/52 side-opening door



Set consists of:	Art. No.	No.	Price
Eck-Kamin 51/52/52 side-opening door, two-piece ceramic glass		1	
Door frame		1	
Chamotte lining set, bright, for Eck-Kamin 51/52/52 u. 57/52/52		1	

Additional options (for all smoke hood variants)			
EAS (see page 11)			1561,50
EAS at DHT			1706,50
Reduced price for EAS without display			-148,00
Revision handle	02426		130,00
Chamotte lining, anthracite	40986-02		210,00

Additional charging door	
left side	right side
1030,00	1030,00

Smoke hood variants:



Cast iron hot air hood ø 200 mm	R014022-01	1	
Front variants:			
Door frame, black	SET210370		4007,50
Additional option for cast iron hot air hood			
Cast iron hot air hood ø 250 mm	R014022-02		0,00
Cast iron hot air hood ø 180 mm	R014022-03		0,00



+ Cast iron dome ø 200 mm	10087	1	
Front variants:			
Door frame, black	SET209986		3838,50
Additional option for cast iron dome			
Cast iron dome ø 180 mm	D004186		0,00



+ Modular accumulator MAS 440 double-layered	R009042	5	
Cast iron cover MAS ø 180	R009095-01	1	
Mounting ring	10077	1	
Front variants:			
Door frame, black	SET209988		5232,00
Additional option MAS			
Exchange connecting piece ø 200 mm	R009105		58,00
Exchange connecting piece ø 160 mm	07137		58,00

Energy efficiency class A



Eck-Kamin 51/52/52 lifting door



Set consists of:	Art. No.	No.	Price
Eck-Kamin 51/52/52 lifting door, two-piece ceramic glass		1	
Mounting frame		1	
Chamotte lining set, bright, for Eck-Kamin 51/52/52 u. 57/52/52		1	

Additional options (for all smoke hood variants)



EAS (see page 11)			1561,50
Reduced price for EAS without display			-148,00
Counterweights for non-self closing door	49097		46,50
Chamotte lining, anthracite	40986-02		210,00

Smoke hood variants:





Cast iron hot air hood ø 200 mm	R014022-01	1	
Front variants:			
Mounting frame, black, 50 mm	 SET210372		4949,50
Mounting frame, black, 70 mm	 SET210374		5085,50
Additional option for cast iron hot air hood			
Cast iron hot air hood ø 250 mm	R014022-02		0,00
Cast iron hot air hood ø 180 mm	R014022-03		0,00



+ Cast iron dome ø 200 mm	10087	1	
Front variants:			
Mounting frame, black, 50 mm	 SET209994		4780,50
Mounting frame, black, 70 mm	 SET209996		4916,50
Additional option for cast iron dome			
Cast iron dome ø 180 mm	D004186		0,00



+ Modular accumulator MAS 440 double-layered	R009042	5	
Cast iron cover MAS ø 180	R009095-01	1	
Mounting ring	10077	1	
Front variants:			
Mounting frame, black, 50 mm	 SET209999		6174,00
Mounting frame, black, 70 mm	 SET210001		6310,00
Additional option MAS			
Exchange connecting piece ø 200 mm	R009105		58,00
Exchange connecting piece ø 160 mm	07137		58,00



Energy efficiency class A

Eck-Kamin 57/52/52 side-opening door



Set consists of:	Art. No.	No.	Price
Eck-Kamin 57/52/52 side-opening door, two-piece ceramic glass		1	
Door frame		1	
Chamotte lining set, bright, for Eck-Kamin 51/52/52 u. 57/52/52		1	

Additional options (for all smoke hood variants)			
EAS (see page 11)			1561,50
EAS at DHT			1706,50
Reduced price for EAS without display			-148,00
Revision handle	02426		130,00
Chamotte lining, anthracite	40986-02		210,00

Additional charging door	
left side	right side
	
1030,00	1030,00

Smoke hood variants:



Cast iron hot air hood ø 200 mm	R014022-01	1	
Front variants:			
Door frame, black	 SET210482		4144,00
Additional option for cast iron hot air hood			
Cast iron hot air hood ø 250 mm	R014022-02		0,00
Cast iron hot air hood ø 180 mm	R014022-03		0,00



+ Cast iron dome ø 200 mm	10087	1	
Front variants:			
Door frame, black	 SET209990		3975,00
Additional option for cast iron dome			
Cast iron dome ø 180 mm	D004186		0,00



+ Modular accumulator MAS 440 double-layered	R009042	5	
Cast iron cover MAS ø 180	R009095-01	1	
Mounting ring	10077	1	
Front variants:			
Door frame, black	 SET209992		5368,50
Additional option MAS			
Exchange connecting piece ø 200 mm	R009105		58,00
Exchange connecting piece ø 160 mm	07137		58,00

Energy efficiency class A



Eck-Kamin 57/52/52 lifting door



Set consists of:	Art. No.	No.	Price
Eck-Kamin 57/52/52 lifting door, two-piece ceramic glass		1	
Mounting frame		1	
Chamotte lining set, bright, for Eck-Kamin 51/52/52 u. 57/52/52		1	

Additional options (for all smoke hood variants)



EAS (see page 11)			1561,50
Reduced price for EAS without display			-148,00
Counterweights for non-self closing door	49097		46,50
Chamotte lining, anthracite	40986-02		210,00

Smoke hood variants:





Cast iron hot air hood ø 200 mm	R014022-01	1	
Front variants:			
Mounting frame, black, 50 mm	 SET210377		5131,50
Mounting frame, black, 70 mm	 SET210379		5267,50
Additional option for cast iron hot air hood			
Cast iron hot air hood ø 250 mm	R014022-02		0,00
Cast iron hot air hood ø 180 mm	R014022-03		0,00



+ Cast iron dome ø 200 mm	10087	1	
Front variants:			
Mounting frame, black, 50 mm	 SET210004		4962,50
Mounting frame, black, 70 mm	 SET210006		5098,50
Additional option for cast iron dome			
Cast iron dome ø 180 mm	D004186		0,00



+ Modular accumulator MAS 440 double-layered	R009042	5	
Cast iron cover MAS ø 180	R009095-01	1	
Mounting ring	10077	1	
Front variants:			
Mounting frame, black, 50 mm	 SET210009		6356,00
Mounting frame, black, 70 mm	 SET210011		6492,00
Additional option MAS			
Exchange connecting piece ø 200 mm	R009105		58,00
Exchange connecting piece ø 160 mm	07137		58,00

Energy efficiency class A

Eck-Kamin 45/82/48 left side lifting door



Set consists of:	Art. No.	No.	Price
Eck-Kamin 45/82/48 left side lifting door, two-piece ceramic glass		1	
Mounting frame		1	
Chamotte lining set, bright, for Eck-Kamin 45/82/48 left side		1	

Additional options (for all smoke hood variants)			
EAS (see page 11)			1561,50
Reduced price for EAS without display			-148,00
Counterweights for non-self closing door	49097		46,50
Chamotte lining, anthracite	I063038-02		210,00

Smoke hood variants:



Cast iron hot air hood ø 200 mm	R014022-01	1	
Front variants:			
Mounting frame, black, 50 mm	SET210457		6002,00
Mounting frame, black, 70 mm	SET210459		6138,50
Additional option for cast iron hot air hood			
Cast iron hot air hood ø 250 mm	R014022-02		0,00
Cast iron hot air hood ø 180 mm	R014022-03		0,00



+ Cast iron dome ø 200 mm	10087	1	
Front variants:			
Mounting frame, black, 50 mm	SET210448		5833,00
Mounting frame, black, 70 mm	SET210450		5969,50
Additional option for cast iron dome			
Cast iron dome ø 180 mm	D004186		0,00



+ Modular accumulator MAS 440 double-layered	R009042	5	
Cast iron cover MAS ø 180	R009095-01	1	
Mounting ring	10077	1	
Front variants:			
Mounting frame, black, 50 mm	SET210453		7226,50
Mounting frame, black, 70 mm	SET210462		7363,00
Additional option MAS			
Exchange connecting piece ø 200 mm	R009105		58,00
Exchange connecting piece ø 160 mm	07137		58,00

Energy efficiency class A



Eck-Kamin 45/82/48 right side lifting door

Set consists of:	Art. No.	No.	Price
Eck-Kamin 45/82/48 right side lifting door, two-piece ceramic glass		1	
Mounting frame		1	
Chamotte lining set, bright, for Eck-Kamin 45/82/48 right side		1	

Additional options (for all smoke hood variants)			
EAS (see page 11)			1561,50
Reduced price for EAS without display			-148,00
Counterweights for non-self closing door	49097		46,50
Chamotte lining, anthracite	I063019-02		210,00

Smoke hood variants:



Cast iron hot air hood ø 200 mm	R014022-01	1	
Front variants:			
Mounting frame, black, 50 mm	SET210433		6002,00
Mounting frame, black, 70 mm	SET210435		6138,50
Additional option for cast iron hot air hood			
Cast iron hot air hood ø 250 mm	R014022-02		0,00
Cast iron hot air hood ø 180 mm	R014022-03		0,00



+ Cast iron dome ø 200 mm	10087	1	
Front variants:			
Mounting frame, black, 50 mm	SET210423		5833,00
Mounting frame, black, 70 mm	SET210425		5969,50
Additional option for cast iron dome			
Cast iron dome ø 180 mm	D004186		0,00



+ Modular accumulator MAS 440 double-layered	R009042	5	
Cast iron cover MAS ø 180	R009095-01	1	
Mounting ring	10077	1	
Front variants:			
Mounting frame, black, 50 mm	SET210428		7226,50
Mounting frame, black, 70 mm	SET210430		7363,00
Additional option MAS			
Exchange connecting piece ø 200 mm	R009105		58,00
Exchange connecting piece ø 160 mm	07137		58,00

Energy efficiency class A

Eck-Kamin 57/82/48 left side lifting door



Set consists of:	Art. No.	No.	Price
Eck-Kamin 57/82/48 left side lifting door, two-piece ceramic glass		1	
Mounting frame		1	
Chamotte lining set, bright, for Eck-Kamin 57/82/48 left side		1	

Additional options (for all smoke hood variants)			
EAS (see page 11)			1561,50
Reduced price for EAS without display			-148,00
Counterweights for non-self closing door	49097		46,50
Chamotte lining, anthracite	I013710-02		210,00

Smoke hood variants:



Cast iron hot air hood ø 200 mm	R014022-01	1	
Front variants:			
Mounting frame, black, 50 mm	SET210392		6144,50
Mounting frame, black, 70 mm	SET210394		6280,50
Additional option for cast iron hot air hood			
Cast iron hot air hood ø 250 mm	R014022-02		0,00
Cast iron hot air hood ø 180 mm	R014022-03		0,00



+ Cast iron dome ø 200 mm	10087	1	
Front variants:			
Mounting frame, black, 50 mm	SET210034		5975,50
Mounting frame, black, 70 mm	SET210036		6111,50
Additional option for cast iron dome			
Cast iron dome ø 180 mm	D004186		0,00



+ Modular accumulator MAS 440 double-layered	R009042	5	
Cast iron cover MAS ø 180	R009095-01	1	
Mounting ring	10077	1	
Front variants:			
Mounting frame, black, 50 mm	SET210039		7369,00
Mounting frame, black, 70 mm	SET210041		7505,00
Additional option MAS			
Exchange connecting piece ø 200 mm	R009105		58,00
Exchange connecting piece ø 160 mm	07137		58,00

Energy efficiency class A





Eck-Kamin 57/82/48 right side lifting door

Set consists of:	Art. No.	No.	Price
Eck-Kamin 57/82/48 right side lifting door, two-piece ceramic glass		1	
Mounting frame		1	
Chamotte lining set, bright, for Eck-Kamin 57/82/48 right side		1	



Additional options (for all smoke hood variants)			
EAS (see page 11)			1561,50
Reduced price for EAS without display			-148,00
Counterweights for non-self closing door	49097		46,50
Chamotte lining, anthracite	I013707-02		210,00

Smoke hood variants:





Cast iron hot air hood ø 200 mm	R014022-01	1	
Front variants:			
Mounting frame, black, 50 mm	 SET210397		6144,50
Mounting frame, black, 70 mm	 SET210399		6280,50
Additional option for cast iron hot air hood			
Cast iron hot air hood ø 250 mm	R014022-02		0,00
Cast iron hot air hood ø 180 mm	R014022-03		0,00



+ Cast iron dome ø 200 mm	10087	1	
Front variants:			
Mounting frame, black, 50 mm	 SET210044		5975,50
Mounting frame, black, 70 mm	 SET210046		6111,50
Additional option for cast iron dome			
Cast iron dome ø 180 mm	D004186		0,00



+ Modular accumulator MAS 440 double-layered	R009042	5	
Cast iron cover MAS ø 180	R009095-01	1	
Mounting ring	10077	1	
Front variants:			
Mounting frame, black, 50 mm	 SET210049		7369,00
Mounting frame, black, 70 mm	 SET210051		7505,00
Additional option MAS			
Exchange connecting piece ø 200 mm	R009105		58,00
Exchange connecting piece ø 160 mm	07137		58,00

Energy efficiency class A

Eck-Kamin 45/67/44 left side lifting door



Set consists of:	Art. No.	No.	Price
Eck-Kamin 45/67/44 left side lifting door, two-piece ceramic glass		1	
Mounting frame		1	
Chamotte lining set, bright, for Eck-Kamin 45/67/44 left side		1	



Additional options (for all smoke hood variants)			
EAS (see page 11)			1561,50
Reduced price for EAS without display			-148,00
Counterweights for non-self closing door	49097		46,50
Chamotte lining, anthracite	I062062-02		210,00

Smoke hood variants:





Cast iron hot air hood ø 200 mm	R014022-01	1	
Front variants:			
Mounting frame, black, 50 mm	 SET210401		5457,00
Mounting frame, black, 70 mm	 SET210403		5592,50
Additional option for cast iron hot air hood			
Cast iron hot air hood ø 250 mm	R014022-02		0,00
Cast iron hot air hood ø 180 mm	R014022-03		0,00



+ Cast iron dome ø 200 mm	10087	1	
Front variants:			
Mounting frame, black, 50 mm	 SET210314		5288,00
Mounting frame, black, 70 mm	 SET210316		5423,50
Additional option for cast iron dome			
Cast iron dome ø 180 mm	D004186		0,00



+ Modular accumulator MAS 440 double-layered	R009042	5	
Cast iron cover MAS ø 180	R009095-01	1	
Mounting ring	10077	1	
Front variants:			
Mounting frame, black, 50 mm	 SET210319		6681,50
Mounting frame, black, 70 mm	 SET210321		6817,00
Additional option MAS			
Exchange connecting piece ø 200 mm	R009105		58,00
Exchange connecting piece ø 160 mm	07137		58,00

Energy efficiency class A



Eck-Kamin 45/67/44 right side lifting door

Set consists of:	Art. No.	No.	Price
Eck-Kamin 45/67/44 right side lifting door, two-piece ceramic glass		1	
Mounting frame		1	
Chamotte lining set, bright, for Eck-Kamin 45/67/44 right side		1	



Additional options (for all smoke hood variants)			
EAS (see page 11)			1561,50
Reduced price for EAS without display			-148,00
Counterweights for non-self closing door	49097		46,50
Chamotte lining, anthracite	I062033-02		210,00

Smoke hood variants:





Cast iron hot air hood ø 200 mm	R014022-01	1	
Front variants:			
Mounting frame, black, 50 mm	 SET210408		5457,00
Mounting frame, black, 70 mm	 SET210410		5592,50
Additional option for cast iron hot air hood			
Cast iron hot air hood ø 250 mm	R014022-02		0,00
Cast iron hot air hood ø 180 mm	R014022-03		0,00



+ Cast iron dome ø 200 mm	10087	1	
Front variants:			
Mounting frame, black, 50 mm	 SET210294		5288,00
Mounting frame, black, 70 mm	 SET210296		5423,50
Additional option for cast iron dome			
Cast iron dome ø 180 mm	D004186		0,00



+ Modular accumulator MAS 440 double-layered	R009042	5	
Cast iron cover MAS ø 180	R009095-01	1	
Mounting ring	10077	1	
Front variants:			
Mounting frame, black, 50 mm	 SET210299		6681,50
Mounting frame, black, 70 mm	 SET210301		6817,00
Additional option MAS			
Exchange connecting piece ø 200 mm	R009105		58,00
Exchange connecting piece ø 160 mm	07137		58,00

Energy efficiency class A

Eck-Kamin 57/67/44 left side lifting door



Set consists of:	Art. No.	No.	Price
Eck-Kamin 57/67/44 left side lifting door, two-piece ceramic glass		1	
Mounting frame		1	
Chamotte lining set, bright, for Eck-Kamin 57/67/44 left side		1	

Additional options (for all smoke hood variants)			
EAS (see page 11)			1561,50
Reduced price for EAS without display			-148,00
Counterweights for non-self closing door	49097		46,50
Chamotte lining, anthracite	I012341-02		210,00

Smoke hood variants:



Cast iron hot air hood ø 200 mm	R014022-01	1	
Front variants:			
Mounting frame, black, 50 mm	SET210382		5603,00
Mounting frame, black, 70 mm	SET210384		5739,00
Additional option for cast iron hot air hood			
Cast iron hot air hood ø 250 mm	R014022-02		0,00
Cast iron hot air hood ø 180 mm	R014022-03		0,00



+ Cast iron dome ø 200 mm	10087	1	
Front variants:			
Mounting frame, black, 50 mm	SET210014		5434,00
Mounting frame, black, 70 mm	SET210016		5570,00
Additional option for cast iron dome			
Cast iron dome ø 180 mm	D004186		0,00



+ Modular accumulator MAS 440 double-layered	R009042	5	
Cast iron cover MAS ø 180	R009095-01	1	
Mounting ring	10077	1	
Front variants:			
Mounting frame, black, 50 mm	SET210019		6827,50
Mounting frame, black, 70 mm	SET210021		6963,50
Additional option MAS			
Exchange connecting piece ø 200 mm	R009105		58,00
Exchange connecting piece ø 160 mm	07137		58,00

Energy efficiency class A



Eck-Kamin 57/67/44 right side lifting door



Set consists of:	Art. No.	No.	Price
Eck-Kamin 57/67/44 right side lifting door, two-piece ceramic glass		1	
Mounting frame		1	
Chamotte lining set, bright, for Eck-Kamin 57/67/44 right side		1	

Additional options (for all smoke hood variants)



EAS (see page 11)			1561,50
Reduced price for EAS without display			-148,00
Counterweights for non-self closing door	49097		46,50
Chamotte lining, anthracite	I012340-02		210,00

Smoke hood variants:





Cast iron hot air hood ø 200 mm	R014022-01	1	
Front variants:			
Mounting frame, black, 50 mm	 SET210387		5603,00
Mounting frame, black, 70 mm	 SET210389		5739,00
Additional option for cast iron hot air hood			
Cast iron hot air hood ø 250 mm	R014022-02		0,00
Cast iron hot air hood ø 180 mm	R014022-03		0,00



+ Cast iron dome ø 200 mm	10087	1	
Front variants:			
Mounting frame, black, 50 mm	 SET210024		5434,00
Mounting frame, black, 70 mm	 SET210026		5570,00
Additional option for cast iron dome			
Cast iron dome ø 180 mm	D004186		0,00



+ Modular accumulator MAS 440 double-layered	R009042	5	
Cast iron cover MAS ø 180	R009095-01	1	
Mounting ring	10077	1	
Front variants:			
Mounting frame, black, 50 mm	 SET210029		6827,50
Mounting frame, black, 70 mm	 SET210031		6963,50
Additional option MAS			
Exchange connecting piece ø 200 mm	R009105		58,00
Exchange connecting piece ø 160 mm	07137		58,00

Energy efficiency class A

Eck-Kamin 70/33/33 lifting door



Set consists of:	Art. No.	No.	Price
Eck-Kamin 70/33/33 lifting door , two-piece ceramic glass, outlet ø 180 mm		1	
Mounting frame		1	
Chamotte lining set, bright, for Eck-Kamin 70/33/33		1	

Additional options			
EAS (see page 11)			1561,50
Reduced price for EAS without display			-148,00
Counterweights for non-self closing door	49097		46,50
Chamotte lining, anthracite	I065068-02		210,00

Available variants:

Front variants:			
Mounting frame, black, 50 mm		SET210510	4914,00
Mounting frame, black, 70 mm		SET210512	5050,50

Energy efficiency index A +



Eck-Kamin 42/57/30 left side side-opening door

Set consists of:	Art. No.	No.	Price
Eck-Kamin 42/57/30 left side side-opening door, two-piece ceramic glass, outlet \varnothing 200 mm		1	
Door frame or mounting frame		1	
Chamotte lining set, bright, for Eck-Kamin 42/57/30		1	

Additional options			
EAS (see page 11)			1561,50
Reduced price for EAS without display			-148,00
Chamotte lining, anthracite	I068112-02		210,00
Exchange connecting piece \varnothing 180 mm	I058043		77,00
Exchange connecting piece \varnothing 160 mm	I058046		77,00

Available variants:

Front variants:			
Door frame, black		SET212679	4254,00
Mounting frame, black 50 mm		SET213036	4318,50

Energy efficiency index A +

Eck-Kamin 42/57/30 right side side-opening door

Set consists of:	Art. No.	No.	Price
Eck-Kamin 42/57/30 right side side-opening door, two-piece ceramic glass, outlet \varnothing 200 mm		1	
Door frame or mounting frame		1	
Chamotte lining set, bright, for Eck-Kamin 42/57/30		1	

Additional options			
EAS (see page 11)			1561,50
Reduced price for EAS without display			-148,00
Chamotte lining, anthracite	I068094-02		210,00
Exchange connecting piece \varnothing 180 mm	I058043		77,00
Exchange connecting piece \varnothing 160 mm	I058046		77,00

Available variants:

Front variants:			
Door frame, black		SET212677	4254,00
Mounting frame, black 50 mm		SET213037	4318,50

Energy efficiency index A +

Eck-Kamin 42/57/30 left side lifting door



Set consists of:	Art. No.	No.	Price
Eck-Kamin 42/57/30 left side, two-piece ceramic glass, outlet ø 200 mm		1	
Mounting frame		1	
Chamotte lining set, bright, for Eck-Kamin 42/57/30		1	

Additional options			
EAS (see page 11)			1561,50
Reduced price for EAS without display			-148,00
Chamotte lining, anthracite	I068112-02		210,00
Counterweights for non-self closing door	49097		46,50
Exchange connecting piece ø 180 mm	I058043		77,00
Exchange connecting piece ø 160 mm	I058046		77,00

Available variants:

Front variants:			
Mounting frame, black, 50 mm		SET212672	5206,50
Mounting frame, black, 70 mm		SET212674	5342,50

Energy efficiency index A +

Eck-Kamin 42/57/30 right side lifting door



Set consists of:	Art. No.	No.	Price
Eck-Kamin 42/57/30 right side, two-piece ceramic glass, outlet ø 200 mm		1	
Mounting frame		1	
Chamotte lining set, bright, for Eck-Kamin 42/57/30		1	

Additional options			
EAS (see page 11)			1561,50
Reduced price for EAS without display			-148,00
Chamotte lining, anthracite	I068094-02		210,00
Counterweights for non-self closing door	49097		46,50
Exchange connecting piece ø 180 mm	I058043		77,00
Exchange connecting piece ø 160 mm	I058046		77,00

Available variants:

Front variants:			
Mounting frame, black, 50 mm		SET212667	5206,50
Mounting frame, black, 70 mm		SET212669	5342,50

Energy efficiency index A +



Architektur-Kamin Eck 38/86/36 left side

Set consists of:	Art. No.	No.	Price
Architektur-Kamin Eck 38/86/36 left side, two-piece ceramic glass, outlet ø 200 mm		1	
Mounting frame		1	
Chamotte lining set, bright, for AK-corner 38/86/36		1	

Additional options			
EAS (see page 11)			1561,50
Reduced price for EAS without display			-148,00
Chamotte lining, anthracite	40959.1-02		210,00
Counterweights for non-self closing door	49097		46,50
Smoke pipe adapter for horizontal/vertical outlet	BSK7000-129		405,50
Exchange connecting piece ø 180 mm	I058043		77,00

Available variants:

Front variants:			
Mounting frame, black, 50 mm		SET205941	5700,50
Mounting frame, black, 70 mm		SET208777	5836,50

Energy efficiency class A



Architektur-Kamin Eck 38/86/36 right side

Set consists of:	Art. No.	No.	Price
Architektur-Kamin 38/86/36 right side, two-piece ceramic glass, outlet ø 200 mm		1	
Mounting frame		1	
Chamotte lining set, bright, for AK-corner 38/86/36		1	

Additional options			
EAS (see page 11)			1561,50
Reduced price for EAS without display			-148,00
Chamotte lining, anthracite	40959.1-02		210,00
Counterweights for non-self closing door	49097		46,50
Smoke pipe adapter for horizontal/vertical outlet	BSK7000-129		405,50
Exchange connecting piece ø 180 mm	I058043		77,00

Available variants:

Front variants:			
Mounting frame, black, 50 mm		SET205945	5700,50
Mounting frame, black, 70 mm		SET208779	5836,50

Energy efficiency class A

Architektur-Kamin 2T 45_101_40 links

Architektur-Kamin Eck 45/101/40, right side



Set consists of:	Art. No.	No.	Price
Architektur-Kamin 45/101/40, right side, two-piece ceramic glass, outlet ø 250 mm		1	
Mounting frame		1	
Chamotte lining set, bright, for AK-corner 45/101/40		1	

Additional options			
Chamotte lining, anthracite	I051069-2		210,00
Counterweights for non-self closing door	49097		46,50
Smoke pipe adapter for horizontal outlet	I019490		299,00
Exchange connecting piece ø 200 mm	I019449		61,00

Available variants:

Front variants:			
Mounting frame, black, 50 mm		SET207160	7513,50
Mounting frame, black, 70 mm		SET208781	7649,50

Energy efficiency class A





Architektur-Kamin Eck 53/121/50 left side

Set consists of:	Art. No.	No.	Price
Architektur-Kamin 53/121/50 left side, two-piece ceramic glass, outlet ø 250 mm		1	
Mounting frame		1	
Chamotte lining set, bright, for AK-corner 53/121/50		1	

Additional options			
Chamotte lining, anthracite	I008362-02		210,00
Counterweights for non-self closing door	49097		46,50
Smoke pipe adapter for horizontal outlet	I019490		299,00
Exchange connecting piece ø 200 mm	I019449		61,00

Available variants:

Front variants:			
Mounting frame, black, 50 mm		SET205949	8415,50
Mounting frame, black, 70 mm		SET208782	8551,50

Energy efficiency class A



Architektur-Kamin Eck 53/121/50 right side

Set consists of:	Art. No.	No.	Price
Architektur-Kamin 53/121/50 right side, two-piece ceramic glass, outlet ø 250 mm		1	
Mounting frame		1	
Chamotte lining set, bright, for AK-corner 53/121/50		1	

Additional options			
Chamotte lining, anthracite	I008324-02		210,00
Counterweights for non-self closing door	49097		46,50
Smoke pipe adapter for horizontal outlet	I019490		299,00
Exchange connecting piece ø 200 mm	I019449		61,00

Available variants:

Front variants:			
Mounting frame, black, 50 mm		SET205953	8415,50
Mounting frame, black, 70 mm		SET208783	8551,50

Energy efficiency class A

flat

Tunnel

Eck

Panorama



Panorama-Kamin 42/42/42/42

Set consists of:	Art. No.	No.	Price
Panorama-Kamin 42/42/42/42, outlet ø 200 mm		1	
Chamotte lining set Panorama-Kamin 42/42/42/42		1	

Additional options			
EAS (see page 11)			1561,50
Reduced price for EAS without display			-148,00
Counterweights for non-self closing door	49097		46,50
Exchange connecting piece ø 180 mm	I058043		77,00
Chamotte lining, anthracite	I067002-02		210,00
Turnbuckle for suspending of support elements (per insert 2 pieces required)	O2567		15,50

Available variants:

Front variants:			
Panorama frame, narrow, black		SET210478	6330,50
Panorama frame, wide, black		SET210480	6330,50

Energy efficiency class A

Panorama-Kamin 51/50/50/50





Set consists of:	Art. No.	No.	Price
Panorama-Kamin 51/50/50/50 , outlet ø 200 mm		1	
Combustion chamber lining Panorama-Kamin 51/50/50/50		1	

Additional options			
EAS (see page 11)			1561,50
Reduced price for EAS without display			-148,00
Counterweights for non-self closing door	included/modification		
Combustion chamber lining black 51/50/50/50	I072006-02		210,00
Catalytic converter Panorama-Kamin	I072078		725,50
Carrier unit suspended 51/50/50/50	I072083		722,50

Available variants:

Front variants:			
Panorama frame, narrow, black		SET213092	7385,50
Panorama frame, wide, black		SET213093	7385,50
Additional options			
Exchange connecting piece ø 180 mm	I058043		77,00



+ Modular accumulator MAS 440 double-layered	R009042	3	
Cast iron dome MAS ø 200	R009095-02	1	
Mounting ring	10085.1	1	
Front variants:			
Panorama frame, narrow, black		SET213094	8621,50
Panorama frame, wide, black		SET213095	8621,50

Energy efficiency index A +



Panorama-Kamin 51/66/40/66

Set consists of:	Art. No.	No.	Price
Panorama-Kamin 51/66/40/66, outlet ø 200 mm		1	
Combustion chamber lining Panorama-Kamin 51/66/40/66		1	

Additional options			
EAS (see page 11)			1561,50
Reduced price for EAS without display			-148,00
Counterweights for non-self closing door	included/modification		
Exchange connecting piece ø 180 mm	I058043		77,00
Combustion chamber lining black	I071009-02		210,00
Carrier unit suspended 51/66/40/66	I071079		747,50

Available variants:

Front variants:			
Panorama frame, narrow, black		SET213100	7783,50
Panorama frame, wide, black		SET213101	7783,50

Energy efficiency index A +

Panorama-Kamin 51/66/50/66



Set consists of:	Art. No.	No.	Price
Panorama-Kamin 51/66/50/66, outlet ø 200 mm		1	
Combustion chamber lining Panorama-Kamin 51/66/50/66		1	

Additional options			
EAS (see page 11)			1561,50
Reduced price for EAS without display			-148,00
Counterweights for non-self closing door		included/modification	
Exchange connecting piece ø 180 mm	I019448		61,00
Exchange connecting piece ø 250 mm	I019450		61,00
Combustion chamber lining black	I047130-02		210,00
Carrier unit suspended 51/66/50/66	I047172		772,00

Available variants:

Front variants:			
Panorama frame, narrow, black		SET213102	8242,00
Panorama frame, wide, black		SET213103	8242,00

Energy efficiency index A +

Panorama-Kamin 51/88/50/88



Set consists of:	Art. No.	No.	Price
Panorama-Kamin 51/88/50/88, outlet ø 200 mm		1	
Combustion chamber lining Panorama-Kamin 51/88/50/88		1	

Additional options			
EAS (see page 11)			1561,50
Reduced price for EAS without display			-148,00
Counterweights for non-self closing door		included/modification	
Exchange connecting piece ø 180 mm	I019448		61,00
Exchange connecting piece ø 250 mm	I019450		61,00
Combustion chamber lining black	I048180-02		210,00
Carrier unit suspended 51/88/50/88	I048212		822,50

Available variants:

Front variants:			
Panorama frame, narrow, black		SET213104	8799,50
Panorama frame, wide, black		SET213105	8799,50

Energy efficiency index A +



Panorama-Kamin 70/25/40/25

Set consists of:	Art. No.	No.	Price
Panorama-Kamin 70/25/40/25 , outlet ø 200 mm		1	
Chamotte lining set Panorama-Kamin 70/25/40/25		1	

Additional options			
EAS (see page 11)			1561,50
Reduced price for EAS without display			-148,00
Counterweights for non-self closing door	49097		46,50
Exchange connecting piece ø 180 mm	I058043		77,00
Chamotte lining, anthracite	I066002-02		210,00
Turnbuckle for suspending of support elements (per insert 2 pieces required)	O2567		15,50

Available variants:

Front variants:			
Panorama frame, narrow, black		SET210464	6855,00
Panorama frame, wide, black		SET210466	6855,00

Energy efficiency index A +

Panorama-Kamin 57/25/60/25



Set consists of:	Art. No.	No.	Price
Panorama-Kamin 57/25/60/25 , outlet ø 200 mm		1	
Chamotte lining set Panorama-Kamin 57/25/60/25		1	

Additional options			
EAS (see page 11)			1561,50
Reduced price for EAS without display			-148,00
Counterweights for non-self closing door	49097		46,50
Exchange connecting piece ø 180 mm	I019448		61,00
Exchange connecting piece ø 250 mm	I019450		61,00
Connection adapter ø 160 mm for changing the combustion air supply from side to rear	BSK5000-130		116,00
Chamotte lining, anthracite	I053034-02		210,00
Smoke pipe adapter for horizontal/vertical outlet inclusive spare connecting piece	I009168		429,00
Turnbuckle for suspending of support elements (per insert 2 pieces required)	O2567		15,50

Available variants:

Front variants:			
Panorama frame, narrow, black		SET207123	6775,50
Panorama frame, wide, black		SET207125	6775,50

Energy efficiency index A +

Panorama-Kamin 57/40/60/40



Set consists of:	Art. No.	No.	Price
Panorama-Kamin 57/40/60/40, outlet ø 200 mm		1	
Chamotte lining set Panorama-Kamin 57/40/60/40		1	

Additional options			
EAS (see page 11)			1561,50
Reduced price for EAS without display			-148,00
Counterweights for non-self closing door	49097		46,50
Exchange connecting piece ø 180 mm	I019448		61,00
Exchange connecting piece ø 250 mm	I019450		61,00
Connection adapter ø 160 mm for changing the combustion air supply from side to rear	BSK5000-130		116,00
Chamotte lining, anthracite	I007312-02		210,00
Smoke pipe adapter for horizontal/vertical outlet inclusive spare connecting piece	I009168		429,00
Turnbuckle for suspending of support elements (per insert 2 pieces required)	02567		15,50

Available variants:

Front variants:			
Panorama frame, narrow, black		SET205987	6962,50
Panorama frame, wide, black		SET205989	6962,50

Energy efficiency class A



Panorama-Kamin 57/25/85/25

Set consists of:	Art. No.	No.	Price
Panorama-Kamin 57/25/85/25, outlet ø 200 mm		1	
Chamotte lining set Panorama-Kamin 57/25/85/25		1	

Additional options			
EAS (see page 11)			1561,50
Reduced price for EAS without display			-148,00
Counterweights for non-self closing door	49097		46,50
Exchange connecting piece ø 180 mm	I019448		61,00
Exchange connecting piece ø 250 mm	I019450		61,00
Connection adapter ø 160 mm for changing the combustion air supply from side to rear	BSK5000-130		116,00
Chamotte lining, anthracite	I050073-02		210,00
Smoke pipe adapter for horizontal/vertical outlet inclusive spare connecting piece	I009168		429,00
Turnbuckle for suspending of support elements (per insert 2 pieces required)	02567		15,50

Available variants:

Available variants:			
Panorama frame, narrow, black		SET206983	7578,00
Panorama frame, wide, black		SET206985	7578,00

Energy efficiency index A +

Panorama-Kamin 57/40/85/40



Set consists of:	Art. No.	No.	Price
Panorama-Kamin 57/40/85/40, outlet ø 200 mm		1	
Chamotte lining set Panorama-Kamin 57/40/85/40		1	

Additional options			
EAS (see page 11)			1561,50
Reduced price for EAS without display			-148,00
Counterweights for non-self closing door	49097		46,50
Exchange connecting piece ø 180 mm	I019448		61,00
Exchange connecting piece ø 250 mm	I019450		61,00
Connection adapter ø 160 mm for changing the combustion air supply from side to rear	BSK5000-130		116,00
Chamotte lining, anthracite	I009149-02		210,00
Smoke pipe adapter for horizontal/vertical outlet inclusive spare connecting piece	I009168		429,00
Turnbuckle for suspending of support elements (per insert 2 pieces required)	02567		15,50

Available variants:

Available variants:			
Panorama frame, narrow, black		SET205991	7850,50
Panorama frame, wide, black		SET205993	7850,50

Energy efficiency index A +



Panorama-Kamin 51/25/101/25

Set consists of:	Art. No.	No.	Price
Panorama-Kamin 51/25/101/25, outlet ø 200 mm		1	
Chamotte lining set Panorama-Kamin 51/25/101/25		1	

Additional options			
EAS (see page 11)			1561,50
Reduced price for EAS without display			-148,00
Counterweights for non-self closing door	49097		46,50
Exchange connecting piece ø 180 mm	I019448		61,00
Exchange connecting piece ø 250 mm	I019450		61,00
Connection adapter ø 160 mm for changing the combustion air supply from side to rear	BSK5000-130		116,00
Chamotte lining, anthracite	I054088-02		210,00
Smoke pipe adapter for horizontal/vertical outlet inclusive spare connecting piece	I009168		429,00
Turnbuckle for suspending of support elements (per insert 2 pieces required)	02567		15,50

Available variants:

Available variants:			
Panorama frame, narrow, black		SET209336	8792,50
Panorama frame, wide, black		SET209338	8792,50

Energy efficiency class A

Panorama-Kamin 57/25/121/25



Set consists of:	Art. No.	No.	Price
Panorama-Kamin 57/25/121/25, outlet ø 200 mm		1	
Chamotte lining set Panorama-Kamin 57/25/121/25		1	

Additional options			
EAS (see page 11)			1561,50
Reduced price for EAS without display			-148,00
Counterweights for non-self closing door	49097		46,50
Exchange connecting piece ø 180 mm	I019448		61,00
Exchange connecting piece ø 250 mm	I019450		61,00
Connection adapter ø 160 mm for changing the combustion air supply from side to rear	BSK5000-130		116,00
Chamotte lining, anthracite	I055066-02		210,00
Smoke pipe adapter for horizontal/vertical outlet inclusive spare connecting piece	I009168		429,00
Turnbuckle for suspending of support elements (per insert 2 pieces required)	02567		15,50

Available variants:

Available variants:			
Panorama frame, narrow, black		SET209340	9759,50
Panorama frame, wide, black		SET209342	9759,50

Energy efficiency class A



Panorama-Kamin s-fire 42/42/66/42

Set consists of:	Art. No.	No.	Price
Panorama-Kamin s-fire 42/42/66/42 , outlet ø 200 mm		1	
Combustion chamber lining black Panorama-Kamin 42/42/66/42		1	
Counterweights for non-self closing door		1	

Additional options

Exchange connecting piece ø 180 mm	I058043		77,00
Exchange connecting piece ø 150 mm	I070092		77,00
Turnbuckle for suspending of support elements (per insert 2 pieces required)	02567		15,50

Available variants:

Front variants:			
Panorama frame, wide, black		I070001-01	6636,50
Panorama frame, wide, stainless steel		I070001-02	6983,00

flat

Tunnel

Eck

Panorama

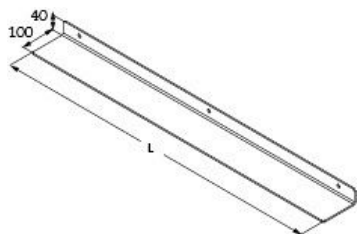

Accessories

Support frame

Article description	Art. No.	Retail price
Mounting bracket flat KK Standard flat side-opening/lifting doors	49099	145,50

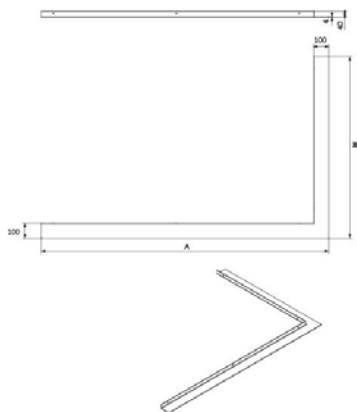

Article description	Art. No.	Retail price
Mounting brackets Eck-Kamin + Architektur-corners		
xx/52/52 lifting door/side opening door	49150	243,00
57/67/44 r/l	49152	271,50
57/82/48 r/l	49152	271,50
Architektur-Eck left side 53/121/50 + 45/101/40	49157	335,50
Architektur-Eck right side 53/121/50 + 45/101/40	49158	335,50

Article description	Art. No.	Retail price
Flexible hose		
ø 125 mm for external air connection	49202	71,50
ø 160 mm for external air connection	49203	87,00



Article description	Art. No.	Retail price
Damper flaps		
Damper flap ø 180 mm	02459	135,50
Damper flap ø 200 mm	02460	147,50
Damper flap ø 250 mm	02461	158,00
Damper flap ø 300 mm	02462	175,00



Article description	Art. No.	Retail price
Modern style handle for damper flaps / smoke valves, with shaft	10275	145,00
Recessed handle for damper flaps / smoke valves, with shaft	900296	165,50
Bediengriff rustikal for damper flaps / smoke valves, with shaft	10274	133,00



Recessed handle

Sissi flap

(suitable for Eck 53/121/50, Tunnel 53/121, Tunnel 53/135, Tunnel 53/166 and the Panorama variants except Panorama 42/42/42/42, 70/25/40/25 und 51/66/40/66)

Article description	Art. No.	Retail price
Sissi flap* for smoke pipe ∅ 180 mm	209300K	489,50
Sissi flap* for smoke pipe ∅ 200 mm	209301K	515,00
Sissi flap* for smoke pipe ∅ 250 mm	209302k	553,00

Sissi flap

(suitable for all other fireplaces with connecting piece dia. = 125 mm)

Article description	Art. No.	Retail price
Sissi flap* for smoke pipe ∅ 180 mm	209300KA	589,50
Sissi flap* for smoke pipe ∅ 200 mm	209301KA	615,50
Sissi flap* for smoke pipe ∅ 250 mm	209302KA	652,00

* consists of additional air supply Z130, fixtures for additional air supply assembly (in D = 180 mm, D = 200 mm or D = 250mm), T-piece (in D = 180 mm, D = 200 mm or D = 250 mm), adjustable clamps 150-170 (2 pcs.), adapter 160/125 mm (only for fireplaces with combustion air supply connection D = 125 mm; Art. No. 209300KA, 209301KA or 209302KA)

For all aforementioned variants, the stainless steel pipe must be ordered separately, specifying the required length.

Article description	Art. No.	Retail price
Round stainless steel hose dia. = 160 mm (according to DIN 4102-A1) for Sissi flap/by metre	900094	43,50

Schematic drawing

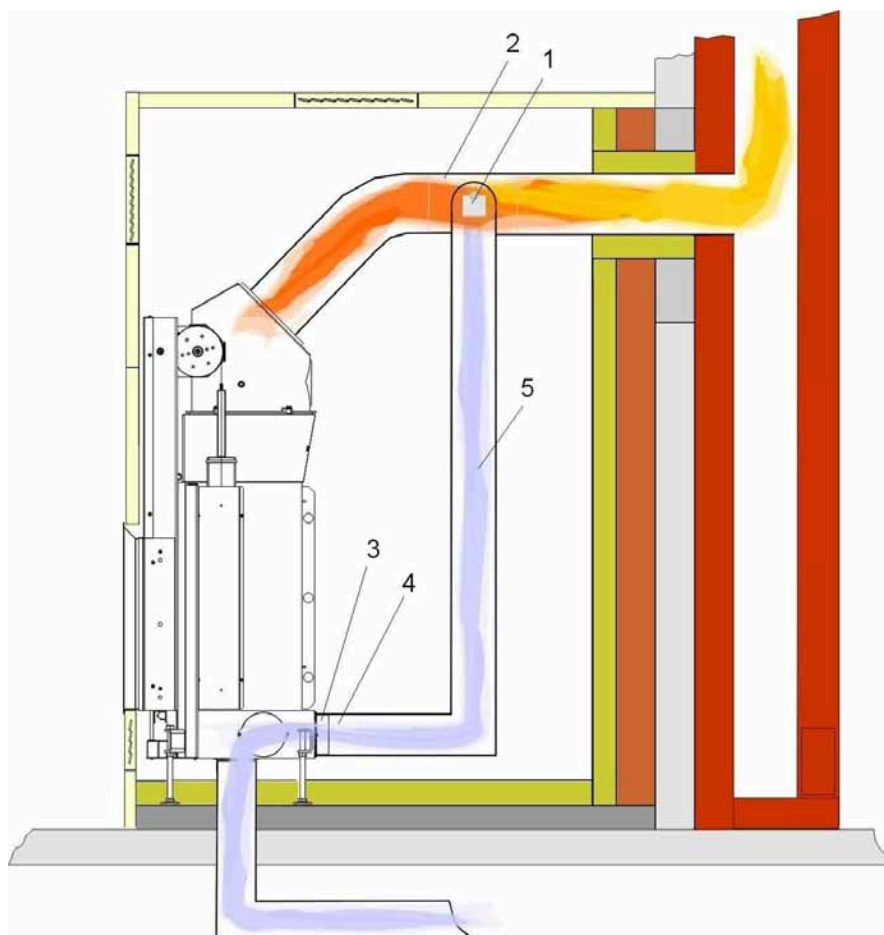

- 1 Supplementary air supply with assembly kit and adjustable clamp
- 2 T-piece
- 3 Combustion air connection \varnothing 125 mm or \varnothing 160 mm with clamp
- 4 Adapter 160/125
- 5 Round stainless steel hose \varnothing 160 mm

The Formats

flat

from
page
88



Urfeuer- open fireplace
50/66
Urfeuer-Kitchen- Fireplace®
50/66



Urfeuer- open fireplace
50/88



Urfeuer- open fireplace
50/110

Door dimensions height x width in cm

Eck corners

from
page
92



Urfeuer- open fireplace
Eck
50/88/44

Door dimensions height x width x width in cm

Panorama formats

from
page
94



Urfeuer- open fireplace
Panorama
50/44/66/44



Urfeuer- open fireplace Panorama
50/44/88/44

Door dimensions height x side width x front width x side width in cm

4free



Urfeuer- open fireplace
4free70

from
page
96

Variants for firing chamber extension

Urfeuer flach

mit Anbaurahmen für Feuerraumfortführung (beige) und modularem Aufbau der Feuerraumfortführung L/R (rot/rosa)

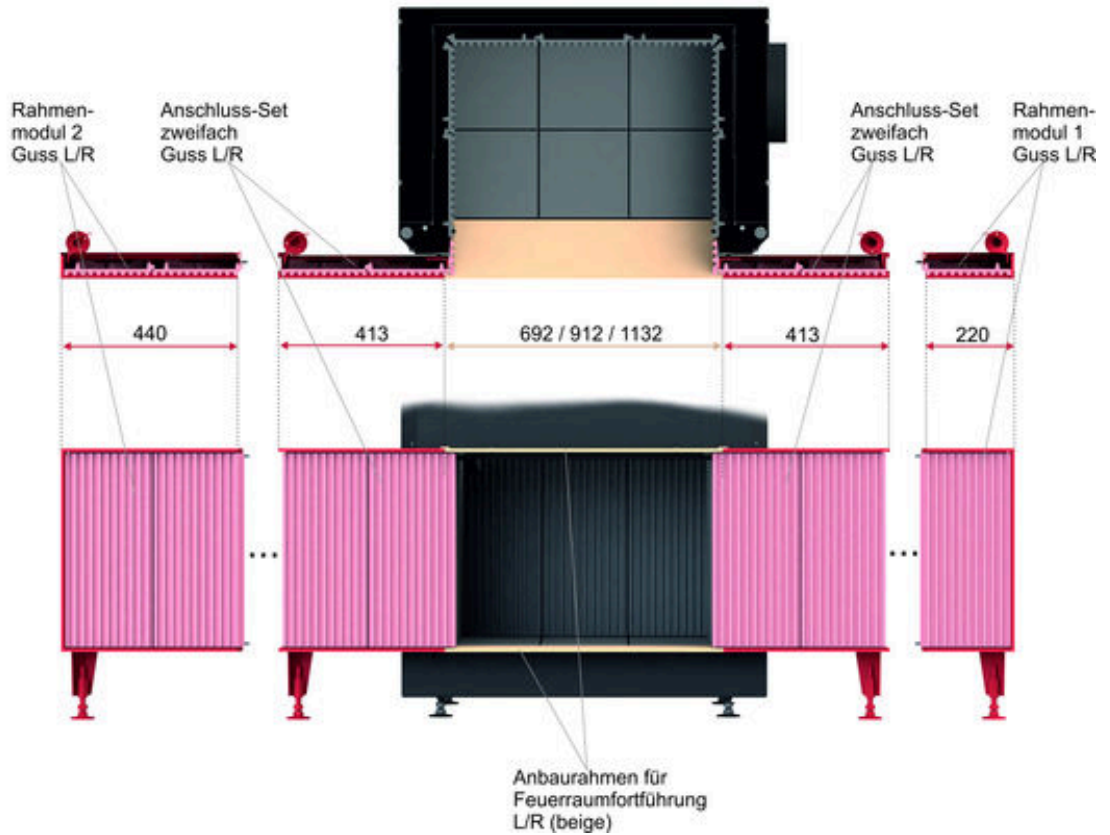

Urfeuer Eck

mit Anbaurahmen für Feuerraumfortführung (beige) und modularem Aufbau der Feuerraumfortführung L/R unter 0° und 90° (rot/rosa)

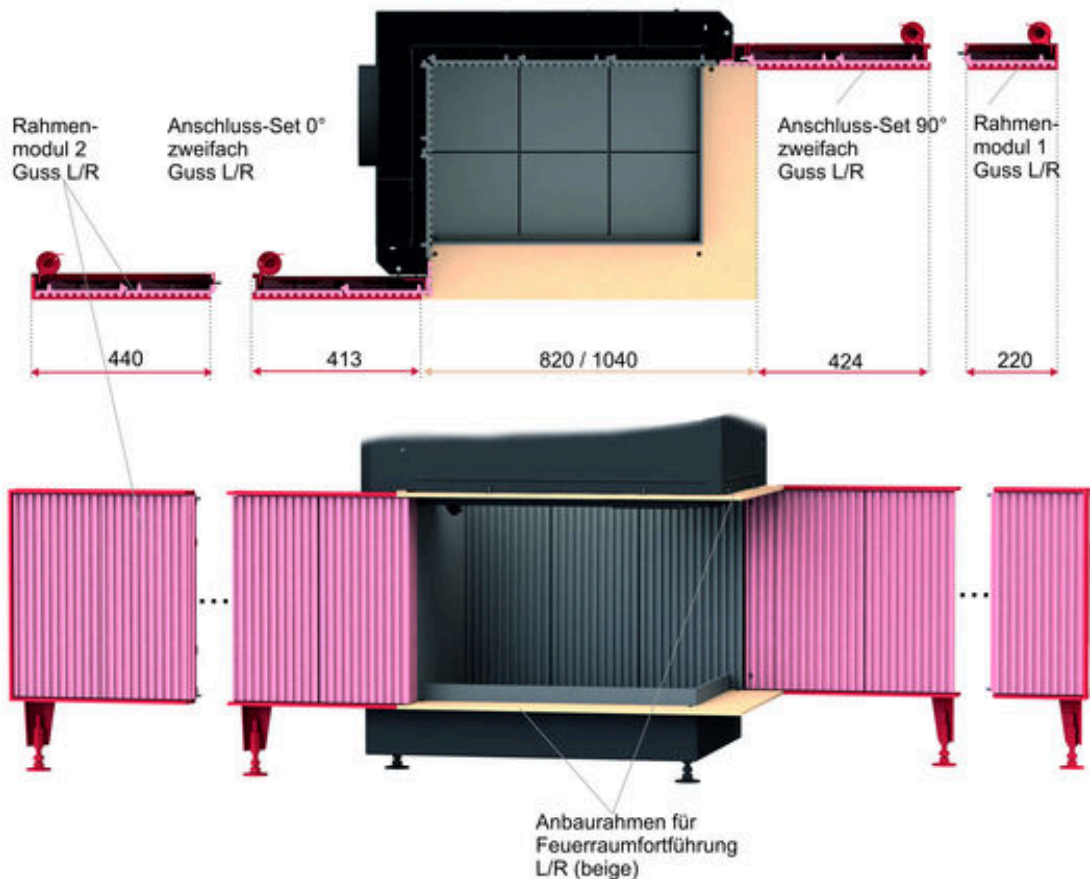

Urfeuer Panorama

mit Anbaurahmen für Feuerraumfortführung (beige) und modularem Aufbau der Feuerraumfortführung L/R unter 0° und 90° (rot/rosa)

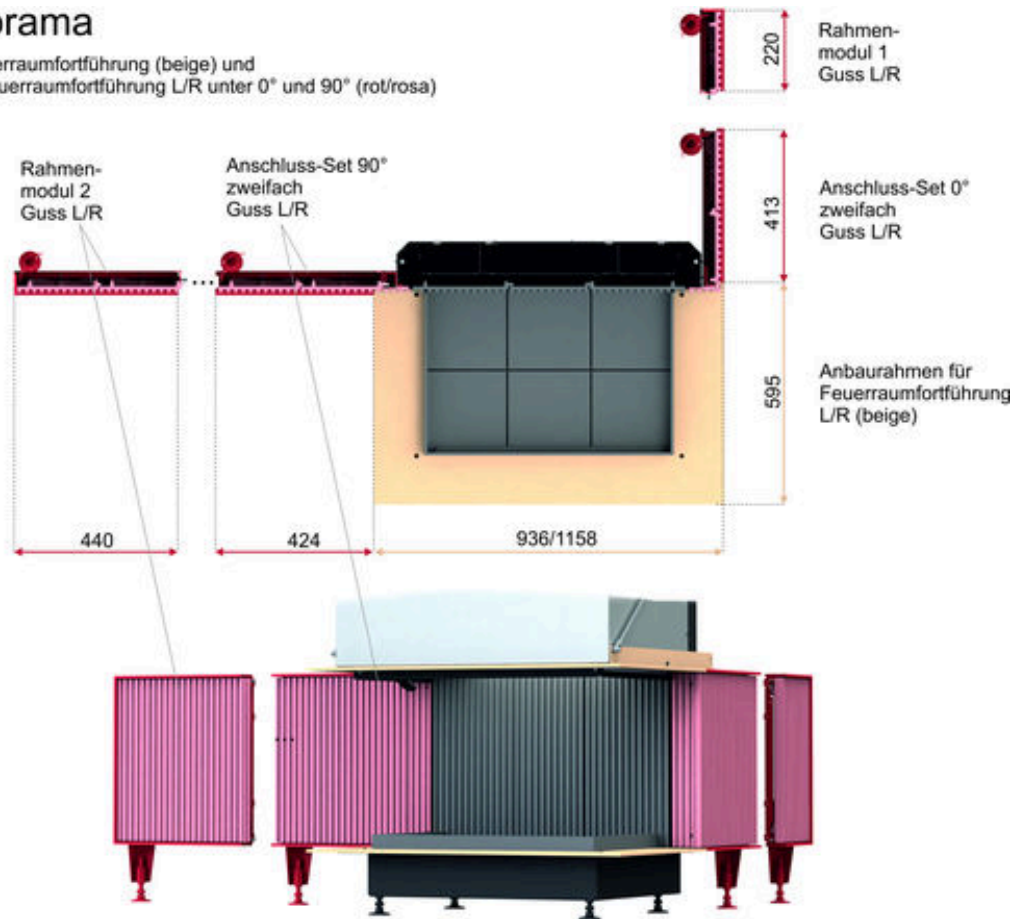



Urfeuer- open fireplace 50/66

Set consists of:	Art. No.	No.	Price
Urfeuer- open fireplace 50/66 outlet ø 300 mm		1	
Mounting frame		1	
Combustion chamber inner lining made of cast iron		1	

Additional options			
Spare connecting piece ø 250 mm	D015042		105,00

Available variants:

Front variants:			
Mounting frame, black, 60 mm		SET212690	6587,00
Mounting bracket, black for natural stone		SET212691	6587,00
Mounting frame, black, 60 mm L/R 2		SET212693	7426,00
Mounting frame, black, 60 mm L2/ R2		SET212695	8142,50

Options for the extension of the firing chamber			
Frame module 1 piece	D020006-01		543,50
Frame module double	D021006-01		643,00

Overview of firing chamber extension (see page 86)
Accessories (see page 98)

Energy efficiency index F





Urfeuer-Kitchen- Fireplace® 50/66



Set consists of:	Art. No.	No.	Price
Urfeuer-Kitchen- Fireplace® 50/66 outlet ø 300 mm		1	
Mounting frame		1	
Combustion chamber inner lining made of cast iron		1	
Interior lighting combustion chamber		1	
Grill support with new grill grate made of cast iron		1	

Additional options			
Knifeblock set consisting of: Knife block Meat fork 2 x Cooking knife 1 x Utility knife 1 x	SET212773		635,00
Grill drip tray	N006062		222,00
Double-enamelled cast iron oven-pan	K011151		135,00
Spare connecting piece ø 250 mm	D015042		105,00

Available variants:

Front variants:			
Mounting frame, black, 60 mm		SET212722	9613,00
Mounting bracket, black, for natural stone		SET212723	9613,00
Mounting frame, black, 60 mm L/R 2		SET212724	10452,00
Mounting frame, black, 60 mm L2/ R2		SET212726	11168,50
Functional niche black for kitchen-fireplace Urfeuer		SET212932	10313,50

Options for the extension of the firing chamber			
Frame module 1 piece	D020006-01		543,50
Frame module double	D021006-01		643,00

Overview of firing chamber extension (see page 86)
Accessories (see page 98)

Energy efficiency index F



Urfeuer- open fireplace 50/88

Set consists of:	Art. No.	No.	Price
Urfeuer- open fireplace 50/88 outlet ø 300 mm		1	
Mounting frame		1	
Combustion chamber inner lining made of cast iron		1	

Available variants:

Front variants:			
Mounting frame, black, 60 mm		SET212685	6997,50
Mounting frame, black, 60 mm L/R 2		SET212686	7845,00
Mounting frame, black, 60 mm L2/ R2		SET212688	8561,50

Options for the extension of the firing chamber			
Frame module 1 piece	D020006-01		543,50
Frame module double	D021006-01		643,00

Overview of firing chamber extension (see page 86)
Accessories (see page 98)

Energy efficiency index F



Urfeuer- open fireplace 50/110

Set consists of:	Art. No.	No.	Price
Urfeuer- open fireplace 50/110 outlet ø 300 mm		1	
Mounting frame		1	
Combustion chamber inner lining made of cast iron		1	

Available variants:

Front variants:			
Mounting frame, black, 60 mm		SET212728	7724,00
Mounting frame, black, 60 mm L/R 2		SET212729	8575,50
Mounting frame, black, 60 mm L2/ R2		SET212731	9292,00

Options for the extension of the firing chamber			
Frame module 1 piece	D020006-01		543,50
Frame module double	D021006-01		643,00

Overview of firing chamber extension (see page 86)
Accessories (see page 98)

Energy efficiency index F



Urfeuer- open fireplace Eck 50/88/44 L

Set consists of:	Art. No.	No.	Price
Urfeuer- open fireplace Eck 50/88/44 L outlet ø 300 mm		1	
Mounting frame		1	
Combustion chamber inner lining made of cast iron		1	

Available variants:

Front variants:			
Mounting frame, black, 60 mm		SET212754	8072,00
Mounting frame, black, 60 mm L2,90°		SET212755	8841,00
Mounting frame, black, 60 mm L2,0°		SET212756	8788,50
Mounting frame, black, 60 mm L2,90°/ R2,0°		SET212757	9557,50
Mounting frame, black, 60 mm L2,0°/R2,0°		SET212758	9505,00
Mounting frame, black, 60 mm L2,90°/ L2,90°		SET212759	9610,00

Options for the extension of the firing chamber			
Frame module 1 piece	D020006-01		543,50
Frame module double	D021006-01		643,00

Overview of firing chamber extension (see page 86)
Accessories (see page 98)







Energy efficiency index F

Urfeuer- open fireplace Eck 50/88/44 R



Set consists of:	Art. No.	No.	Price
Urfeuer- open fireplace Eck 50/88/44 R outlet ø 300 mm		1	
Mounting frame		1	
Combustion chamber inner lining made of cast iron		1	

Available variants:

Front variants:			
Mounting frame, black, 60 mm		SET212760	8072,00
Mounting frame, black, 60 mm R2,90°		SET212761	8841,00
Mounting frame, black, 60 mm R2,0°		SET212762	8788,50
Mounting frame, black, 60 mm R2,90°/ L2,0°		SET212763	9557,50
Mounting frame, black, 60 mm R2,0°/L2,0°		SET212764	9505,00
Mounting frame, black, 60 mm R2,90°/ L2,90°		SET212765	9610,00

Options for the extension of the firing chamber			
Frame module 1 piece	D020006-01		543,50
Frame module double	D021006-01		643,00

Overview of firing chamber extension (see page 86)
Accessories (see page 98)

Energy efficiency index F



Urfeuer- open fireplace Panorama 50/44/66/44

Set consists of:	Art. No.	No.	Price
Urfeuer- open fireplace Panorama 50/44/66/44 outlet ø 300 mm		1	
Mounting frame		1	
Combustion chamber inner lining made of cast iron		1	

Additional options			
Glass panel with bracket for smoke protection	D024054		144,00

Available variants:

Front variants:			
Mounting frame, black, 60 mm		SET212707	7407,50
Mounting frame, black, 60 mm R2,90°/ L2,90°		SET212766	8945,50
Mounting frame, black, 60 mm R2,0°/L2,0°		SET212767	8840,50

Options for the extension of the firing chamber			
Frame module 1 piece	D020006-01		543,50
Frame module double	D021006-01		643,00

Overview of firing chamber extension (see page 86)

Accessories (see page 98)

Energy efficiency index F





Urfeuer- open fireplace Panorama 50/44/88/44

Set consists of:	Art. No.	No.	Price
Urfeuer- open fireplace Panorama 50/44/88/44 outlet ø 300 mm		1	
Mounting frame		1	
Combustion chamber inner lining made of cast iron		1	

Additional options			
Glass panel with bracket for smoke protection	D024054		144,00

Available variants:

Front variants:			
Mounting frame, black, 60 mm		SET212768	8033,50
Mounting frame, black, 60 mm L2,90°/ R2,90°		SET212769	9571,50
Mounting frame, black, 60 mm L2,0°/R2,0°		SET212770	9466,50

Options for the extension of the firing chamber			
Frame module 1 piece	D020006-01		543,50
Frame module double	D021006-01		643,00

Overview of firing chamber extension (see page 86)
Accessories (see page 98)

Energy efficiency index F



Urfeuer- open fireplace 4free70

Set consists of:	Art. No.	No.	Price
Urfeuer- open fireplace 4free70 outlet ø 350 mm		1	

Available variants:

Available variants:			
Urfeuer 4free70	D027001		8021,50

Additional options			
Fire table 4free70 wide 1128 x 1128 mm	D027124		765,50
Fire table 4free70 narrow 888 x 888 mm	D027125		518,00
Combustion air connection lower	D027067		237,00
Smoke protection made of glass height 475 mm	D027141		350,00
Extention of ceiling retainer	D027100		712,50
Smoke pipe ø 350, L=1000	S002050		162,00

Accessories (see page 98)

Energy efficiency index F

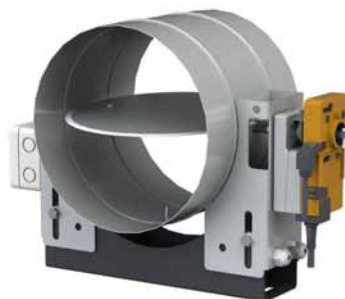
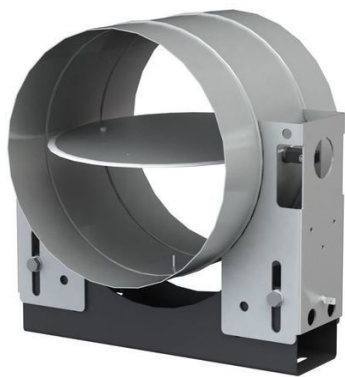

Accessories

Article description	Art. No.	Retail price
Combustion air flap		
Single flap ø 250 mm for manual operation	N003055-01	377,50
Double flap ø 250 mm for manual operation with external grate	N003085-01	575,50
Single flap ø 250 mm motorized	N003055-02	772,00
Double flap ø 250 mm motorized with external grate	N003085-02	1097,00
Dumper flaps		
Electrical damper flap ø 250 mm	E010032	647,50
Electrical damper flap ø 300 mm	E010033	647,50
Motor for electrical damper flap 4free70 (damper flap is included in delivery content of 4free70)	E010035	499,00

Article description	Art. No.	Retail price
Spare connecting piece ø 250 mm suitable for Urfeuer 50/66	D015042	105,00



Article description	Art. No.	Retail price
Modern style handle for damper flaps / smoke valves, with shaft	10275	145,00
Recessed handle for damper flaps / smoke valves, with shaft	900296	165,50



Recessed handle

Article description	Art. No.	Retail price
Flexible hose ø 250 mm for external air connection	N003104	102,50



Article description	Art. No.	Retail price
Fireclaw with blowpipe and brass mouthpiece	902005	298,00

Glazing formats

Flat glazing

from page 104



HKD 2.2
HKD 2.2 k
HKD 2.2 XL



HKD 2.6
HKD 2.6 k
HKD 6.1



HKD 4.1
HKD 5.1



WF / WFR 25
WF / WFR 33
WF / WFR 50



DF 33



HKD 7



HKD 8



HKD 13

Door dimensions height x width in cm

Tunnel formats

from page 126

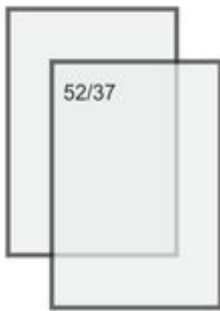

HKD 2.2
HKD 2.2 XL

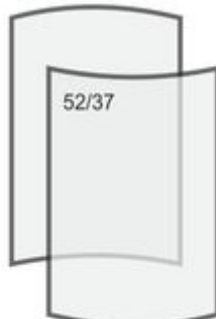

HKD 2.2 r
HKD 2.2 r XL



HKD 7



HKD 8

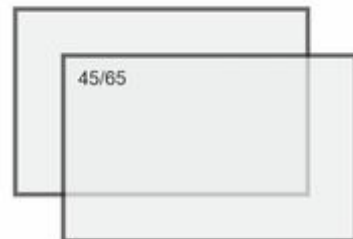

HKD 13

Door dimensions height x width in cm

Round glazing



HKD 2.2 r
HKD 2.2 r k
HKD 2.2 r XL

Door dimensions height x width in cm

Eck corners

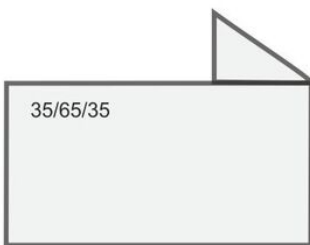

HKD 11

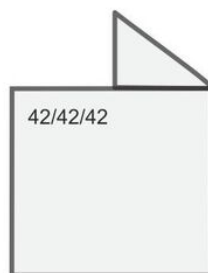

HKD 12

Door dimensions height x width x width in cm

from
page
134

flat

Tiled stoves

from
page
138

Tunnel

round

Eck

Door frame - mounting frame - Tiled stove inserts



Door frame



Mounting frame

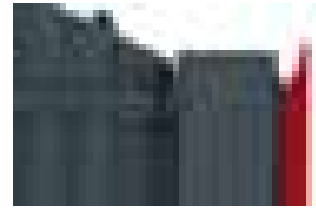

Cast iron frame

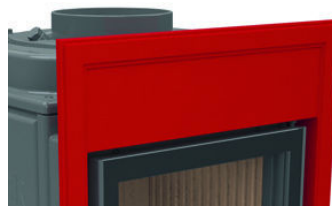
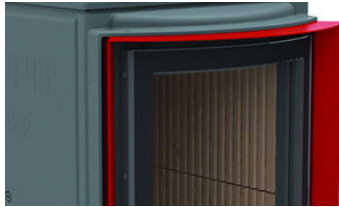
Steel front plate
42 x 79 cmCast iron front plate
42 x 79 cmSteel front plate
48 x 83 cmCast iron front plate
48 x 83 cmDoor frame
R = 330Mounting frame
R = 380

Supplementary equipment

- EAS** Combustion controls with potential-free relay (without additional functions) consisting of display, 1 x flush-mount box, door switch, thermocouple & bus line, each 2 m long. Preassembled EAS/EOS components, door switch, thermocouple, motor box with transmission and \varnothing 125 mm air flap, flexible hose with adjustable clamps
- EOS** Combustion control with graphic touchscreen display and additional functions (differential temperature control, Moritz's flap control) consisting of: Display with control unit, 2 x flush-mount box, door switch, thermocouple, bus and connecting line, each 2 m long, 4 x water sensors with immersion sleeve and 2x extension cable 3 m. Preassembled EOS components: door switch, thermocouple, motor box with transmission and \varnothing 125 mm air flap, flexible hose with adjustable clamps

flat

Tunnel

round

Eck



DF 33 double glazing for connection of a storage mass on site

Set consists of:	Art. No.	No.	Price
DF 33, double glazing		1	
Combustion chamber lining DF 33		1	
Adapter MSS / for on-site connection of a storage mass DF 33		1	

Additional options			
EAS (see page 102)			1561,50
Reduced price for EAS without display			-148,00
The EAS must be taken into account when ordering. Subsequent conversion / retrofitting is no longer possible.			
Doors with self-closing are not available!			
Motorised rotating function			1780,00
Turnbuckle for suspending of support elements (per insert 2 pieces required)	02567		15,50
Socle frame basic element	D028200		725,50

Available variants



Niche cladding 01	SET213024		7071,00
-------------------	-----------	--	----------------

Energy efficiency index A +



DF 33 double glazing with GNF 8

Set consists of:	Art. No.	No.	Price
DF 33, double glazing		1	
Combustion chamber lining DF 33		1	
MSS adapter / direct connection DF 33		1	
GNF 8 without connecting pieces		1	
GNF 8 Connecting piece, inlet ø 180		1	
GNF 8 Connecting piece, outlet ø 160		1	
Support bearing GNF 8		1	
MSS base plate 100		2	
Heat protective panel GNF 8		1	

Additional options			
EAS (see page 102)			1561,50
Reduced price for EAS without display			-148,00
The EAS must be taken into account when ordering. Subsequent conversion / retrofitting is no longer possible.			
Doors with self-closing are not available!			
Motorised rotating function			1780,00
Turnbuckle for suspending of support elements (per insert 2 pieces required)	02567		15,50
Socle frame basic element	D028200		725,50

The flue gas pipes for connection to GNF 8 and MSS must be purchased on site

Available variants



Niche cladding 01	SET213033		8350,50
-------------------	-----------	--	----------------

Energy efficiency index A +



DF 33 double glazing with Modular Accumulator MAS

Set consists of:	Art. No.	No.	Price
DF 33 , double glazing		1	
Combustion chamber lining DF 33		1	
Adapter MAS DF 33		1	
Mounting ring MAS		1	
MAS 440 accumulation stone double-layered		5	
Cast iron dome MAS		1	

Additional options

EAS (see page 102)			1561,50
Reduced price for EAS without display			-148,00

**The EAS must be taken into account when ordering.
Subsequent conversion / retrofitting is no longer possible.**

Doors with self-closing are not available!

Motorised rotating function			1780,00
Turnbuckle for suspending of support elements (per insert 2 pieces required)	02567		15,50
Socle frame basic element	D028200		725,50

Available variants



Niche cladding 01	SET213027		8737,00
-------------------	-----------	--	----------------

Energy efficiency index A +



DF 33 double glazing with MSS

Set consists of:	Art. No.	No.	Price
DF 33, double glazing		1	
Combustion chamber lining DF 33		1	
MSS adapter / direct connection DF 33		1	
MSS heat storage module 20 cm MAS		2	
MSS elbow 90°		2	
MSS inlet block ø 180, double-layered		1	
MSSI insulating block 30x30 cm		2	
MSS base plate 75		4	
MSS outlet block ø180		1	
MSS steel tape ring		7	
MSS bypass 40 with sealings		1	
MSS heat storage module 20 cm with opening		2	
MSS glue Thermofix 1000 1 kg		1	

Additional options			
EAS (see page 102)			1561,50
Reduced price for EAS without display			-148,00
The EAS must be taken into account when ordering. Subsequent conversion / retrofitting is no longer possible.			
Doors with self-closing are not available!			
Motorised rotating function			1780,00
Turnbuckle for suspending of support elements (per insert 2 pieces required)	02567		15,50
Socle frame basic element	D028200		725,50

The flue gas pipes for connection to GNF 8 and MSS must be purchased on site

Available variants



Niche cladding 01	SET213030		8146,50
-------------------	-----------	--	----------------

Energy efficiency index A +



DHT middle







HKD 2.2 side-opening door flat glass

Set consists of:	Art. No.	No.	Price
HKD 2.2 DF, single glazing		1	
Door frame or mounting frame		1	
Upper lining for HKD 2.2		1	
Inner lining set for HKD 2.2		1	
Support bearing HKD 2.2		1	







Additional options (for all smoke hood variants)			
EAS (see page 102)			1561,50
Reduced price for EAS without display			-148,00
Additional door DHT middle			1165,00
EAS at DHT			1706,50
Revision handle	02429		70,00
Double glazing			160,00

Smoke hood variants:



+ Cast iron dome \varnothing 180 mm	D009363	1	
Front variants:			
Door frame, black		SET208453	3821,50
Door frame, stainless steel		SET208454	3867,50
Mounting frame, black		SET208455	3922,50
Mounting frame, stainless steel		SET208457	4032,50
Steel front plate 48 x 83 cm		SET208459	3951,50
Cast iron front plate 48 x 83 cm		SET208460	3926,00



+ Cast iron dome \varnothing 180 mm low	D003664	1	
Front variants:			
Door frame, black		SET212881	4029,00
Door frame, stainless steel		SET212882	4075,00
Mounting frame, black		SET212883	4130,00
Mounting frame, stainless steel		SET212884	4240,00
Steel front plate 48 x 83 cm		SET212886	4159,00
Cast iron front plate 48 x 83 cm		SET212887	4133,50



+ Modular accumulator MAS 440 double-layered	R009042	5	
Cast iron cover MAS \varnothing 180	R009095-01	1	
Mounting ring	10077	1	
Front variants:			
Door frame, black		SET212825	5171,50
Door frame, stainless steel		SET212826	5217,50
Mounting frame, black		SET212827	5272,50
Mounting frame, stainless steel		SET212828	5382,50
Steel front plate 48 x 83 cm		SET212830	5301,50
Cast iron front plate 48 x 83 cm		SET212831	5276,00
Additional option MAS			
Exchange connecting piece \varnothing 200 mm	R009105		58,00
Exchange connecting piece \varnothing 160 mm	07137		58,00

Energy efficiency index A +



HKD 2.2 k side-opening door flat glass

Set consists of:	Art. No.	No.	Price
HKD 2.2 k DF, single glazing		1	
Door frame or mounting frame		1	
Inner lining set for HKD 2.2 k		1	
Upper lining for HKD 2.2 k		1	
Support bearing HKD 2.2 k		1	

Additional options			
EAS (see page 102)			1561,50
Reduced price for EAS without display			-148,00
Double glazing			160,00
MAS (see page 312)			

Available variants:

Front variants:				
Door frame, black		SET208497		3740,00
Door frame, stainless steel		SET208498		3786,00
Mounting frame, black		SET208499		3841,00
Mounting frame, stainless steel		SET208500		3951,00
Steel front plate 48 x 83 cm		SET208502		3870,00
Cast iron front plate 48 x 83 cm		SET208503		3844,50

Energy efficiency index A +





HKD 2.2 XL side-opening door flat glass

Set consists of:	Art. No.	No.	Price
HKD 2.2 XL DF, single glazing		1	
Door frame or mounting frame		1	
Inner lining set for HKD 2.2 XL		1	
Upper lining for HKD 2.2 XL		1	
Support bearing HKD 2.2 XL		1	



Additional options			
EAS (see page 102)			1561,50
Reduced price for EAS without display			-148,00
Additional door DHT middle			1165,00
EAS at DHT			1706,50
Revision handle	02429		70,00
Double glazing			160,00

Smoke hood variants:



+ Cast iron dome ø 180 mm	D009363	1	
Front variants:			
Door frame, black		SET208214	4367,50
Door frame, stainless steel		SET208215	4413,50
Mounting frame, black		SET208216	4468,50
Mounting frame, stainless steel		SET208217	4578,50
Steel front plate 48 x 83 cm		SET208268	4497,50
Cast iron front plate 48 x 83 cm		SET208269	4472,00



+ Cast iron dome ø 180 mm low	D003664	1	
Front variants:			
Door frame, black		SET212893	4575,00
Door frame, stainless steel		SET212894	4621,00
Mounting frame, black		SET212895	4676,00
Mounting frame, stainless steel		SET212896	4786,00
Steel front plate 48 x 83 cm		SET212898	4705,00
Cast iron front plate 48 x 83 cm		SET212899	4679,50

Energy efficiency index A +



HKD 2.6 side-opening door flat glass

Set consists of:	Art. No.	No.	Price
HKD 2.6 DF , Double glazing		1	
Door frame or mounting frame, front plate		1	
Upper lining for HKD 2.6		1	
Inner lining set for HKD 2.6		1	
Support bearing HKD 2.6		1	

Additional options (for all smoke hood variants)			
EAS (see page 102)			1561,50
Reduced price for EAS without display			-148,00

Smoke hood variants:





+ Cast iron dome ø 180 mm	D009363	1	
Front variants:			
Door frame, black		SET208513	3885,00
Cast iron frame black		SET208515	3898,50



+ Cast iron dome ø 180 mm low	D003664	1	
Front variants:			
Door frame, black		SET212924	4092,50
Cast iron frame black		SET212926	4106,00



+ Modular accumulator MAS 440 double-layered	R009042	5	
Cast iron cover MAS ø 180	R009095-01	1	
Mounting ring	10077	1	
Front variants:			
Door frame, black		SET212928	5235,00
Cast iron frame black		SET212930	5248,50
Additional option MAS			
Exchange connecting piece ø 200 mm	R009105		58,00
Exchange connecting piece ø 160 mm	07137		58,00

Energy efficiency index A +



HKD 2.6 k side-opening door flat glass

Set consists of:	Art. No.	No.	Price
HKD 2.6 k DF, Double glazing		1	
Door frame or mounting frame		1	
Inner lining set for HKD 2.6 k		1	
Upper lining for HKD 2.6 k		1	
Support bearing HKD 2.6 k		1	

Additional options			
EAS (see page 102)			1561,50
Reduced price for EAS without display			-148,00

Available variants:

Front variants:			
Door frame, black		SET208517	3789,00
Cast iron frame, black		SET208519	3802,50

Energy efficiency index A +

HKD 4.1 side-opening door flat glass



DHT

Set consists of:	Art. No.	No.	Price
HKD 4.1 DF , single glazing		1	
Door frame or mounting frame, front plate		1	
Inner lining set for HKD 4.1		1	
Upper lining for HKD 4.1		1	
Support bearing HKD 4.1		1	

Additional options			
EAS (see page 102)			1561,50
Reduced price for EAS without display			-148,00
Additional door DHT middle			1070,00
EAS at DHT			1706,50
Revision handle	02429		70,00
Conversion kit LH door	900110		47,50
Double glazing			0,00

Available variants:

Front variants:			
Door frame, black		SET208541	3776,50
Door frame, stainless steel		SET208542	3854,50
Mounting frame, black		SET208725	3816,50
Mounting frame, stainless steel		SET208726	3889,00
Cast iron frame		SET208544	3799,50
Steel front plate, black 48 x 83 cm		SET208545	3929,50
Cast iron front plate 48 x 83 cm		SET208547	3876,50

Energy efficiency index A +

HKD 4.1 side-opening door cast iron doors





DHT middle

Set consists of:	Art. No.	No.	Price
HKD 4.1 , cast iron doors		1	
Blend/ frontplate		1	
Inner lining set for HKD 4.1		1	
Upper lining for HKD 4.1		1	
Support bearing HKD 4.1		1	

Additional options			
EAS (see page 102)			1561,50
Reduced price for EAS without display			-148,00
Additional door DHT middle			1070,00
EAS at DHT			1706,50
Conversion kit LH door	900110		47,50
Revision handle	02429		70,00

Available variants:

Front variants:			
Cast iron frame, black		SET208558	3799,50
Cast iron front plate 48 x 83 cm		SET208559	3876,50

Energy efficiency index A +



DHT

HKD 5.1 side-opening door flat glass

Set consists of:	Art. No.	No.	Price
HKD 5.1 DF , single glazing		1	
Door frame or mounting frame, front plate		1	
Inner lining set for HKD 5.1		1	
Upper lining for HKD 5.1		1	
Support bearing HKD 5.1		1	

Additional options			
EAS (see page 102)			1561,50
Reduced price for EAS without display			-148,00
Additional door DHT middle			1070,00
EAS at DHT			1706,50
Revision handle	02429		70,00
Conversion kit LH door	900110		47,50
Double glazing			0,00

Available variants:

Front variants:				
Door frame, black		SET208574		3527,50
Door frame, stainless steel		SET208575		3605,50
Mounting frame, black		SET208729		3567,50
Mounting frame, stainless steel		SET208730		3640,00
Cast iron frame		SET208576		3550,50
Steel front plate, black 48 x 83 cm		SET208577		3680,50
Cast iron front plate 48 x 83 cm		SET208579		3627,50

Energy efficiency index A +

HKD 5.1 side-opening door cast iron doors



DHT middle

Set consists of:	Art. No.	No.	Price
HKD 5.1 , cast iron doors		1	
Blend/ frontplate		1	
Inner lining set for HKD 5.1		1	
Upper lining for HKD 5.1		1	
Support bearing HKD 5.1		1	

Additional options			
EAS (see page 102)			1561,50
Reduced price for EAS without display			-148,00
Additional door DHT middle			1070,00
EAS at DHT			1706,50
Conversion kit LH door	900110		47,50
Revision handle	02429		70,00

Available variants:

Front variants:				
Cast iron frame, black		SET208584		3550,50
Cast iron front plate 48 x 83 cm		SET208585		3627,50

Energy efficiency index A +



HKD 6.1 side-opening door flat glass

Set consists of:	Art. No.	No.	Price
HKD 6.1 DF , single glazing		1	
Blend/ frontplate		1	
Inner lining set for HKD 6.1		1	
Upper lining for HKD 6.1		1	
Support bearing HKD 6.1		1	

Additional options			
EAS (see page 102)			1561,50
Reduced price for EAS without display			-148,00
Conversion kit LH door	900110		47,50
Double glazing			0,00

Available variants:

Front variants:			
Door frame, black		SET208587	2588,00
Door frame, stainless steel		SET208588	2647,50
Cast iron frame, black		SET208589	2601,50
Steel front plate, black 42 x 79 cm		SET208590	2737,50
Steel front plate, black 48 x 83 cm		SET208592	2769,00
Cast iron front plate, 43 x 83 cm		SET210404	2735,50

Energy efficiency index A +



HKD 6.1 side-opening door cast iron doors



Set consists of:	Art. No.	No.	Price
HKD 6.1 , cast iron doors		1	
Blend/ frontplate		1	
Inner lining set for HKD 6.1		1	
Upper lining for HKD 6.1		1	
Support bearing HKD 6.1		1	

Additional options			
EAS (see page 102)			1561,50
Reduced price for EAS without display			-148,00
Conversion kit LH door	900110		47,50

Available variants:

Front variants:			
Cast iron frame, black		SET208599	2601,50
Cast iron front plate 42 x 79 cm		SET208600	2716,00
Cast iron front plate 48 x 83 cm		SET210405	2735,50

Energy efficiency index A +



HKD 7 side-opening door flat glass

Set consists of:	Art. No.	No.	Price
HKD 7 DF, single glazing		1	
Mounting frame		1	
Inner lining set for HKD 7		1	
Support bearing HKD 7		1	

Additional options (for all smoke hood variants)			
EAS (see page 102)			1561,50
Reduced price for EAS without display			-148,00
Double glazing			160,00
Door hinge self-closing	D030134		65,00

Smoke hood variants:



+ Cast iron dome ø 180 mm	D004186	1	
Front variants:			
Mounting frame, black	 SET212697		4658,00
Door frame, black	 SET212732		4672,00
Additional option for cast iron dome			
Cast iron dome ø 200 mm	10087		0,00





+ Cast iron cover ø 180 mm and cast iron heat exchanger rings	R015006-02	2	
Front variants:			
Mounting frame, black	 SET213233		5749,00
Door frame, black	 SET213234		5763,00



+ Cast iron dome ø 180 mm low	D016042	1	
Front variants:			
Mounting frame, black	 SET212708		4909,00
Door frame, black	 SET212733		4923,00



+ Modular accumulator MAS 440 double-layered	R009042	7	
Cast iron cover MAS ø 180	R009095-01	1	
Mounting ring	10077	1	
Front variants:			
Mounting frame, black	 SET212699		6481,50
Door frame, black	 SET212734		6495,50
Additional option MAS			
Exchange connecting piece ø 200 mm	R009105		58,00
Exchange connecting piece ø 160 mm	07137		58,00

Energy efficiency index A +



HKD 8 side-opening door flat glass



Set consists of:	Art. No.	No.	Price
HKD 8 DF, single glazing		1	
Inner lining set for HKD 8		1	
Support bearing HKD 8		1	

Additional options (for all smoke hood variants)			
EAS (see page 102)			1561,50
Reduced price for EAS without display			-148,00
Double glazing			160,00
Construction plates for door frame HKD 8	SET212720		166,00



Attention:
The choice of door variant (left or right closing doors) and the EOS/EAS option must be already made when placing the order. Later modifications are not possible anymore!
Selfclosing doors are not available!

Smoke hood variants:



+ Cast iron dome ø 180 mm	D004186	1	
Front variants:			
Mounting bracket, black	 SET212701		5004,50
Door frame, black	 SET212740		5492,00
Additional option for cast iron dome			
Cast iron dome ø 200 mm	10087		





+ Cast iron cover ø 180 mm and cast iron heat exchanger rings	R015006-02	2	
Front variants			
Mounting bracket, black	 SET213235		6095,50
Door frame, black	 SET213236		6583,00



+ Cast iron dome ø 180 mm low	D016042	1	
Front variants:			
Mounting bracket, black	 SET212710		5255,50
Door frame, black	 SET212741		5743,00



+ Modular accumulator MAS 440 double-layered	R009042	7	
Cast iron cover MAS ø 180	R009095-01	1	
Mounting ring	10077	1	
Front variants:			
Mounting bracket, black	 SET212702		6828,00
Door frame, black	 SET212742		7315,50
Additional option MAS			
Exchange connecting piece ø 200 mm	R009105		58,00
Exchange connecting piece ø 160 mm	07137		58,00



HKD 13 side-opening door flat glass

Set consists of:	Art. No.	No.	Price
HKD 13 DF, single glazing		1	
Mounting frame		1	
Inner lining set for HKD 13		1	
Support bearing HKD 13		1	



Additional options (for all smoke hood variants)			
EAS (see page 102)			1561,50
Reduced price for EAS without display			-148,00
ceramic glass coated (GKB)			106,00
Door hinge self-closing	D030134		65,00
Catalyst module BKH 5.0 / HKD 13	HK000210		871,00

Smoke hood variants:





+ Cast iron dome ø 180 mm	D004186	1	
Front variants:			
Mounting frame, black	 SET213249		5269,50
Door frame, black	 SET213250		5280,00
Additional option for cast iron dome			
Cast iron dome ø 200 mm	10087		0,00





+ Cast iron cover ø 180 mm and cast iron heat exchanger rings	R015006-02	2	
Front variants:			
Mounting frame, black	 SET213251		6360,50
Door frame, black	 SET213234		5763,00



+ Cast iron dome ø 180 mm low	D016042	1	
Front variants:			
Mounting frame, black	 SET213253		5520,50
Door frame, black	 SET213254		5531,00



+ Modular accumulator MAS 440 double-layered	R009042	7	
Cast iron cover MAS ø 180	R009095-01	1	
Mounting ring	10077	1	
Front variants:			
Mounting frame, black	 SET213255		7093,00
Door frame, black	 SET213256		7103,50
Additional option MAS			
Exchange connecting piece ø 200 mm	R009105		58,00
Exchange connecting piece ø 160 mm	07137		58,00

Energy efficiency index A +

WF 25 single glazed



Set consists of:	Art. No.	No.	Price
WF 25 single glazed black outlet ø 145 mm		1	
Combustion chamber lining WF 25		1	

Additional options			
*EAS (see page 102)			1561,50
Reduced price for EAS without display			-148,00
Air connecting piece	C011037		45,00
Support bearing WF 25	N002104		192,00
Exchange connecting piece ø 160 mm	07137		58,00
Exchange connecting piece ø 180 mm	07139		58,00
For version with EAS only 180 mm ø connecting piece possible			



Door-version:	Art. No.	No.	Price
Cast iron door inlay	C011106	1	117,00
Cast iron door inlay	C011106m	1	69,50
Assembly at the factory			

Available variants:

Front variants:			
Cast iron front plate 83/48 cm		SET211023	2401,50
Cast iron front plate 79/42 cm		SET211024	2401,50
Cast iron front plate 89,5/48 cm		SET211027	2529,00
Cast iron front plate 106/48 cm		SET212980	2782,50

*For the EAS variant, the air connecting piece is already included.

Energy efficiency index A +



WF 33 single glazed

Set consists of:	Art. No.	No.	Price
WF 33 single glazed black outlet ø 180 mm		1	
Combustion chamber lining WF 33		1	





Additional options

*EAS (see page 102)			1561,50
Reduced price for EAS without display			-148,00
Air connecting piece	C011037		45,00
Support bearing WF 33	N002088		192,00
Setting steel plate 200 mm depth for 106 x 48 cm front pannel	C014086		87,00
Exchange connecting piece ø 145 mm	R014013		58,00
Exchange connecting piece ø 160 mm	07137		58,00

For version with EAS only 180 mm ø connecting piece possible

Door-version:	Art. No.	No.	Price
Cast iron door inlay	C011106	1	117,00
Cast iron door inlay	C011106m	1	69,50
Assembly at the factory			

Available variants:

Front variants:				
Cast iron front plate 83/48 cm		SET211612		2401,50
Cast iron front plate 83/52 cm		SET213130		2547,00
Cast iron front plate 79/42 cm		SET211974		2401,50
Cast iron front plate 89,5/48 cm		SET211025		2529,00
Cast iron front plate 106/48 cm		SET212978		2782,50

*For the EAS variant, the air connecting piece is already included.

Energy efficiency index A +

WF 50 single glazed







Set consists of:	Art. No.	No.	Price
WF 50 single glazed black outlet ø 180 mm		1	
Combustion chamber lining WF 50		1	

Additional options			
*EAS (see page 102)			1561,50
Reduced price for EAS without display			-148,00
Air connecting piece	C011037		45,00
Support bearing WF 50	N002090		204,50
Setting steel plate 200 mm depth for 106 x 48 cm front pannel	C014086		87,00
Exchange connecting piece ø 145 mm	R014013		58,00
Exchange connecting piece ø 160 mm	07137		58,00
For version with EAS only 180 mm ø connecting piece possible			



Door-version:	Art. No.	No.	Price
Cast iron door inlay	C011106	1	117,00
Cast iron door inlay	C011106m	1	69,50
Assembly at the factory			

Available variants:

Front variants:			
Cast iron front plate 83/48 cm		SET211613	2945,00
Cast iron front plate 83/52 cm		SET213131	3090,50
Cast iron front plate 79/42 cm		SET211975	2945,00
Cast iron front plate 89,5/48 cm		SET211026	3072,50
Cast iron front plate 106/48 cm		SET212979	3326,00

*For the EAS variant, the air connecting piece is already included.

Energy efficiency index A +



WF_R 25 single glazed

Set consists of:	Art. No.	No.	Price
WF_R 25 single glazed black outlet ø 145 mm		1	
Combustion chamber lining WF _R 25		1	

Additional options

Air connecting piece	C011037		45,00
Support bearing WF _R 25	N002104		192,00
Exchange connecting piece ø 160 mm	07137		58,00
Exchange connecting piece ø 180 mm	07139		58,00



Door-version:	Art. No.	No.	Price
Cast iron door inlay	C011106	1	117,00
Cast iron door inlay	C011106m	1	69,50
Assembly at the factory			

Available variants:

Front variants:			
Cast iron front plate 83/48 cm		SET212972	2485,50
Cast iron front plate 79/42 cm		SET212973	2485,50
Cast iron front plate 89,5/48 cm		SET212974	2612,50
Cast iron front plate 106/48 cm		SET212983	2866,00

Energy efficiency index A +



WF_R 33 single glazed

Set consists of:	Art. No.	No.	Price
WF_R 33 single glazed black outlet ø 180 mm		1	
Combustion chamber lining WF _R 33		1	

Additional options			
Air connecting piece	C011037		45,00
Support bearing WF _R 33	N002088		192,00
Setting steel plate 200 mm depth for 106 x 48 cm front pannel	C014086		87,00
Exchange connecting piece ø 145 mm	R014013		58,00
Exchange connecting piece ø 160 mm	07137		58,00



Door-version:	Art. No.	No.	Price
Cast iron door inlay	C011106	1	117,00
Cast iron door inlay	C011106m	1	69,50
Assembly at the factory			

Available variants:

Front variants:			
Cast iron front plate 83/48 cm		SET212933	2485,50
Cast iron front plate 79/42 cm		SET212934	2485,50
Cast iron front plate 89,5/48 cm		SET212935	2612,50
Cast iron front plate 106/48 cm		SET212981	2866,00

Energy efficiency index A +



WF_R 50 single glazed

Set consists of:	Art. No.	No.	Price
WF_R 50 single glazed black outlet ø 180 mm		1	
Combustion chamber lining WF _R 50		1	

Additional options			
Air connecting piece	C011037		45,00
Support bearing WF _R 50	N002090		204,50
Setting steel plate 200 mm depth for 106 x 48 cm front pannel	C014086		87,00
Exchange connecting piece ø 145 mm	R014013		58,00
Exchange connecting piece ø 160 mm	07137		58,00



Door-version:	Art. No.	No.	Price
Cast iron door inlay	C011106	1	117,00
Cast iron door inlay	C011106m	1	69,50
Assembly at the factory			

Available variants:

Front variants:			
Cast iron front plate 83/48 cm		SET212975	3024,50
Cast iron front plate 79/42 cm		SET212976	3024,50
Cast iron front plate 89,5/48 cm		SET212977	3152,00
Cast iron front plate 106/48 cm		SET212982	3405,50

Energy efficiency index A +

flat

Tunnel

round

Eck



HKD 2.2 Tunnel 2 side-opening doors flat glass

Set consists of:	Art. No.	No.	Price
HKD 2.2 D/DF, single glazing		1	
Door frame or mounting frame		2	
Upper lining for HKD 2.2 Tunnel		1	
Inner lining set for HKD 2.2 Tunnel		1	
Support bearing HKD 2.2		1	

Additional options (for all smoke hood variants)			
EAS (see page 102)			1706,50
Reduced price for EAS without display			-148,00
Double glazing			320,00
Door lock as revision handle			70,00

Smoke hood variants:





+ Cast iron dome ø 180 mm	D009363	1	
Front variants:			
Door frame, black		SET208468	4722,00
Door frame, stainless steel		SET208469	4814,00
Mounting frame, black		SET208470	4924,00
Mounting frame, stainless steel		SET208471	5144,00



+ Cast iron dome ø 180 mm low	D003664	1	
Front variants:			
Door frame, black		SET212888	4929,50
Door frame, stainless steel		SET212889	5021,50
Mounting frame, black		SET212890	5131,50
Mounting frame, stainless steel		SET212891	5351,50



+ Modular accumulator MAS 440 double-layered	R009042	5	
Cast iron cover MAS ø 180	R009095-01	1	
Mounting ring	10077	1	
Front variants:			
Door frame, black		SET212832	6072,00
Door frame, stainless steel		SET212833	6164,00
Mounting frame, black		SET212834	6274,00
Mounting frame, stainless steel		SET212835	6494,00
Additional option MAS			
Exchange connecting piece ø 200 mm	R009105		58,00
Exchange connecting piece ø 160 mm	07137		58,00

Energy efficiency index A +







HKD 2.2 XL Tunnel 2 side-opening doors flat glass

Set consists of:	Art. No.	No.	Price
HKD 2.2 XL D/D F, single glazing		1	
Door frame or mounting frame		2	
Inner lining set for HKD 2.2 XL Tunnel		1	
Upper lining for HKD 2.2 XL		1	
Support bearing HKD 2.2 XL		1	

Additional options			
EAS (see page 102)			1706,50
Reduced price for EAS without display			-148,00
Double glazing			320,00
Door lock as revision handle			70,00

Smoke hood variants:



+ Cast iron dome ø 180 mm	D009363	1	
Front variants:			
Door frame, black		SET208224	5219,50
Door frame, stainless steel		SET208225	5311,50
Mounting frame, black		SET208226	5421,50
Mounting frame, stainless steel		SET208227	5641,50



+ Cast iron dome ø 180 mm, low	D003664	1	
Front variants:			
Door frame, black		SET212904	5427,00
Door frame, stainless steel		SET212905	5519,00
Mounting frame, black		SET212906	5629,00
Mounting frame, stainless steel		SET212907	5849,00

Energy efficiency index A +



HKD 2.2 Tunnel 2 side-opening doors round

Set consists of:	Art. No.	No.	Price
HKD 2.2 D/D R, single glazing		1	
Door frame or mounting frame		2	
Upper lining for HKD 2.2 Tunnel		1	
Inner lining set for HKD 2.2 Tunnel		1	
Support bearing HKD 2.2		1	

Additional options (for all smoke hood variants)			
EAS (see page 102)			1706,50
Reduced price for EAS without display			-148,00
Door lock as revision handle			70,00

Smoke hood variants:





+ Cast iron dome ø 180 mm	D009363	1	
Front variants:			
Door frame, black R = 380		SET208489	5508,00
Mounting frame, black R = 330		SET208491	5508,00



+ Cast iron dome ø 180 mm low	D003664	1	
Front variants:			
Door frame, black R = 380		SET212866	5715,50
Mounting frame, black R = 330		SET212868	5715,50



+ Modular accumulator MAS 440 double-layered	R009042	5	
Cast iron cover MAS ø 180	R009095-01	1	
Mounting ring	10077	1	
Front variants:			
Door frame, black R = 380		SET212854	6858,00
Mounting frame, black R = 330		SET212856	6858,00
Additional option MAS			
Exchange connecting piece ø 200 mm	R009105		58,00
Exchange connecting piece ø 160 mm	07137		58,00

Energy efficiency index A +

HKD 2.2 XL Tunnel 2 side-opening doors round





Set consists of:	Art. No.	No.	Price
HKD 2.2 XL D/D R, single glazing		1	
Door frame or mounting frame		2	
Inner lining set for HKD 2.2 XL Tunnel		1	
Upper lining for HKD 2.2 XL		1	
Support bearing HKD 2.2 XL		1	



Additional options			
EAS (see page 102)			1706,50
Reduced price for EAS without display			-148,00
Door lock as revision handle			70,00

Smoke hood variants:



+ Cast iron dome ø 180 mm	D009363	1	
Front variants:			
Door frame R = 380, black		SET208243	5957,00
Mounting frame R = 330, black		SET208245	5957,00



+ Cast iron dome ø 180 mm, low	D003664	1	
Door frame R = 380, black		SET212909	6164,50
Mounting frame R = 330, black		SET212911	6164,50

Energy efficiency index A +





HKD 7 Tunnel side-opening door/side-opening door flat glass

Set consists of:	Art. No.	No.	Price
HKD 7 D/D F , single glazing		1	
Mounting frame		2	
Inner lining set for HKD 7 Tunnel		1	
Support bearing HKD 7		1	

Additional options (for all smoke hood variants)			
EAS (see page 102)			1706,50
Reduced price for EAS without display			-148,00
Double glazing			320,00
Revision handle	02429		70,00
Door hinge self-closing	D030134		65,00

Smoke hood variants:



+ Cast iron dome \varnothing 180 mm	D004186	1	
Front variants:			
Mounting frame, black	 SET212698		5999,00
Door frame, black	 SET212735		6027,00
Additional option for cast iron dome			
Cast iron dome \varnothing 200 mm	10087		0,00





Cast iron cover \varnothing 180 mm and cast iron heat exchanger rings	R015006-02	2	
Front variants			
Mounting frame, black	 SET213237		7090,00
Door frame, black	 SET213238		7118,00



+ Cast iron dome \varnothing 180 mm low	D016042	1	
Front variants:			
Mounting frame, black	 SET212709		6250,00
Door frame, black	 SET212736		6278,00



+ Modular accumulator MAS 440 double-layered	R009042	7	
Cast iron cover MAS \varnothing 180	R009095-01	1	
Mounting ring	10077	1	
Front variants:			
Mounting frame, black	 SET212700		7822,50
Door frame, black	 SET212737		7850,50
Additional option MAS			
Exchange connecting piece \varnothing 200 mm	R009105		58,00
Exchange connecting piece \varnothing 160 mm	07137		58,00

Energy efficiency index A +

HKD 8 Tunnel side-opening door/side-opening door flat glass



Set consists of:	Art. No.	No.	Price
HKD 8 D/D F, single glazing		1	
Inner lining set for HKD 8 Tunnel		1	
Support bearing HKD 8		1	

Additional options (for all smoke hood variants)



EAS (see page 102)			1706,50
Reduced price for EAS without display			-148,00
Double glazing			320,00
Construction plates for door frame HKD 8	SET212720		166,00

Attention:

The choice of door variant (left or right closing doors) and the EOS/EAS option must be already made when placing the order. Later modifications are not possible anymore! Selfclosing doors are not available!

Smoke hood variants:



+ Cast iron dome ø 180 mm	D004186	1	
Front variants:			
Mounting bracket, black	 SET212703		6719,50
Door frame, black	 SET212743		7694,50
Additional option for cast iron dome			
Cast iron dome ø 200 mm	10087		0,00



+ Cast iron cover ø 180 mm and cast iron heat exchanger rings	R015006-02	2	
Front variants			
Mounting bracket, black	 SET213239		7810,50
Door frame, black	 SET213240		8785,50



+ Cast iron dome ø 180 mm low	D016042	1	
Front variants:			
Mounting bracket, black	 SET212711		6970,50
Door frame, black	 SET212744		7945,50

flat



Tiled stoves

Tunnel

round

Eck



+ Modular accumulator MAS 440 double-layered	R009042	7	
Cast iron cover MAS ø 180	R009095-01	1	
Mounting ring	10077	1	
Front variants:			
Mounting bracket, black	 SET212704		8543,00
Door frame, black	 SET212745		9518,00
Additional option MAS			
Exchange connecting piece ø 200 mm	R009105		58,00
Exchange connecting piece ø 160 mm	07137		58,00

Energy efficiency index A +

HKD 13 Tunnel side-opening door/side-opening door flat glass



Set consists of:	Art. No.	No.	Price
HKD 13 D/D F, single glazing		1	
Mounting frame / Door frame		2	
Inner lining set for HKD 13 Tunnel		1	
Support bearing HKD 13		1	

Additional options (for all smoke hood variants)			
EAS (see page 102)			1706,50
Reduced price for EAS without display			-148,00
ceramic glass coated (GKB)			212,00
Revision handle	02429		70,00
Door hinge self-closing	D030134		65,00
Catalyst module BKH 5.0 / HKD 13	HK000210		871,00

Smoke hood variants:



+ Cast iron dome ø 180 mm	D004186	1	
Front variants:			
Mounting frame, black	 SET213257		6622,00
Door frame, black	 SET213258		6643,00
Additional option for cast iron dome			
Cast iron dome ø 200 mm	10087		0,00





+ Cast iron cover ø 180 mm and cast iron heat exchanger rings	R015006-02	2	
Front variants			
Mounting frame, black	 SET213259		7713,00
Door frame, black	 SET213260		7734,00



+ Cast iron dome ø 180 mm low	D016042	1	
Front variants:			
Mounting frame, black	 SET213261		6873,00
Door frame, black	 SET213262		6894,00



+ Modular accumulator MAS 440 double-layered	R009042	7	
Cast iron cover MAS ø 180	R009095-01	1	
Mounting ring	10077	1	
Front variants:			
Mounting frame, black	 SET213263		8445,50
Door frame, black	 SET213264		8466,50
Additional option MAS			
Exchange connecting piece ø 200 mm	R009105		58,00
Exchange connecting piece ø 160 mm	07137		58,00

Energy efficiency index A +

Flat

Tiled stoves

Tunnel

round

Eck





DHT middle



HKD 2.2 side-opening door round



Set consists of:	Art. No.	No.	Price
HKD 2.2 DR, single glazing		1	
Door frame or mounting frame		1	
Upper lining for HKD 2.2		1	
Inner lining set for HKD 2.2		1	
Support bearing HKD 2.2		1	

Additional options (for all smoke hood variants)			
EAS (see page 102)			1561,50
Reduced price for EAS without display			-148,00
Additional door DHT middle			1165,00
EAS at DHT			1706,50
Revision handle	02429		70,00

Smoke hood variants:

	+ Cast iron dome ø 180 mm	D009363	1	
Front variants:				
	Door frame, black R = 380		SET208484	4237,00
	Mounting frame, black R = 330		SET208486	4237,00

	+ Cast iron dome ø 180 mm low	D003664	1	
Front variants				
	Door frame, black R = 380		SET212862	4444,50
	Mounting frame, black R = 330		SET212864	4444,50

	+ Modular accumulator MAS 440 double-layered	R009042	5	
	Cast iron cover MAS ø 180	R009095-01	1	
	Mounting ring	10077	1	
Front variants:				
	Door frame, black R = 380		SET212850	5587,00
	Mounting frame, black R = 330		SET212852	5587,00
Additional option MAS				
	Exchange connecting piece ø 200 mm	R009105		58,00
	Exchange connecting piece ø 160 mm	07137		58,00

Energy efficiency index A +





HKD 2.2 k side-opening door round

Set consists of:	Art. No.	No.	Price
HKD 2.2 k DR, single glazing		1	
Door frame or mounting frame		1	
Inner lining set for HKD 2.2 k		1	
Upper lining for HKD 2.2 k		1	
Support bearing HKD 2.2 k		1	

Additional options			
EAS (see page 102)			1561,50
Reduced price for EAS without display			-148,00
MAS (see page 312)			

Available variants:

Front variants:			
Door frame R = 380, black		SET208509	4162,50
Mounting frame R = 330, black		SET208511	4162,50

Energy efficiency index A +



DHT middle



HKD 2.2 XL side-opening door round

Set consists of:	Art. No.	No.	Price
HKD 2.2 XL DR , single glazing		1	
Door frame or mounting frame		1	
Inner lining set for HKD 2.2 XL		1	
Upper lining for HKD 2.2 XL		1	
Support bearing HKD 2.2 XL		1	



Additional options (for all smoke hood variants)			
EAS (see page 102)			1561,50
Reduced price for EAS without display			-148,00
Additional door DHT middle			1165,00
EAS at DHT			1706,50
Revision handle	02429		70,00

Smoke hood variants:



+ Cast iron dome ø 180 mm	D009363	1	
Front variants:			
Door frame R = 380, black		SET208239	4758,00
Mounting frame R = 330, black		SET208241	4758,00



+ Cast iron dome ø 180 mm low	D003664	1	
Front variants:			
Door frame R = 380, black		SET212900	4965,50
Mounting frame R = 330, black		SET212902	4965,50

Energy efficiency index A +

flat

Tunnel

round

Eck



HKD 11 Eck side-opening door left side

Set consists of:	Art. No.	No.	Price
HKD 11 Eck DTL , single glazing two-piece ceramic glass		1	
Door frame or mounting frame		1	
Inner lining set for HKD 11		1	
Additional options (for all smoke hood variants)			
EAS (see page 102)			1561,50
Reduced price for EAS without display			-148,00

Smoke hood variants:



+ Cast iron dome ø 180 mm	D004186	1	
Front variants:			
Mounting frame, black		SET213070	5137,00
Door frame, black		SET213071	5208,50
Additional option for cast iron dome			
Cast iron dome ø 200 mm	10087		0,00





+ Cast iron cover ø 180 mm and cast iron heat exchanger rings	R015006-02	2	
Front variants			
Mounting frame, black		SET213241	6228,00
Door frame, black		SET213242	6299,50



+ Cast iron dome ø 180 mm low	D016042	1	
Front variants:			
Mounting frame, black		SET213072	5388,00
Door frame, black		SET213073	5459,50



+ Modular accumulator MAS 440 double-layered	R009042	7	
Cast iron cover MAS ø 180	R009095-01	1	
Mounting ring	10077	1	
Front variants:			
Mounting frame, black		SET213074	6960,50
Door frame, black		SET213075	7032,00
Additional option MAS			
Exchange connecting piece ø 200 mm	R009105		58,00
Exchange connecting piece ø 160 mm	07137		58,00

Energy efficiency index A +



HKD 11 Eck side-opening door right side

Set consists of:	Art. No.	No.	Price
HKD 11 Eck DTR, single glazing two-piece ceramic glass		1	
Door frame or mounting frame		1	
Inner lining set for HKD 11		1	



Additional options (for all smoke hood variants)			
EAS (see page 102)			1561,50
Reduced price for EAS without display			-148,00

Smoke hood variants:



+ Cast iron dome ø 180 mm	D004186	1	
Front variants:			
Mounting frame, black		SET213076	5137,00
Door frame, black		SET213077	5208,50
Additional option for cast iron dome			
Cast iron dome ø 200 mm	10087		0,00





+ Cast iron cover ø 180 mm and cast iron heat exchanger rings	R015006-02	2	
Front variants			
Mounting frame, black		SET213243	6228,00
Door frame, black		SET213244	6299,50



+ Cast iron dome ø 180 mm low	D016042	1	
Front variants:			
Mounting frame, black		SET213078	5388,00
Door frame, black		SET213079	5459,50



+ Modular accumulator MAS 440 double-layered	R009042	7	
Cast iron cover MAS ø 180	R009095-01	1	
Mounting ring	10077	1	
Front variants:			
Mounting frame, black		SET213080	6960,50
Door frame, black		SET213081	7032,00
Additional option MAS			
Exchange connecting piece ø 200 mm	R009105		58,00
Exchange connecting piece ø 160 mm	07137		58,00

Energy efficiency index A +

Flat

Tunnel

round

Eck

Tiled stoves



HKD 12 Eck door hinge left side

Set consists of:	Art. No.	No.	Price
HKD 12 Eck door hinge left side , single glazing two-piece ceramic glass		1	
Door frame or mounting frame		1	
Combustion chamber lining HKD 12		1	

Additional options (for all smoke hood variants)

EAS (see page 102)			1561,50
Reduced price for EAS without display			-148,00

Attention:

The door variant (right- or left-closing door) must be chosen already when ordering.
Future modification is not possible !

Smoke hood variants:





+ Cast iron dome ø 180 mm	D004186	1	
Front variants:			
Mounting frame, black	 SET213132		4625,50
Door frame, black	 SET213133		4650,50
Additional option for cast iron dome			
Cast iron dome ø 200 mm	10087		0,00





+ Cast iron cover ø 180 mm and cast iron heat exchanger rings	R015006-02	2	
Front variants			
Mounting frame, black	 SET213245		5716,50
Door frame, black	 SET213246		5741,50



+ Cast iron dome ø 180 mm low	D016042	1	
Front variants:			
Mounting frame, black	 SET213134		4876,50
Door frame, black	 SET213135		4901,50



+ Modular accumulator MAS 440 double-layered	R009042	5	
Cast iron cover MAS ø 180	R009095-01	1	
Mounting ring	10077	1	
Front variants:			
Mounting frame, black	 SET213136		6019,00
Door frame, black	 SET213137		6044,00
Additional option MAS			
Exchange connecting piece ø 200 mm	R009105		58,00
Exchange connecting piece ø 160 mm	07137		58,00

Energy efficiency index A +

HKD 12 Eck door hinge right side



Set consists of:	Art. No.	No.	Price
HKD 12 Eck door hinge right side , single glazing two-piece ceramic glass		1	
Door frame or mounting frame		1	
Combustion chamber lining HKD 12		1	

Additional options (for all smoke hood variants)			
EAS (see page 102)			1561,50
Reduced price for EAS without display			-148,00

Attention:

The door variant (right- or left-closing door) must be chosen already when ordering.
Future modification is not possible !

Smoke hood variants:





+ Cast iron dome ø 180 mm	D004186	1	
Front variants:			
Mounting frame, black		SET213082	4625,50
Door frame, black		SET213083	4650,50
Additional option for cast iron dome			
Cast iron dome ø 200 mm	10087		0,00





+ Cast iron cover ø 180 mm and cast iron heat exchanger rings	R015006-02	2	
Front variants			
Mounting frame, black		SET213247	5716,50
Door frame, black		SET213248	5741,50



+ Cast iron dome ø 180 mm low	D016042	1	
Front variants:			
Mounting frame, black		SET213084	4876,50
Door frame, black		SET213085	4901,50



+ Modular accumulator MAS 440 double-layered	R009042	5	
Cast iron cover MAS ø 180	R009095-01	1	
Mounting ring	10077	1	
Front variants:			
Mounting frame, black		SET213086	6019,00
Door frame, black		SET213087	6044,00
Additional option MAS			
Exchange connecting piece ø 200 mm	R009105		58,00
Exchange connecting piece ø 160 mm	07137		58,00

Energy efficiency index A +

Warm air grating

	Art. No.	Designation	Retail price
Warm air grating for Front plate size 48/83			
	10444	Warm air grating HKD 4/5 black	437,00
	10428	Warm air grating München (HKD 4/5)	302,50
Warm air grating for Front plate size 42/79			
	10442S	Warm air grating HKD 6 black	359,00
	10437	Warm air grating suitable to Cast iron front plate HKD 6.1	259,50
Warm air grating			
	10420	Air gratings Wien	302,50
	10410	Air gratings Passau	302,50
Warm air grating with warming tube			
	10123	Air gratings Wien with warming tube	450,50
	10125	Air gratings Passau with warming tube	450,50

Art. No. black painted	Designation	warmkeeping compartment	width B	height H	clearance height C	clearance width D	mounting width E	mounting height F	depth mounting frame T	free section A
10428	Cast iron front plate 48/83		480	230	178	414	433	206	30	195
10444	Steel black front plate 48/83		480	230	187	438	455	198	48-60	243
10437	Cast iron front plate 42/79		420	220	170	370	398	196	30	150
10442S	Steel black front plate 42/79		420	230	188	378	394	196	40	193
10420	Wien	10123	450	230	165	364	420	206	30	195
10410	Passau	10125	450	230	180	414	435	206	30	210
10457	Plasterwork grille		220	70			208	59		70

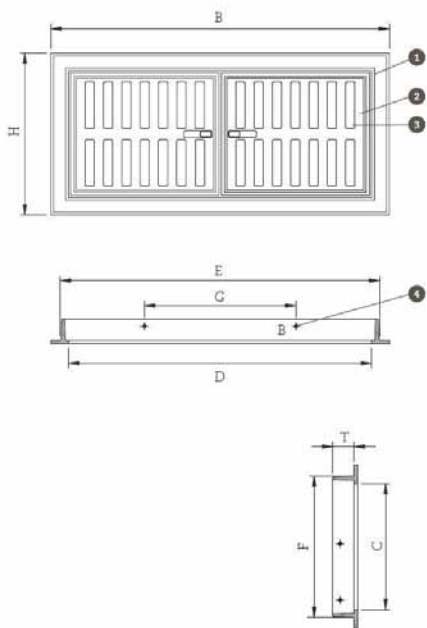

Warm air grating

- 1 grille frame
- 2 Grid door
- 3 sliding grille
- 4 fastening plate, storage tray, mounting bracket

Glazing formats

Flat glazing

from
page
146

Cast iron



Door dimensions height x width in cm

Steel



Door dimensions height x width in cm

Tunnel formats

from
page
156

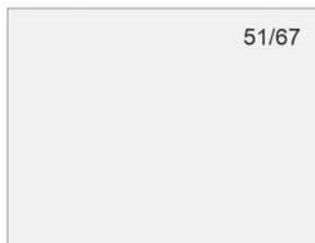

Door dimensions height x width in cm

Eck corners

from
page
158

Steel

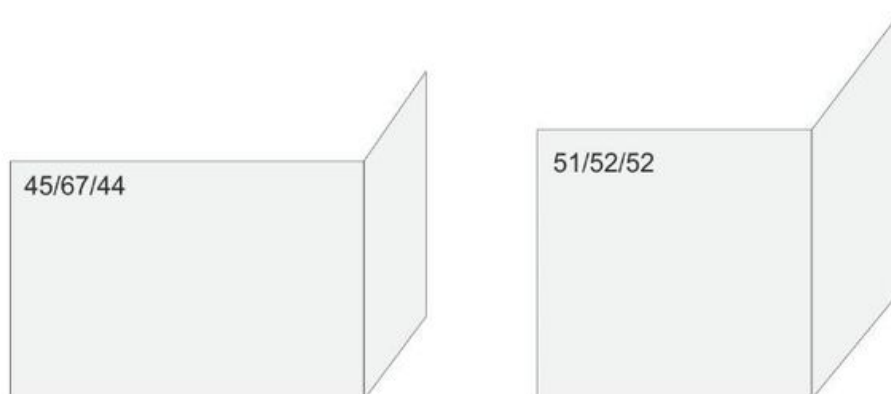

Door dimensions height x width x width in cm

Masonry heater doors

Door frame - mounting frame

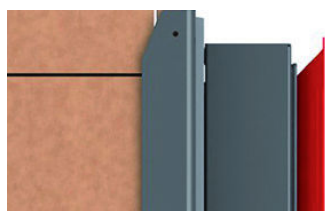

Door frame



Mounting frame

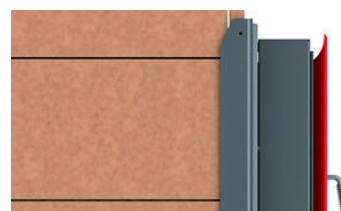

Cast iron frame

Supplementary equipment

- EAS** Combustion controls with potential-free relay (without additional functions) consisting of display, 1 x flush-mount box, door switch, thermocouple & bus line, each 2 m long. Preassembled EAS/EOS components, door switch, thermocouple, motor box with transmission and \varnothing 125 mm air flap, flexible hose with adjustable clamps
- EOS** Combustion control with graphic touchscreen display and additional functions (differential temperature control, Moritz's flap control) consisting of: Display with control unit, 2 x flush-mount box, door switch, thermocouple, bus and connecting line, each 2 m long, 4 x water sensors with immersion sleeve and 2x extension cable 3 m. Preassembled EOS components: door switch, thermocouple, motor box with transmission and \varnothing 125 mm air flap, flexible hose with adjustable clamps



GOT HBO 10

Set consists of:	Art. No.	No.	Price
Masonry heater doors HBO 10, with viewing glass		1	

Available variants:

Front variants:			
Masonry heater doors HBO 10, with viewing glass	10599		519,50

KFR 33



Set consists of:	Art. No.	No.	Price
KFR 33	G033016-01	1	2696,00

Additional options			
EAS (see page 145)			1561,50
Reduced price for EAS without display			-148,00
Installation frame 2x2,5 tile -22cm	G032122		259,00
Mausi connecting piece ø 130 mm	S004036		236,50



Door-version:	Art. No.	No.	Price
Cast iron door inlay	C011106	1	117,00
Cast iron door inlay	C011106m	1	69,50
Assembly at the factory			

Energy efficiency index A +





GOT HKD 6.1 single glazing

Set consists of:	Art. No.	No.	Price
Masonry heater doors HKD 6.1, single glazing		1	
Door frame		1	
Mounting console		1	

Additional options			
EAS (see page 145)			1561,50
Reduced price for EAS without display			-148,00
Conversion kit LH door	900110		47,50
Double glazing			0,00

Available variants:

Front variants:			
Door frame, black		SET208687	1752,00
Door frame, stainless steel		SET208688	1811,50
Cast iron frame, black		SET208689	1765,50



GOT HKD 6.1 single glazing + GOF 37x37



Set consists of:	Art. No.	No.	Price
Masonry heater doors HKD 6.1, single glazing		1	
Door frame		1	
GOF 37 x 37 with support frame		1	
Combustion chamber mortar FM 1300, bucket 10 kg		1	
Adhesive and plastering mortars Universal 600, 20 kg		1	
High temperature sealing paste cartridge 310 ml		2	

Additional options			
EAS (see page 145)			1561,50
Reduced price for EAS without display			-148,00
Conversion kit LH door	900110		47,50
Double glazing			0,00
MSS connecting block / GOF top cover	G013196		158,00
MSS connecting block / GOF side/back wall	G015107		124,00
Mausi connecting piece ø 180 mm	S004035		236,50

Available variants:

Front variants:			
Door frame, black		SET208622	3615,50
Door frame, stainless steel		SET208623	3675,00
Cast iron frame, black		SET208624	3629,00

Energy efficiency index A +



GOT HKD 6.1 cast iron doors

Set consists of:	Art. No.	No.	Price
Masonry heater doors HKD 6.1, cast iron doors		1	
Door frame		1	
Mounting console		1	

Additional options			
EAS (see page 145)			1561,50
Reduced price for EAS without display			-148,00
Conversion kit LH door	900110		47,50

Available variants:

Front variants:			
Cast iron frame, black		SET208692	1765,50



GOT HKD 6.1 cast iron doors + GOF 37x37

Set consists of:	Art. No.	No.	Price
Masonry heater doors HKD 6.1, cast iron doors		1	
Door frame		1	
GOF 37 x 37 with support frame		1	
Combustion chamber mortar FM 1300, bucket 10 kg		1	
Adhesive and plastering mortars Universal 600, 20 kg		1	
High temperature sealing paste cartridge 310 ml		2	

Additional options			
EAS (see page 145)			1561,50
Reduced price for EAS without display			-148,00
Conversion kit LH door	900110		47,50
MSS connecting block / GOF top cover	G013196		158,00
MSS connecting block / GOF side/back wall	G015107		124,00
Mausi connecting piece ø 180 mm	S004035		236,50

Available variants:

Front variants			
Cast iron frame, black		SET208654	3629,00

Energy efficiency index A +



GOT HKD 5.1/12 single glazing

Set consists of:	Art. No.	No.	Price
Masonry heater doors HKD 5.1/12 , single glazing		1	
Door frame, mounting frame, or front plate		1	
Mounting console		1	
Additional options			
EAS (see page 145)			1561,50
Reduced price for EAS without display			-148,00
Conversion kit LH door	900110		47,50
Double glazing			0,00

Available variants:

Front variants:				
Door frame, black		SET208675		1902,50
Door frame, stainless steel		SET208676		1980,50
Mounting frame, black		SET208747		1942,50
Cast iron frame, black		SET208677		1925,50

GOT HKD 5.1/12 single glazing + GOF 37x37



Set consists of:	Art. No.	No.	Price
Masonry heater doors HKD 5.1/12, single glazing		1	
Door frame, mounting frame, or front plate		1	
GOF 37 x 37 with support frame		1	
Combustion chamber mortar FM 1300, bucket 10 kg		1	
Adhesive and plastering mortars Universal 600, 20 kg		1	
High temperature sealing paste cartridge 310 ml		2	
Additional options			
EAS (see page 145)			1561,50
Reduced price for EAS without display			-148,00
Conversion kit LH door	900110		47,50
Double glazing			0,00
MSS connecting block / GOF top cover	G013196		158,00
MSS connecting block / GOF side/back wall	G015107		124,00
Mausi connecting piece ø 180 mm	S004035		236,50

Available variants:

Front variants:				
Door frame, black		SET208625		3766,00
Door frame, stainless steel		SET208626		3844,00
Mounting frame, black		SET208731		3806,00
Cast iron frame, black		SET208627		3789,00

Energy efficiency index A +



GOT HKD 5.1/12 cast iron doors

Set consists of:	Art. No.	No.	Price
Masonry heater doors HKD 5.1/12, cast iron doors		1	
Door frame or mounting frame		1	
Mounting console		1	
Additional options			
EAS (see page 145)			1561,50
Reduced price for EAS without display			-148,00
Conversion kit LH door	900110		47,50

Available variants:

Front variants:			
Cast iron frame, black		SET208680	1925,50



GOT HKD 5.1/12 cast iron doors + GOF 37x37

Set consists of:	Art. No.	No.	Price
Masonry heater doors HKD 5.1/12, cast iron doors		1	
Door frame or mounting frame		1	
GOF 37 x 37 with support frame		1	
Combustion chamber mortar FM 1300, bucket 10 kg		1	
Adhesive and plastering mortars Universal 600, 20 kg		1	
High temperature sealing paste cartridge 310 ml		2	
Additional options			
EAS (see page 145)			1561,50
Reduced price for EAS without display			-148,00
Conversion kit LH door	900110		47,50
MSS connecting block / GOF top cover	G013196		158,00
MSS connecting block / GOF side/back wall	G015107		124,00
Mausi connecting piece ø 180 mm	S004035		236,50

Available variants:

Front variants			
Door frame		SET208657	3789,00

Energy efficiency index A +



GOT HKD 5.1/20 single glazing

Set consists of:	Art. No.	No.	Price
Masonry heater doors HKD 5.1/20, single glazing		1	
Door frame, mounting frame, or front plate		1	
Mounting console		1	

Additional options			
EAS (see page 145)			1561,50
Reduced price for EAS without display			-148,00
Conversion kit LH door	900110		47,50
Double glazing			0,00

Available variants:

Front variants:				
Door frame, black		SET208681		1902,50
Door frame, stainless steel		SET208682		1980,50
Mounting frame, black		SET208751		1942,50
Cast iron frame, black		SET208683		1925,50

GOT 44/55 flat double glazing



Set consists of:	Art. No.	No.	Price
Masonry heater doors 44/55 flat, double glazing		1	
Door frame		1	
Mounting console		1	

Additional options			
EAS (see page 145)			1561,50
Reduced price for EAS without display			-148,00
Conversion kit LH door	900112		53,00

Available variants:

Front variants:				
Door frame, black		SET208693		2134,00



GOT 51/67-ZL side-opening door

Set consists of:	Art. No.	No.	Price
GOT 51/67-ZL side-opening door, single glazing		1	
Door frame		1	
Additional options			
EAS (see page 145)			1561,50
Reduced price for EAS without display			-148,00
Conversion kit right hinge door	02380		133,00
Door bricks GOT 51/67-ZL	G015020		336,00
Air connecting piece ø 160 mm	I046109		52,50
Air connecting piece ø 125 mm	02333		29,00
Double glazing			289,00

Available variants:

Front variants:			
Door frame, black		SET208701	2660,00



GOT 51/67-ZL side-opening door + GOF 66x42

Set consists of:	Art. No.	No.	Price
GOT 51/67-ZL side-opening door, single glazing		1	
Door frame		1	
GOF 66x42		1	
Combustion chamber mortar FM 1300, bucket 10 kg		1	
Adhesive and plastering mortars Universal 600, 20 kg		1	
High temperature sealing paste cartridge 310 ml		2	
Additional options			
EAS (see page 145)			1561,50
Reduced price for EAS without display			-148,00
Conversion kit right hinge door	02380		133,00
MSS connecting block / GOF top cover	G013196		158,00
MSS connecting block / GOF side/back wall	G015107		124,00
Double glazing			289,00
Mausi connecting piece ø 180 mm	S004035		236,50

Available variants:

Front variants:			
Door frame, black		SET208715	5155,00

Energy efficiency index A +



GOT 52/37-ZL side-opening door

Set consists of:	Art. No.	No.	Price
GOT 52/37-ZL side-opening door, single glazing		1	
Door frame		1	

Additional options			
EAS (see page 145)			1561,50
Reduced price for EAS without display			-148,00
Door bricks GOT 52/37-ZL	G019077		257,00
Air connecting piece ø 160 mm	I046109		52,50
Air connecting piece ø 125 mm	02333		29,00
Double glazing			160,00

Available variants:

Front variants:			
Door frame, black		SET208697	2022,50

GOT 52/37-ZL side-opening door + GOF 37x42



Set consists of:	Art. No.	No.	Price
GOT 52/37-ZL side-opening door, single glazing		1	
Door frame		1	
GOF 37x42		1	
Combustion chamber mortar FM 1300, bucket 10 kg		1	
Adhesive and plastering mortars Universal 600, 20 kg		1	
High temperature sealing paste cartridge 310 ml		2	

Additional options			
EAS (see page 145)			1561,50
Reduced price for EAS without display			-148,00
MSS connecting block / GOF top cover	G013196		158,00
MSS connecting block / GOF side/back wall	G015107		124,00
Double glazing			160,00
Mausi connecting piece ø 180 mm	S004035		236,50

Available variants:

Front variants:			
Door frame, black		SET208709	4089,00

Energy efficiency index A +



GOT 51/67-ZL 2 side-opening doors + GOF Tunnel 66x36

Set consists of:	Art. No.	No.	Price
GOT 51/67-ZL side-opening door, single glazing		2	
Door frame		2	
GOF-Tunnel 66x36		1	
Combustion chamber mortar FM 1300, bucket 10 kg		1	
Adhesive and plastering mortars Universal 600, 20 kg		1	
High temperature sealing paste cartridge 310 ml		2	

Additional options			
EAS (see page 145)			1706,50
Reduced price for EAS without display			-148,00
Conversion kit right hinge door	02380		133,00
Door lock as revision handle	02426		130,00
MSS connecting block / GOF top cover	G017110		144,50
MSS connecting block / GOF side	G015108		124,00
Double glazing (also one side only available on request)			578,00
Mausi connecting piece ø 180 mm	S004035		236,50

Available variants:

Front variants:			
Door frame, black		SET210504	7914,50

Energy efficiency index A +

Flat

Tunnel

Eck



GOT 51/52/52-ZL side-opening door

Set consists of:	Art. No.	No.	Price
GOT 51/52/52-ZL, single glazing two-piece ceramic glass		1	
Door frame		1	

Additional options			
EAS (see page 145)			1561,50
Reduced price for EAS without display			-148,00
Conversion kit right hinge door	02380		133,00
Door bricks GOT 51/52/52-ZL	G018032		336,00
Air connecting piece ø 160 mm	I046109		52,50
Air connecting piece ø 125 mm	02333		29,00

Available variants:

Front variants:			
Door frame, black		SET208707	3820,00

GOT 51/52/52-ZL side-opening door + GOF 35x35



Set consists of:	Art. No.	No.	Price
GOT 51/52/52-ZL, single glazing two-piece ceramic glass		1	
Door frame		1	
GOF 35x35		1	
Combustion chamber mortar FM 1300, bucket 10 kg		1	
Adhesive and plastering mortars Universal 600, 20 kg		1	
High temperature sealing paste cartridge 310 ml		2	

Additional options			
EAS (see page 145)			1561,50
Reduced price for EAS without display			-148,00
Conversion kit right hinge door	02380		133,00
MSS connecting block / GOF top cover	G021138		144,50
MSS connecting block / GOF right side	G023205		124,00
MSS connecting block / GOF left side	G023204		124,00
Mausi connecting piece ø 180 mm	S004035		236,50

Available variants:

Front variants:			
Door frame, black		SET208719	5429,50

Energy efficiency index A +

GOT 45/67/44-ZL side-opening door L



Set consists of:	Art. No.	No.	Price
GOT 45/67/44-ZL L , single glazing two-piece ceramic glass		1	
Door frame		1	

Additional options			
EAS (see page 145)			1561,50
Reduced price for EAS without display			-148,00
Door bricks GOT 45/67/44-ZL L	G025053		398,00
Air connecting piece \varnothing 160 mm	I046109		52,50
Air connecting piece \varnothing 125 mm	02333		29,00

Available variants:

Front variants:			
Door frame, black		SET210924	4211,00

GOT 45/67/44-ZL side-opening door L + GOF 50x35



Set consists of:	Art. No.	No.	Price
GOT 45/67/44-ZL L , single glazing two-piece ceramic glass		1	
Door frame		1	
GOF-Tunnel 50x35		1	
Combustion chamber mortar FM 1300, bucket 10 kg		1	
Adhesive and plastering mortars Universal 600, 20 kg		1	
High temperature sealing paste cartridge 310 ml		2	

Additional options			
EAS (see page 145)			1561,50
Reduced price for EAS without display			-148,00
MSS connecting block / GOF top cover	G021138		144,50
MSS connecting block / GOF right side	G023205		124,00
MSS connecting block GOF backwall	G015107		124,00
Mausi connecting piece \varnothing 180 mm	S004035		236,50

Available variants:

Front variants:			
Door frame, black		SET210928	6397,00
Door frame, stainless steel		SET210929	6556,50

Energy efficiency index A +





GOT 45/67/44-ZL lifting door L

Set consists of:	Art. No.	No.	Price
GOT 45/67/44-ZL STL, single glazing two-piece ceramic glass		1	
Mounting frame		1	

Additional options			
EAS (see page 145)			1561,50
Reduced price for EAS without display			-148,00
Door bricks GOT 45/67/44-ZL L	G025053		398,00
Air connecting piece ø 160 mm	I046109		52,50
Air connecting piece ø 125 mm	O2333		29,00
Counterweights for non-self closing door	49097		46,50

Available variants:

Front variants:			
Mounting frame, black 50 mm		G025093-11	4663,00
Mounting frame, black 70 mm		G025093-13	4798,50

GOT 45/67/44-ZL lifting door L + GOF 50x35



Set consists of:	Art. No.	No.	Price
GOT 45/67/44-ZL STL, single glazing two-piece ceramic glass		1	
Mounting frame		1	
GOF 50x35		1	
Combustion chamber mortar FM 1300, bucket 10 kg		1	
Adhesive and plastering mortars Universal 600, 20 kg		1	
High temperature sealing paste cartridge 310 ml		2	

Additional options			
EAS (see page 145)			1561,50
Reduced price for EAS without display			-148,00
MSS connecting block / GOF top cover	G021138		144,50
MSS connecting block / GOF right side	G023205		124,00
MSS connecting block GOF backwall	G015107		124,00
Mausi connecting piece ø 180 mm	S004035		236,50
Counterweights for non-self closing door	49097		46,50

Available variants:

Front variants:			
Mounting frame, black 50 mm		G025094-11	6818,00
Mounting frame, black 70 mm		G025094-13	6954,00

Energy efficiency index A +



GOT 45/67/44-ZL side-opening door R

Set consists of:	Art. No.	No.	Price
GOT 45/67/44-ZL R , single glazing two-piece ceramic glass		1	
Door frame		1	

Additional options			
EAS (see page 145)			1561,50
Reduced price for EAS without display			-148,00
Door bricks GOT 45/67/44-ZL R	G025026		398,00
Air connecting piece \varnothing 160 mm	I046109		52,50
Air connecting piece \varnothing 125 mm	02333		29,00

Available variants:

Front variants:			
Door frame, black		set210922	4211,00



GOT 45/67/44-ZL side-opening door R + GOF 50x35

Set consists of:	Art. No.	No.	Price
GOT 45/67/44-ZL R , single glazing two-piece ceramic glass		1	
Door frame		1	
GOF 50x35		1	
Combustion chamber mortar FM 1300, bucket 10 kg		1	
Adhesive and plastering mortars Universal 600, 20 kg		1	
High temperature sealing paste cartridge 310 ml		2	

Additional options			
EAS (see page 145)			1561,50
Reduced price for EAS without display			-148,00
MSS connecting block / GOF top cover	G021138		144,50
MSS connecting block / GOF left side	G023204		124,00
MSS connecting block GOF backwall	G015107		124,00
Mausi connecting piece \varnothing 180 mm	S004035		236,50

Available variants:

Front variants:			
Door frame, black		SET210926	6397,00

Energy efficiency index A +





GOT 45/67/44-ZL lifting door R

Set consists of:	Art. No.	No.	Price
GOT 45/67/44-ZL STR , single glazing two-piece ceramic glass		1	
Mounting frame		1	

Additional options			
EAS (see page 145)			1561,50
Reduced price for EAS without display			-148,00
Door bricks GOT 45/67/44-ZL R	G025026		398,00
Air connecting piece ø 160 mm	I046109		52,50
Air connecting piece ø 125 mm	O2333		29,00
Counterweights for non-self closing door	49097		46,50

Available variants:

Front variants:			
Mounting frame, black 50 mm		G025058-11	4663,00
Mounting frame, black 70 mm		G025058-13	4798,50



GOT 45/67/44-ZL lifting door R + GOF 50x35



Set consists of:	Art. No.	No.	Price
GOT 45/67/44-ZL STR , single glazing two-piece ceramic glass		1	
Mounting frame		1	
GOF 50x35		1	
Combustion chamber mortar FM 1300, bucket 10 kg		1	
Adhesive and plastering mortars Universal 600, 20 kg		1	
High temperature sealing paste cartridge 310 ml		2	

Additional options			
EAS (see page 145)			1561,50
Reduced price for EAS without display			-148,00
MSS connecting block / GOF top cover	G021138		144,50
MSS connecting block / GOF left side	G023204		124,00
MSS connecting block GOF backwall	G015107		124,00
Mausi connecting piece ø 180 mm	S004035		236,50
Counterweights for non-self closing door	49097		46,50

Available variants:

Front variants:			
Mounting frame, black 50 mm		G025088-11	6818,00
Mounting frame, black 70 mm		G025088-13	6954,00

Energy efficiency index A +

Flat

Tunnel

Eck

Glazing formats

Flat glazing



KSO 33q

Door dimensions height x width in cm

from
page
166

Round glazing



KSO 33r

Door dimensions height x width in cm

from
page
168

Mounting frame- Accumulation stove



Mounting frame

Supplementary equipment

- EAS** Combustion controls with potential-free relay (without additional functions) consisting of display, 1 x flush-mount box, door switch, thermocouple & bus line, each 2 m long. Preassembled EAS/EOS components, door switch, thermocouple, motor box with transmission and \varnothing 125 mm air flap, flexible hose with adjustable clamps
- EOS** Combustion control with graphic touchscreen display and additional functions (differential temperature control, Moritz's flap control) consisting of: Display with control unit, 2 x flush-mount box, door switch, thermocouple, bus and connecting line, each 2 m long, 4 x water sensors with immersion sleeve and 2x extension cable 3 m. Preassembled EOS components: door switch, thermocouple, motor box with transmission and \varnothing 125 mm air flap, flexible hose with adjustable clamps



KSO 33q, with thermal concrete cladding

Set consists of:	Art. No.	No.	Price
Accumulation stove KSO 33q , horizontal outlet		1	
Firebox KSO 33 ø 540 mm		1	
Top-mount accumulator KSO 33 ø 540 mm		1	
Front with doors (44 x 33), flat glass		1	
KSO 33 Firebox support frame		1	
High temperature sealing paste		1	
Mounting frame according table		1	
Smoke pipe connection ø 130 mm, horizontal		1	
Cover for smoke pipe connecting piece ø 130 mm, horizontal		1	
Thermal concrete cladding		1	

Additional options

Conversion kit for vertical outlet instead of horizontal smoke pipe connection (G022158) a vertical smoke pipe connection (G020405) is delivered			0,00
Conversion kit LH door	900110		47,50

Available variants:

Front variants			
Mounting frame, black		SET211386	6344,00

Energy efficiency index A +

flat

KSO

round

KSO 33q, with thermal concrete cladding + EAS



Set consists of:	Art. No.	No.	Price
Accumulation stove KSO 33q, horizontal outlet		1	
Firebox KSO 33 ø 540 mm		1	
Top-mount accumulator KSO 33 ø 540 mm		1	
Front with doors (44 x 33), flat glass		1	
KSO 33 Firebox support frame		1	
High temperature sealing paste		1	
Mounting frame according table		1	
Smoke pipe connection ø 130 mm, horizontal		1	
Cover for smoke pipe connecting piece ø 130 mm, horizontal		1	
Thermal concrete cladding		1	
EAS (see page 165)		1	
Mounting box		1	
Door switch wiring 3 lm		1	
Thermocouple wiring 3 lm		1	
Bus wiring 3 lm		1	

Additional options			
Conversion kit for vertical outlet instead of horizontal smoke pipe connection (G022158) a vertical smoke pipe connection (G020405) is delivered			0,00
Conversion kit LH door	900110		47,50
Reduced price for EAS without display			-148,00

Available variants:

Front variants			
Mounting frame, black		SET211388	7931,00

Energy efficiency index A +



KSO 33r, with thermal concrete cladding

Set consists of:	Art. No.	No.	Price
Accumulation stove KSO 33r , horizontal outlet		1	
Firebox KSO 33 ø 540 mm		1	
Top-mount accumulator KSO 33 ø 540 mm		1	
Front with doors (44 x 33), round glass		1	
KSO 33 Firebox support frame		1	
High temperature sealing paste		1	
Mounting frame according table		1	
Smoke pipe connection ø 130 mm, horizontal		1	
Cover for smoke pipe connecting piece ø 130 mm, horizontal		1	
Thermal concrete cladding		1	

Additional options

Conversion kit for vertical outlet instead of horizontal smoke pipe connection (G022158) a vertical smoke pipe connection (G020405) is delivered instead cover for horizontal smoke pipe connection (G020416) delivery contains a vertical smoke pipe con- nection (G020418)			0,00
Conversion kit LH door	900110		47,50

Available variants:

Front variants			
Mounting frame, black, 330 mm		SET211394	6259,50

Energy efficiency index A +

KSO 33r, with thermal concrete cladding + EAS



Set consists of:	Art. No.	No.	Price
Accumulation stove KSO 33r, horizontal outlet		1	
Firebox KSO 33 ø 540 mm		1	
Top-mount accumulator KSO 33 ø 540 mm		1	
Front with doors (44 x 33), round glass		1	
KSO 33 Firebox support frame		1	
High temperature sealing paste		1	
Mounting frame according table		1	
Smoke pipe connection ø 130 mm, horizontal		1	
Cover for smoke pipe connecting piece ø 130 mm, horizontal		1	
Thermal concrete cladding		1	
EAS (see page 165)		1	
Mounting box		1	
Door switch wiring 3 lm		1	
Thermocouple wiring 3 lm		1	
Bus wiring 3 lm		1	

Additional options

Conversion kit for vertical outlet instead of horizontal smoke pipe connection (G022158) a vertical smoke pipe connection (G020405) is delivered instead cover for horizontal smoke pipe connection (G020416) delivery contains a vertical smoke pipe connection (G020418)			0,00
Conversion kit LH door	900110		47,50
Reduced price for EAS without display			-148,00

Available variants:

Front variants			
Mounting frame, black, 330 mm		SET211396	7846,50

Energy efficiency index A +

Glazing formats

Flat glazing



BSO 02, 03, 04
Door dimensions height x width in cm



BSO 05

from
page
172

Tunnel formats



BSO 02, 03
Door dimensions height x width in cm



BSO 05

from
page
178

Round glazing



BSO 1
Door dimensions height x width in cm

from
page
184

Mounting frame- System stoves



Mounting frame

Supplementary equipment

- EAS** Combustion controls with potential-free relay (without additional functions) consisting of display, 1 x flush-mount box, door switch, thermocouple & bus line, each 2 m long. Preassembled EAS/EOS components, door switch, thermocouple, motor box with transmission and \varnothing 125 mm air flap, flexible hose with adjustable clamps
- EOS** Combustion control with graphic touchscreen display and additional functions (differential temperature control, Moritz's flap control) consisting of: Display with control unit, 2 x flush-mount box, door switch, thermocouple, bus and connecting line, each 2 m long, 4 x water sensors with immersion sleeve and 2x extension cable 3 m. Preassembled EOS components: door switch, thermocouple, motor box with transmission and \varnothing 125 mm air flap, flexible hose with adjustable clamps



BSO 02

Set consists of:	Art. No.	No.	Price
HKD 2.2, side-opening door, single glazed		1	
Chamotte lining set HKD 2.2		1	
Upper lining HKD 2.2		1	
Mounting frame		1	
Modular top-mount accumulator		5	
Cast iron cover MAS ø 180 horizontal/ vertical		1	
Mounting ring for modular top-mount storage		1	
Thermal concrete cladding BSO 02		1	

Additional options

Additional ring (top ring 1), raised cladding for BSO 02 (326 mm) *	BSO2000-006		228,00
* Differences of colour between the height extension ring and other components of BSK/BSO are due to manufacturing process and cannot be excluded. These colour differences are no reason for a claim.			
Double glazing			160,00
Heat protective panel BSO 02 (suitable for back wall or side wall)	BSO3000-034		83,00

Available variants:

Front variants			
Mounting frame, black		SET211302	5839,00
Mounting frame, stainless steel		SET211303	5949,00

Energy efficiency index A +



BSO 02 + EAS

Set consists of:	Art. No.	No.	Price
HKD 2.2, side-opening door, single glazed		1	
Chamotte lining set HKD 2.2		1	
Upper lining HKD 2.2		1	
Mounting frame		1	
Modular top-mount accumulator		5	
Cast iron cover MAS ø 180 horizontal/ vertical		1	
Mounting ring for modular top-mount storage		1	
Thermal concrete cladding BSO 02		1	
EAS (see page 165)		1	
Mounting box		1	
Door switch wiring 3 lm		1	
Thermocouple wiring 3 lm		1	
Bus wiring 3 lm		1	

Additional options			
Additional ring (top ring 1), raised cladding for BSO 02 (326 mm) *	BSO2000-006		228,00
* Differences of colour between the height extension ring and other components of BSK/BSO are due to manufacturing process and cannot be excluded. These colour differences are no reason for a claim.			
Double glazing			160,00
Heat protective panel BSO 02 (suitable for back wall or side wall)	BSO3000-034		83,00
Reduced price for EAS without display			-148,00

Available variants:

Front variants			
Mounting frame, black		SET211316	7426,00
Mounting frame, stainless steel		SET211317	7536,00

Energy efficiency index A +



BSO 03

Set consists of:	Art. No.	No.	Price
HKD 2.2, side-opening door, single glazed		1	
Chamotte lining set HKD 2.2		1	
Upper lining HKD 2.2		1	
Mounting frame		1	
heat storage block BSO 03		1	
Segmental bend 45°		1	
Pipe conversion piece ø 180 mm, 90° assembly kit		1	
Thermal concrete cladding BSO 02		1	
Thermal concrete cladding heat storage block		1	

Additional options			
Additional ring (top ring 1); raised cladding for BSO 03 storage block (290 mm high) *	BSO3000-004		221,50
Additional ring (top ring 1), raised cladding for BSO 02 (326 mm) *	BSO2000-006		228,00
* Differences of colour between the height extension ring and other components of BSK/BSO are due to manufacturing process and cannot be excluded. These colour differences are no reason for a claim.			
Double glazing			160,00
Heat protective panel BSO 03 (suitable for side-wall/ Heat protective panel backwall included in delivery contents)	BSO3000-034		83,00

Available variants:

Front variants			
Mounting frame, black		SET211308	7792,00
Mounting frame, stainless steel		SET211309	7902,00

Energy efficiency index A +

BSO 03 + EAS



Set consists of:	Art. No.	No.	Price
HKD 2.2, side-opening door, single glazed		1	
Chamotte lining set HKD 2.2		1	
Upper lining HKD 2.2		1	
Mounting frame		1	
heat storage block BSO 03		1	
Segmental bend 45°		1	
Pipe conversion piece ø 180 mm, 90 ° assembly kit		1	
Thermal concrete cladding BSO 02		1	
Thermal concrete cladding heat storage block		1	
EAS (see page 165)		1	
Mounting box		1	
Door switch wiring 3 lm		1	
Thermocouple wiring 3 lm		1	
Bus wiring 3 lm		1	

Additional options

Additional ring (top ring 1) raised cladding for BSO 03 storage block (290 mm high) *	BSO3000-004		221,50
Additional ring (top ring 1); raised cladding for BSO 02 (326 mm) *	BSO2000-006		228,00
* Differences of colour between the height extension ring and other components of BSK/BSO are due to manufacturing process and cannot be excluded. These colour differences are no reason for a claim.			
Double glazing			160,00
Heat protective panel BSO 03 (suitable for side-wall/ Heat protective panel backwall included in delivery contents)	BSO3000-034		83,00
Reduced price for EAS without display			-148,00

Available variants:

Front variants			
Mounting frame, black		SET211322	9379,00
Mounting frame, stainless steel		SET211323	9489,00

Energy efficiency index A +



BSO 04

Set consists of:	Art. No.	No.	Price
HKD 2.2 k SK, side-opening door, single glazed		1	
Chamotte lining set HKD 2.2 k SK		1	
Upper lining HKD 2.2 k SK		1	
Mounting frame		1	
Thermal concrete cladding BSO 04		1	

Additional options			
Additional ring (top ring 1), Raised cladding for BSO 04 (412 mm) *	BSO4000-006		376,50
* Differences of colour between the height extension ring and other components of BSK/BSO are due to manufacturing process and cannot be excluded. These colour differences are no reason for a claim.			
Double glazing			160,00
Set heat-protective panel	BSK12000-124		43,50

Available variants:

Front variants			
Mounting frame, black		SET211470	6387,00
Mounting frame, stainless steel		SET211471	6497,00

Energy efficiency index A +

BSO 04 + EAS

Set consists of:	Art. No.	No.	Price
HKD 2.2 k SK, side-opening door, single glazed		1	
Chamotte lining set HKD 2.2 k SK		1	
Upper lining HKD 2.2 k SK		1	
Mounting frame		1	
Thermal concrete cladding BSO 04		1	
EAS (see page 165)		1	
Mounting box		1	
Door switch wiring 2 lm		1	
Thermocouple wiring 2 lm		1	
Bus wiring 2 lm		1	

Additional options			
Reduced price for EAS without display			-148,00
Additional ring (top ring 1), Raised cladding for BSO 04 (412 mm) *	BSO4000-006		376,50
* Differences of colour between the height extension ring and other components of BSK/BSO are due to manufacturing process and cannot be excluded. These colour differences are no reason for a claim.			
Double glazing			160,00
Set heat-protective panel	BSK12000-124		43,50
Add. charge EOS ¹			1267,50

Available variants:

Front variants			
Mounting frame, black		SET211473	7948,50
Mounting frame, stainless steel		SET211474	8058,50

¹compared to EAS: EOS control & display unit, second flush-mount box, connecting cable for control & display unit 2m long, 4x water temperature sensor with sleeve and 2x extension cable 3m long.

Energy efficiency index A +

BSO 05 + EAS



Set consists of:	Art. No.	No.	Price
HKD 7 SK, side-opening door, single glazed		1	
Chamotte lining set HKD 7 SK		1	
Upper lining HKD 7 SK		1	
Mounting frame		1	
Thermal concrete cladding BSO 05		1	
EAS (see page 165)		1	
Mounting box		1	
Door switch wiring 2 lm		1	
Thermocouple wiring 2 lm		1	
Bus wiring 2 lm		1	
Connecting piece for side/rear smoke outlet ø 180 mm		1	

Additional options			
Reduced price for EAS without display			-148,00
Additional ring (top ring 1), Extending element for BSO 05 (312 mm) *	BSO5000-007		305,00
* Differences of colour between the height extension ring and other components of BSK/BSO are due to manufacturing process and cannot be excluded. These colour differences are no reason for a claim.			
Double glazing			160,00
Set heat-protective panel	BSO5000-120		54,50
Add. charge EOS ¹			1267,50
Smoke pipe outlet on top ø 180 mm	W043140		0,00
Conversion kit for cleaning on top including push-in handle	BSO5000-123		212,00

Available variants:

Front variants			
Mounting frame, black		SET213016	12815,00

¹compared to EAS: EOS control & display unit, second flush-mount box, connecting cable for control & display unit 2m long, 4x water temperature sensor with sleeve and 2x extension cable 3m long.

Energy efficiency index A +



BSO 02 Tunnel

Set consists of:	Art. No.	No.	Price
HKD 2.2 Tunnel , 2 side-opening doors, single glazed		1	
Chamotte lining set HKD 2.2 Tunnel		1	
Upper lining HKD 2.2 für BSO 02		1	
Mounting frame		2	
Modular top-mount accumulator		5	
Cast iron cover MAS ø 180 horizontal/ vertical		1	
Mounting ring for modular top-mount storage		1	
Thermal concrete cladding BSO 02		1	

Additional options

Additional ring (top ring 1), raised cladding for BSO 02 (326 mm) *	BSO2000-006		228,00
* Differences of colour between the height extension ring and other components of BSK/BSO are due to manufacturing process and cannot be excluded. These colour differences are no reason for a claim.			
Door lock as revision handle	02429		70,00
Double glazing (also one side only available on request)			320,00
Heat protective panel BSO 02 (sidewall)	BSO3000-034		83,00

Available variants:

Front variants			
Mounting frame, black		SET211305	6840,50
Mounting frame, stainless steel		SET211306	7060,50

Energy efficiency index A +



BSO 02 Tunnel + EAS

Set consists of:	Art. No.	No.	Price
HKD 2.2 Tunnel , 2 side-opening doors, single glazed		1	
Chamotte lining set HKD 2.2 Tunnel		1	
Upper lining HKD 2.2 für BSO 02		1	
Mounting frame		2	
Modular top-mount accumulator		5	
Cast iron cover MAS ø 180 horizontal/ vertical		1	
Mounting ring for modular top-mount storage		1	
Thermal concrete cladding BSO 02		1	
EAS (see page 165)		1	
Mounting box		1	
Door switch wiring 3 lm		1	
Thermocouple wiring 3 lm		1	
Bus wiring 3 lm		1	

Additional options			
Additional ring (top ring 1), raised cladding for BSO 02 (326 mm) *	BSO2000-006		228,00
* Differences of colour between the height extension ring and other components of BSK/BSO are due to manufacturing process and cannot be excluded. These colour differences are no reason for a claim.			
Door lock as revision handle	02429		70,00
Double glazing			320,00
Heat protective panel BSO 02 (sidewall)	BSO3000-034		83,00
Reduced price for EAS without display			-148,00

Available variants:

Front variants			
Mounting frame, black		SET211319	8572,50
Mounting frame, stainless steel		SET211320	8792,50

Energy efficiency index A +



BSO 03 Tunnel

Set consists of:	Art. No.	No.	Price
HKD 2.2 Tunnel , 2 side-opening doors, single glazed		1	
Chamotte lining set HKD 2.2		1	
Upper lining HKD 2.2		1	
Mounting frame		2	
heat storage block BSO 03		1	
Segmental bend 45°		1	
Pipe conversion piece ø 180 mm, 90° assembly kit		1	
Thermal concrete cladding BSO 02		1	
Thermal concrete cladding heat storage block		1	

Additional options

Additional ring (top ring 1), raised cladding for BSO 03 storage block (290 mm high) *	BSO3000-004		221,50
Additional ring (top ring 1), raised cladding for BSO 02 (326 mm) *	BSO2000-006		228,00
* Differences of colour between the height extension ring and other components of BSK/BSO are due to manufacturing process and cannot be excluded. These colour differences are no reason for a claim.			
Double glazing			320,00

Available variants:

Front variants			
Mounting frame, black		SET211311	8793,50
Mounting frame, stainless steel		SET211312	9013,50

Energy efficiency index A +

BSO 03 Tunnel + EAS

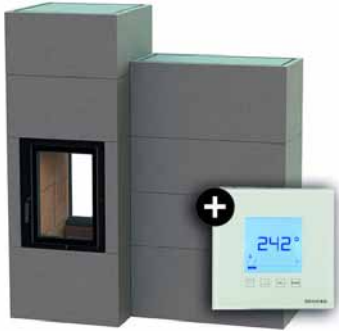

Set consists of:	Art. No.	No.	Price
HKD 2.2 Tunnel , 2 side-opening doors, single glazed		1	
Chamotte lining set HKD 2.2		1	
Upper lining HKD 2.2		1	
Mounting frame		2	
heat storage block BSO 03		1	
Segmental bend 45°		1	
Pipe conversion piece ø 180 mm, 90° assembly kit		1	
Thermal concrete cladding BSO 02		1	
Thermal concrete cladding heat storage block		1	
EAS (see page 165)		1	
Mounting box		1	
Door switch wiring 3 lm		1	
Thermocouple wiring 3 lm		1	
Bus wiring 3 lm		1	

Additional options			
Additional ring (top ring 1); raised cladding for BSO 03 storage block (290 mm high) *	BSO3000-004		221,50
Additional ring (top ring 1), raised cladding for BSO 02 (326 mm) *	BSO2000-006		228,00
* Differences of colour between the height extension ring and other components of BSK/BSO are due to manufacturing process and cannot be excluded. These colour differences are no reason for a claim.			
Double glazing			320,00
Reduced price for EAS without display			-148,00

Available variants:

Front variants			
Mounting frame, black		SET211325	10525,50
Mounting frame, stainless steel		SET211326	10745,50

Energy efficiency index A +



BSO 05 Tunnel + EAS

Set consists of:	Art. No.	No.	Price
HKD 7 SK Tunnel , side-opening door, single glazed		1	
Chamotte lining set HKD 7 SK Tunnel		1	
Upper lining HKD 7 SK		1	
Mounting frame		2	
Thermal concrete cladding BSO 05		1	
EAS (see page 165)		1	
Mounting box		1	
Door switch wiring 2 lm		1	
Thermocouple wiring 2 lm		1	
Bus wiring 2 lm		1	
Connecting piece for side/rear smoke outlet ø 180 mm		1	

Additional options

Reduced price for EAS without display			-148,00
Additional ring (top ring 1), Extending element for BSO 05 (312 mm) *	BSO5000-007		305,00
* Differences of colour between the height extension ring and other components of BSK/BSO are due to manufacturing process and cannot be excluded. These colour differences are no reason for a claim.			
Double glazing			320,00
Add. charge EOS ¹			1267,50
Smoke pipe outlet on top ø 180 mm	W043140		0,00
Conversion kit for cleaning on top including push-in handle	BSO5000-123		212,00

Available variants:

Front variants			
Mounting frame, black		SET213017	14522,00

¹compared to EAS: EOS control & display unit, second flush-mount box, connecting cable for control & display unit 2m long, 4x water temperature sensor with sleeve and 2x extension cable 3m long.

Energy efficiency index A +



BSO 01

Set consists of:	Art. No.	No.	Price
HKD 2.2 short, single glazed, side-opening door round		1	
Chamotte lining set HKD 2.2 short		1	
Upper lining HKD 2.2 short		1	
Mounting frame		1	
Modular top-mount accumulator		5	
Cast iron cover MAS ø 180 horizontal/ vertical		1	
Mounting ring for modular top-mount storage		1	
Thermal concrete cladding BSO 01		1	

Additional options

Additional ring (top ring 1), raised cladding for BSO 01 (330 mm) *	BSO1000-005		217,00
---	-------------	--	--------

* Differences of colour between the height extension ring and other components of BSK/BSO are due to manufacturing process and cannot be excluded. These colour differences are no reason for a claim.

Available variants:

Front variants			
Mounting frame, black		SET211300	6252,50

Energy efficiency index A +

BSO 01 + EAS



Set consists of:	Art. No.	No.	Price
HKD 2.2 short, single glazed, side-opening door round		1	
Chamotte lining set HKD 2.2 short		1	
Upper lining HKD 2.2 short		1	
Mounting frame		1	
Modular top-mount accumulator		5	
Cast iron cover MAS ø 180 horizontal/ vertical		1	
Mounting ring for modular top-mount storage		1	
Thermal concrete cladding BSO 01		1	
EAS (see page 165)		1	
Mounting box		1	
Door switch wiring 3 lm		1	
Thermocouple wiring 3 lm		1	
Bus wiring 3 lm		1	

Additional options			
Reduced price for EAS without display			-148,00
Additional ring (top ring 1), raised cladding for BSO 01 (330 mm) *	BSO1000-005		217,00
* Differences of colour between the height extension ring and other components of BSK/BSO are due to manufacturing process and cannot be excluded. These colour differences are no reason for a claim.			

Available variants:

Front variants			
Mounting frame, black		SET211314	7839,50

Energy efficiency index A +



Technology Sets HKD 2.2 k DR for scandinavian-CLASSIC 01 and modern ART

Set consists of:	Art. No.	No.	Price
HKD 2.2 short , single glazed, side-opening door round		1	
Chamotte lining set HKD 2.2 short		1	
Upper lining HKD 2.2 short		1	
Mounting frame		1	
Support bearing		1	
Modular top-mount accumulator		5	
Cast iron dome ø 160 mm		1	
Mounting ring for modular top-mount storage		1	

Available variants:

Front variants			
Mounting frame, black		SET213129	5768,00

Energy efficiency index A +

scandinavianCLASSIC 01	scandinavianCLASSIC 01 with crown	modernART
		

Ceramic variants: K&K Poker tile sets must be ordered directly from K&K Poker at info@kamnarstvi-bechyne.cz

Technology Sets HKD 2.2 k DR for scandinavian-CLASSIC 01 and modern ART with EAS



Set consists of:	Art. No.	No.	Price
HKD 2.2 short, single glazed, side-opening door round for EAS		1	
Chamotte lining set HKD 2.2 short		1	
Upper lining HKD 2.2 short		1	
Mounting frame		1	
Support bearing			
Modular top-mount accumulator		5	
Cast iron dome for EAS ø 160 mm		1	
Mounting ring for modular top-mount storage		1	
Mounting box		1	
EAS control unit		1	
Door switch wiring 3 lfm.		1	
Thermocouple wiring 3 lfm.		1	
Bus wiring 3 lfm.		1	
Air flap adapter ø 125 mm for direct assembly motor at device		1	

Additional options

Reduced price for EAS without display			-148,00
---------------------------------------	--	--	---------

Available variants:

Front variants			
Mounting frame, black		SET213128	7412,00

Energy efficiency index A +

scandinavianCLASSIC 01	scandinavianCLASSIC 01with crown	modernART

Ceramic variants: K&K Poker tile sets must be ordered directly from K&K Poker at info@kamnarstvi-bechyne.cz

Glazing formats

Flat glazing



BSK 42-66

BSK 06

BSK 08

BSK 04

Door dimensions height x width in cm

from
page
192

Tunnel formats



BSK 06 Tunnel

BSK 08 Tunnel

BSK 04 Tunnel

BSK 42-66 Tunnel

Door dimensions height x width in cm

from
page
200

Eck corners

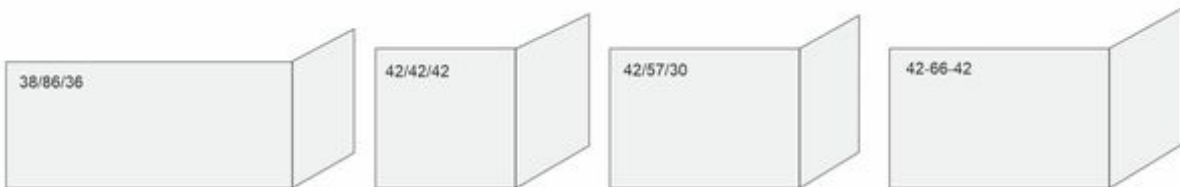

BSK 07

BSK 09

BSK 12

BSK 42-66-42

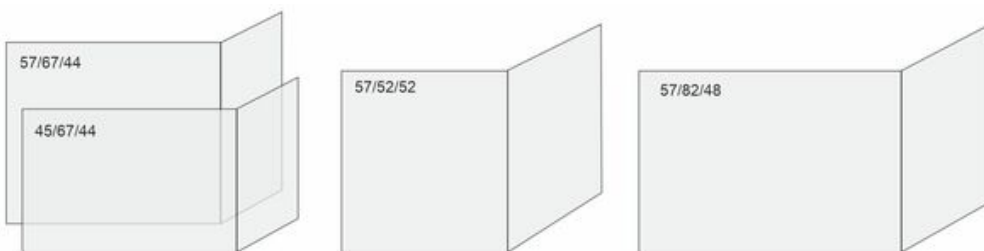

BSK 02

BSK 01

BSK 03

Door dimensions height x width x width in cm

from
page
206

Panorama formats

from
page
228

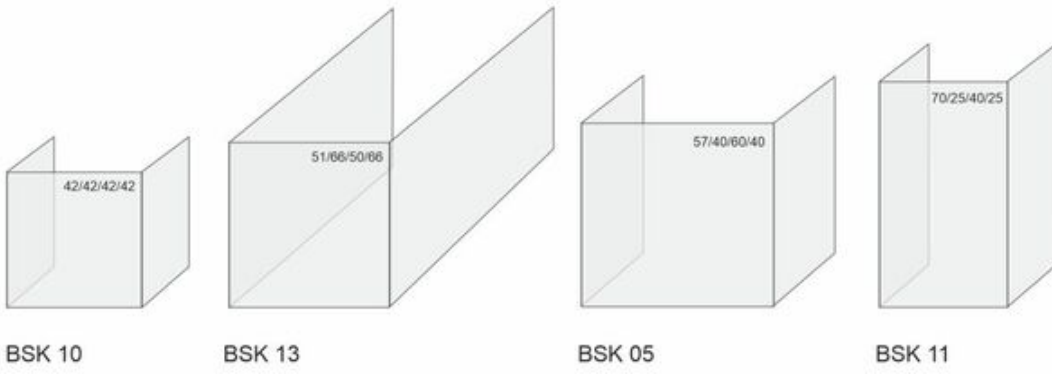

Door dimensions height x side width x front width x side width in cm

flat

Tunnel

Eck

Panorama

BSK

Door frame - mounting frame- System fireplaces

flat



Door frame



Mounting frame

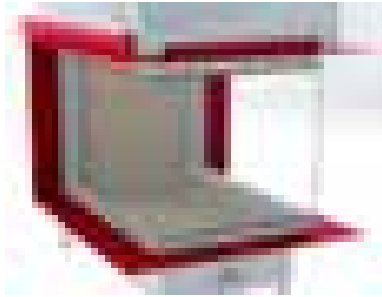

Panorama wide frame
(Fire table)

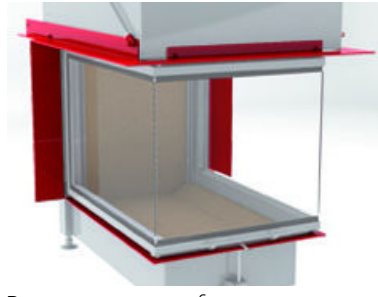

Panorama narrow frame
(Mounting bracket)

Tunnel

Supplementary equipment

- EAS** Combustion controls with potential-free relay (without additional functions) consisting of display, 1 x flush-mount box, door switch, thermocouple & bus line, each 2 m long. Preassembled EAS/EOS components, door switch, thermocouple, motor box with transmission and \varnothing 125 mm air flap, flexible hose with adjustable clamps
- EOS** Combustion control with graphic touchscreen display and additional functions (differential temperature control, Moritz's flap control) consisting of: Display with control unit, 2 x flush-mount box, door switch, thermocouple, bus and connecting line, each 2 m long, 4 x water sensors with immersion sleeve and 2x extension cable 3 m. Preassembled EOS components: door switch, thermocouple, motor box with transmission and \varnothing 125 mm air flap, flexible hose with adjustable clamps

Eck

Panorama



BSK 42-66 side-opening door

Set consists of:	Art. No.	No.	Price
BKH 5.0 Flach 42-66 DT GK FR		1	
Chamotte inner lining (FR)		1	
Cast iron heat exchanger rings		1	
Door frame		1	
Thermal concrete cladding BSK 42-66		1	
Anschlussstutzen exzentrisch ø 200 mm		1	

Additional options

Heat protection panel, rear	HK004450		150,00
Heat protection panel, rear with one side wall	HK004450-01		245,50
Heat protection panel, rear with two side walls	HK004450-02		354,00
Additional ring for raised cladding *	BSK14000-113		325,00
* Differences of colour between the height extension ring and other components of BSK/BSO are due to manufacturing process and cannot be excluded. These colour differences are no reason for a claim.			
90° bend - damper flap and cleaning ø 200 mm	S002208		227,00
90° bend - damper flap and cleaning ø 180 mm	S002198		211,00
Anschlussstutzen exzentrisch ø 180 mm	S003024		135,00
EAS (see page 165)			1561,50
Reduced price for EAS without display			-148,00
ceramic glass coated (GKB)			106,00
Cast iron inner lining (FR/Guss)			441,50
Catalyst module BKH 5.0	HK000210		871,00
Supply air connection box ø 125 mm included at EAS version	HK000135		170,50

Available variants:

Front variants			
Door frame, black		SET213323	5553,00

Energy efficiency index A +

BSK 08 Stil-Kamin side-opening door 51/67, with top-mount boiler



Set consists of:	Art. No.	No.	Price
Stil-Kamin 51/67 , side-opening door, single glazing, outlet \varnothing 200 mm		1	
Chamotte lining set Stil 51/67		1	
Top-mount boiler Stil 51/67		1	
Door frame		1	
Thermal concrete cladding BSK 08		1	

Additional options

Set heat-protective panel	BSK8000-138		104,00
Additional ring for raised cladding BSK 08 *	BSK8000-006		330,50
* Differences of colour between the height extension ring and other components of BSK/BSO are due to manufacturing process and cannot be excluded. These colour differences are no reason for a claim.			
Damper flap \varnothing 200 mm with stainless steel handle	02460+10275		292,50
Conversion kit right hinge door	02380		133,00
Double glazing			289,00
Smoke pipe adapter for horizontal outlet	BSK7000-129		405,50
EOS (see page 165)			2829,00
EAS (see page 165)			1561,50
Reduced price for EAS without display			-148,00
Air flap adapter \varnothing 125 mm for direct assembly motor at device	N003156		24,00
Socket blend stainless steel	BSK8000-126		192,00

Available variants:

Front variants			
Door frame, black		SET210580	7502,00

at lateral outlet an additional ring (BSK8000-006) and the smoke pipe adapter (BSK7000-129) are required

Energy efficiency index A +



BSK 08 Stil-Kamin lifting door 51/67, with top-mount boiler

Set consists of:	Art. No.	No.	Price
Stil-Kamin 51/67 , lifting door, single glazing, outlet \varnothing 200 mm		1	
Chamotte lining set Stil 51/67		1	
Top-mount boiler Stil 51/67		1	
Mounting frame		1	
Thermal concrete cladding BSK 08		1	

Additional options			
Set heat-protective panel	BSK8000-138		104,00
Additional ring for raised cladding BSK 08 *	BSK8000-006		330,50
* Differences of colour between the height extension ring and other components of BSK/BSO are due to manufacturing process and cannot be excluded. These colour differences are no reason for a claim.			
Damper flap \varnothing 200 mm with stainless steel handle	02460+10275		292,50
Double glazing			289,00
Counterweights for non-self closing door	49097		46,50
Smoke pipe adapter for horizontal outlet	BSK7000-129		405,50
EOS (see page 165)			2829,00
EAS (see page 165)			1561,50
Reduced price for EAS without display			-148,00
Air flap adapter \varnothing 125 mm for direct assembly motor at device	N003156		24,00
Socket blend stainless steel	BSK8000-126		192,00

Available variants:

Front variants			
Mounting frame, black		SET210582	8355,50

at lateral outlet an additional ring (BSK8000-006) and the smoke pipe adapter (BSK7000-129) are required

Energy efficiency index A +

BSK 08 Stil-Kamin side-opening door 51/67, hot air convection top



Set consists of:	Art. No.	No.	Price
Stil-Kamin 51/67 , side-opening door, single glazing, outlet \varnothing 250 mm		1	
Chamotte lining set Stil 51/67		1	
hot air convection top Stil 51/67		1	
Door frame		1	
Thermal concrete cladding BSK 08		1	

Additional options

Protective panels for BSK 08 back wall	BSK8000-123		245,00
Heat protective panels for BSK 08 side wall	BSK8000-121		186,00
Additional ring for raised cladding BSK 08 *	BSK8000-006		330,50
* Differences of colour between the height extension ring and other components of BSK/BSO are due to manufacturing process and cannot be excluded. These colour differences are no reason for a claim.			
Damper flap \varnothing 250 mm with stainless steel handle	02461+10275		303,00
Conversion kit right hinge door	02380		133,00
Double glazing			289,00
Exchange connecting piece \varnothing 180 mm	I019448		61,00
Exchange connecting piece \varnothing 200 mm	I019449		61,00
Smoke pipe adapter for horizontal outlet	I019490		299,00
EAS (see page 165)			1561,50
Reduced price for EAS without display			-148,00
Air flap adapter \varnothing 125 mm for direct assembly motor at device	N003156		24,00
Socket blend stainless steel	BSK8000-126		192,00

Available variants:

Front variants			
Door frame, black		SET210571	5670,00

at rear and lateral outlet the smoke pipe adapter (I019490) is required

Energy efficiency class A



BSK 08 Stil-Kamin lifting door 51/67, hot air convection top

Set consists of:	Art. No.	No.	Price
Stil-Kamin 51/67 , lifting door, single glazing, outlet \varnothing 250 mm		1	
Chamotte lining set Stil 51/67		1	
hot air convection top Stil 51/67		1	
Mounting frame		1	
Thermal concrete cladding BSK 08		1	

Additional options			
Protective panels for BSK 08 back wall	BSK8000-123		245,00
Heat protective panels for BSK 08 side wall	BSK8000-121		186,00
Additional ring for raised cladding BSK 08 *	BSK8000-006		330,50
* Differences of colour between the height extension ring and other components of BSK/BSO are due to manufacturing process and cannot be excluded. These colour differences are no reason for a claim.			
Damper flap \varnothing 250 mm with stainless steel handle	02461+10275		303,00
Double glazing			289,00
Counterweights for non-self closing door	49097		46,50
Exchange connecting piece \varnothing 180 mm	I019448		61,00
Exchange connecting piece \varnothing 200 mm	I019449		61,00
Smoke pipe adapter for horizontal outlet	I019490		299,00
EAS (see page 165)			1561,50
Reduced price for EAS without display			-148,00
Air flap adapter \varnothing 125 mm for direct assembly motor at device	N003156		24,00
Socket blend stainless steel	BSK8000-126		192,00

Available variants:

Front variants			
Mounting frame, black		SET210573	6523,50

at rear and lateral outlet the smoke pipe adapter (I019490) is required

Energy efficiency class A



BSK 04 Stil-Kamin 62/76 lifting door

Set consists of:	Art. No.	No.	Price
Stil-Kamin 62/76 , lifting door, single glazing, outlet ø 200 mm		1	
Brick plates 62/76		1	
Mounting frame		1	
Thermal concrete cladding BSK 04		1	
Cast iron hot air hood ø 200 mm		1	

Additional options			
Heat protective panels for BSK 04 back wall	BSK4000-118		180,00
Heat protective panels for BSK 04 side wall	BSK4000-119		144,00
Additional ring for raised cladding BSK 04 *	BSK4000-009		352,00
* Differences of colour between the height extension ring and other components of BSK/BSO are due to manufacturing process and cannot be excluded. These colour differences are no reason for a claim.			
Damper flap ø 200 mm with stainless steel handle	02460+10275		292,50
Double glazing			417,00
Counterweights for non-self closing door	49097		46,50
Spare connecting piece ø 250 mm	R014022-02		0,00
Spare connecting piece ø 180 mm	R014022-03		0,00
EAS (see page 165)			1561,50
Reduced price for EAS without display			-148,00
Socket blend stainless steel	BSK4000-122		192,00

Available variants:

Front variants			
Mounting frame, black 50 mm		SET213040	7613,00

Energy efficiency class A



BSK 06 AK 45/101 lifting door, hot air convection top

Set consists of:	Art. No.	No.	Price
Architektur-Kamin 45/101 , lifting door, single glazing, outlet \varnothing 250 mm		1	
Chamotte lining set, bright, for AK 45/101		1	
Mounting frame		1	
Thermal concrete cladding BSK 06		1	
hot air convection top BSK 06		1	

Additional options			
Heat protective panels for BSK 06 back wall	BSK6000-135		315,00
Heat protective panels for BSK 06 side wall	BSK6000-136		144,00
Additional ring for raised cladding BSK 06 *	BSK6000-009		372,00
* Differences of colour between the height extension ring and other components of BSK/BSO are due to manufacturing process and cannot be excluded. These colour differences are no reason for a claim.			
Damper flap \varnothing 250 mm with stainless steel handle	02461+10275		303,00
Double glazing			405,00
Counterweights for non-self closing door	49097		46,50
Exchange connecting piece \varnothing 180 mm	I019448		61,00
Exchange connecting piece \varnothing 200 mm	I019449		61,00
Smoke pipe adapter for horizontal outlet	I019490		299,00
EAS (see page 165)			1561,50
Reduced price for EAS without display			-148,00
Air flap adapter \varnothing 125 mm for direct assembly motor at device	N003156		24,00

Available variants:

Front variants			
Mounting frame, black 50 mm		SET207439	7875,50

Energy efficiency class A

BSK 06 AK 45/101 lifting door, with top-mount boiler



Set consists of:	Art. No.	No.	Price
Architektur-Kamin 45/101 , lifting door, single glazing, outlet \varnothing 250 mm		1	
Chamotte lining set, bright, for AK 45/101		1	
Top-mount boiler AK 45/101		1	
Mounting frame		1	
Thermal concrete cladding BSK 06		1	

Additional options			
EOS (see page 165)			2829,00
EAS (see page 165)			1561,50
Reduced price for EAS without display			-148,00
Air flap adapter \varnothing 125 mm for direct assembly motor at device	N003156		24,00
Set- heat protective panel 1x rear - 1x lateral	BSK6000-140		102,50
Additional ring for raised cladding BSK 06 *	BSK6000-009		372,00
* Differences of colour between the height extension ring and other components of BSK/BSO are due to manufacturing process and cannot be excluded. These colour differences are no reason for a claim.			
Damper flap \varnothing 250 mm with stainless steel handle	02461+10275		303,00
Double glazing			405,00
Counterweights for non-self closing door	49097		46,50
Smoke pipe adapter for horizontal outlet	I019490		299,00

Available variants:

Front variants			
Mounting frame, black 50 mm		SET205293	10140,50

Energy efficiency index A +



BSK Tunnel 42-66, DT/DT

Set consists of:	Art. No.	No.	Price
BKH 5.0 Tunnel 42-66 DT/DT GK FR		1	
Chamotte inner lining (FR)		1	
Cast iron heat exchanger rings		1	
Door frame		2	
Thermal concrete cladding BSK Tunnel 42-66		1	
Anschlussstutzen exzentrisch ø 200 mm		1	

Additional options

Heat protection panel for one side	HK014251		121,50
Additional ring for raised cladding *	BSK14000-113		325,00
* Differences of colour between the height extension ring and other components of BSK/BSO are due to manufacturing process and cannot be excluded. These colour differences are no reason for a claim.			
90° bend - damper flap and cleaning ø 200 mm	S002208		227,00
90° bend - damper flap and cleaning ø 180 mm	S002198		211,00
Anschlussstutzen exzentrisch ø 180 mm	S003024		135,00
EAS (see page 165)			1561,50
Reduced price for EAS without display			-148,00
ceramic glass coated (GKB)			212,00
Cast iron inner lining (FR/Guss)			259,00
Catalyst module BKH 5.0	HK000210		871,00
Supply air connection box ø 125 mm included at EAS version	N0003156		170,50

Available variants:

Front variants			
Door frame, black		SET213324	7406,00

Energy efficiency index A +

BSK 08 Stil-Kamin Tunnel 51/67, ST/DT, with top-mount boiler



Set consists of:	Art. No.	No.	Price
Stil-Kamin Tunnel 51/67 , lifting door/side opening door, single glazing, outlet ø 200 mm		1	
Chamotte lining set Stil 51/67		1	
Top-mount boiler Stil 51/67		1	
Door frame DT		1	
Mounting frame ST		1	
Thermal concrete cladding BSK 08		1	

Additional options

Additional ring for raised cladding BSK 08 *	BSK8000-006		330,50
* Differences of colour between the height extension ring and other components of BSK/BSO are due to manufacturing process and cannot be excluded. These colour differences are no reason for a claim.			
Damper flap ø 200 mm with stainless steel handle	02460+10275		292,50
Revision handle	02426		130,00
Double glazing (also one side only available on request)			578,00
Counterweights for non-self closing door	49097		46,50
Smoke pipe adapter for horizontal outlet	BSK7000-129		405,50
EOS (see page 165)			2974,00
EAS (see page 165)			1706,50
Reduced price for EAS without display			-148,00
Air flap adapter ø 125 mm for direct assembly motor at device	N003156		24,00
Socket blend stainless steel	BSK8000-126		192,00

Available variants:

Front variants			
Door frame or mounting frame 50 mm black		SET210586	10883,00

at lateral outlet an additional ring (BSK8000-006) and the smoke pipe adapter (BSK7000-129) are required

Energy efficiency index A +

BSK 08 Stil-Kamin Tunnel 51/67, ST/DT, hot air convection top



flat

Tunnel

BSK

Eck

Panorama

Set consists of:	Art. No.	No.	Price
Stil-Kamin Tunnel 51/67 , lifting door/side opening door, single glazing, outlet \varnothing 250 mm		1	
Chamotte lining set Stil 51/67		1	
hot air convection top 51/67		1	
Door frame DT		1	
Mounting frame ST		1	
Thermal concrete cladding BSK 08		1	

Additional options			
Heat protective panels for BSK 08 side wall	BSK8000-121		186,00
Additional ring for raised cladding BSK 08 *	BSK8000-006		330,50
* Differences of colour between the height extension ring and other components of BSK/BSO are due to manufacturing process and cannot be excluded. These colour differences are no reason for a claim.			
Damper flap \varnothing 250 mm with stainless steel handle	02461+10275		303,00
Revision handle	02426		130,00
Double glazing (also one side only available on request)			578,00
Counterweights for non-self closing door	49097		46,50
Exchange connecting piece \varnothing 180 mm	I019448		61,00
Exchange connecting piece \varnothing 200 mm	I019449		61,00
Smoke pipe adapter for horizontal outlet	I019490		299,00
EAS (see page 165)			1706,50
Reduced price for EAS without display			-148,00
Air flap adapter \varnothing 125 mm for direct assembly motor at device	N003156		24,00
Socket blend stainless steel	BSK8000-126		192,00

Available variants:

Front variants			
Door frame or mounting frame, 50 mm black		SET210578	9051,00

at rear and lateral outlet the smoke pipe adapter (I019490) is required

Energy efficiency class A



BSK 04

Set consists of:	Art. No.	No.	Price
Stil-Kamin Tunnel 62/76 , lifting/tilting door, single glazing, outlet ø 250 mm		1	
Chamotte lining set 62/76 Tunnel		1	
Mounting frame		2	
Thermal concrete cladding BSK 04		1	

Additional options			
Heat protective panels for BSK 04 side wall	BSK4000-119		144,00
Additional ring for raised cladding BSK 04 *	BSK4000-009		352,00
* Differences of colour between the height extension ring and other components of BSK/BSO are due to manufacturing process and cannot be excluded. These colour differences are no reason for a claim.			
Damper flap ø 250 mm with stainless steel handle	02461+10275		303,00
Double glazing (also one side only available on request)			834,00
Counterweights for non-self closing door	49097		46,50
Version with 2 lifting doors upon request			
Socket blend stainless steel	BSK4000-122		192,00

Available variants:

Front variants			
Mounting frame, black 50 mm		SET207435	9912,00

Energy efficiency class A



BSK 06 AK 45/101 lifting/tilting door, hot air convection top

Set consists of:	Art. No.	No.	Price
AK 45/101 , lifting/tilting door, single glazing, outlet ø 250 mm		1	
Chamotte lining set, bright, for AK 45/101 Tunnel		1	
hot air convection top AK 45/101		1	
Mounting frame		2	
Thermal concrete cladding BSK 06		1	

Additional options			
Heat protective panels for BSK 06 side wall	BSK6000-136		144,00
Additional ring for raised cladding BSK 06 *	BSK6000-009		372,00
* Differences of colour between the height extension ring and other components of BSK/BSO are due to manufacturing process and cannot be excluded. These colour differences are no reason for a claim.			
Damper flap ø 250 mm with stainless steel handle	02461+10275		303,00
Double glazing (also one side only available on request)			810,00
Counterweights for non-self closing door	49097		46,50
Exchange connecting piece ø 180 mm	I019448		61,00
Exchange connecting piece ø 200 mm	I019449		61,00
Smoke pipe adapter for horizontal outlet	I019490		299,00
EAS (see page 165)			1561,50
Reduced price for EAS without display			-148,00
Air flap adapter ø 125 mm for direct assembly motor at device	N003156		24,00
Lifting doors on both sides available upon request			

Available variants:

Front variants			
Mounting frame, black, 50 mm		SET207443	10216,50

Energy efficiency class A

BSK 06 AK 45/101 lifting/tilting door, with top-mount boiler



Set consists of:	Art. No.	No.	Price
AK 45/101, lifting/tilting door, single glazing, outlet ø 250 mm		1	
Chamotte lining set, bright, for AK 45/101 Tunnel		1	
Top-mount boiler AK 45/101		1	
Mounting frame		2	
Thermal concrete cladding BSK 06		1	

Additional options			
EOS (see page 165)			2829,00
EAS (see page 165)			1561,50
Reduced price for EAS without display			-148,00
Air flap adapter ø 125 mm for direct assembly motor at device	N003156		24,00
Additional ring for raised cladding BSK 06 *	BSK6000-009		372,00
* Differences of colour between the height extension ring and other components of BSK/BSO are due to manufacturing process and cannot be excluded. These colour differences are no reason for a claim.			
Damper flap ø 250 mm with stainless steel handle	02461+10275		303,00
Counterweights for non-self closing door	49097		46,50
Double glazing (also one side only available on request)			810,00
Smoke pipe adapter for horizontal outlet	I019490		299,00
Lifting doors on both sides available upon request			

Available variants:

Front variants			
Mounting frame, black 50 mm		SET208980	12481,50

Energy efficiency index A +



BSK Eck 42-66-42 DTL

Set consists of:	Art. No.	No.	Price
BKH 5.0 Eck 42-66-42 DTL, two-piece ceramic glass		1	
Chamotte inner lining (FR)		1	
Cast iron heat exchanger rings		1	
Door frame		1	
Thermal concrete cladding BSK Eck		1	
Anschlussstutzen exzentrisch ø 200 mm		1	

Additional options			
Heat protection panel with one side wall	HK021450		270,00
Additional ring for raised cladding *	BSK14000-113		325,00
* Differences of colour between the height extension ring and other components of BSK/BSO are due to manufacturing process and cannot be excluded. These colour differences are no reason for a claim.			
90° bend - damper flap and cleaning ø 200 mm	S002208		227,00
90° bend - damper flap and cleaning ø 180 mm	S002198		211,00
Anschlussstutzen exzentrisch ø 180 mm	S003024		135,00
EAS (see page 165)			1561,50
Reduced price for EAS without display			-148,00
ceramic glass coated (GKB)			250,00
Cast iron inner lining (FR/Guss)			310,00
Catalyst module BKH 5.0	HK000210		871,00
Supply air connection box ø 125 mm included at EAS version	HK000135		170,50

Available variants:

Front variants			
Door frame, black		SET213325	6542,00

Energy efficiency index A +

BSK Eck 42-66-42 DTR



Set consists of:	Art. No.	No.	Price
BKH 5.0 Eck 42-66-42 DTR, two-piece ceramic glass		1	
Chamotte inner lining (FR)		1	
Cast iron heat exchanger rings		1	
Door frame		1	
Thermal concrete cladding BSK Eck		1	
Anschlusstutzen exzentrisch ø 200 mm		1	

Additional options			
Heat protection panel with one side wall	HK021450		270,00
Additional ring for raised cladding *	BSK14000-113		325,00
* Differences of colour between the height extension ring and other components of BSK/BSO are due to manufacturing process and cannot be excluded. These colour differences are no reason for a claim.			
90° bend - damper flap and cleaning ø 200 mm	S002208		227,00
90° bend - damper flap and cleaning ø 180 mm	S002198		211,00
Anschlusstutzen exzentrisch ø 180 mm	S003024		135,00
EAS (see page 165)			1561,50
Reduced price for EAS without display			-148,00
ceramic glass coated (GKB)			250,00
Cast iron inner lining (FR/Guss)			310,00
Catalyst module BKH 5.0	HK000210		871,00
Supply air connection box ø 125 mm included at EAS version	HK000135		170,50

Available variants:

Front variants			
Door frame, black		SET213326	6542,00

Energy efficiency index A +



BSK 09 with top-mount heat exchanger

Set consists of:	Art. No.	No.	Price
Eck 42/42/42 , side-opening door, single glazing two-piece ceramic glass		1	
Chamotte lining set Eck 42/42/42		1	
Cast iron hot air hood ø 200 mm		1	
Door frame		1	
Thermal concrete cladding BSK 09		1	

Additional options

Heat protective panels for BSK 09 side & back walls	BSK9000-128		200,50
Additional ring for raised cladding BSK 09 *	BSK9000-008		232,50
* Differences of colour between the height extension ring and other components of BSK/BSO are due to manufacturing process and cannot be excluded. These colour differences are no reason for a claim.			
Conversion kit right hinge door	02380		133,00
EAS (see page 165)			1561,50
Reduced price for EAS without display			-148,00
Air flap adapter ø 125 mm for direct assembly motor at device	N003156		24,00
Socket blend stainless steel	BSK9000-131		167,00

Available variants:



Front variants			
Door frame, black		SET213041	5224,50

Energy efficiency index A +

BSK 09 with top- mount accumulator



Set consists of:	Art. No.	No.	Price
Eck 42/42/42, side-opening door, single glazing two-piece ceramic glass		1	
Chamotte lining set Eck 42/42/42		1	
Modular top-mount accumulator		4	
Cast iron cover MAS ø 180 horizontal/ vertical		1	
Mounting ring for modular top-mount storage		1	
Door frame		1	
Thermal concrete cladding BSK 09		1	

Additional options			
Heat protective panels for BSK 09 side & back walls	BSK9000-128		200,50
Additional ring for raised cladding BSK 09 *	BSK9000-008		232,50
* Differences of colour between the height extension ring and other components of BSK/BSO are due to manufacturing process and cannot be excluded. These colour differences are no reason for a claim.			
Conversion kit right hinge door	02380		133,00
EAS (see page 165)			1561,50
Reduced price for EAS without display			-148,00
Air flap adapter ø 125 mm for direct assembly motor at device	N003156		24,00
Socket blend stainless steel	BSK9000-131		167,00

Available variants:



Front variants			
Door frame, black		SET211402	6286,50

Energy efficiency index A +



BSK 01 side-opening door

Set consists of:	Art. No.	No.	Price
Eck 57/52/52 , side-opening door, single glazing two-piece ceramic glass		1	
Chamotte lining set Eck 57/52/52		1	
Cast iron hot air hood ø 200 mm		1	
Door frame		1	
Thermal concrete cladding BSK 01		1	

Additional options

Heat protective panels for BSK 01 side & back walls	BSK1000-143		233,50
Damper flap ø 200 mm with stainless steel handle	02460+10275		292,50
Additional ring for raised cladding BSK 01 *	BSK1000-009		237,50
* Differences of colour between the height extension ring and other components of BSK/BSO are due to manufacturing process and cannot be excluded. These colour differences are no reason for a claim.			
Conversion kit right hinge door	02380		133,00
Spare connecting piece ø 250 mm	R014022-02		0,00
Spare connecting piece ø 180 mm	R014022-03		0,00
EAS (see page 165)			1561,50
Reduced price for EAS without display			-148,00
Air flap adapter ø 125 mm for direct assembly motor at device	N003156		24,00
Socket blend stainless steel	BSK1000-153		167,00

Available variants:

Front variants			
Door frame, black		SET213042	5654,50

Energy efficiency class A



BSK 01 lifting door

Set consists of:	Art. No.	No.	Price
Eck 57/52/52, lifting door, single glazing two-piece ceramic glass		1	
Chamotte lining set Eck 57/52/52		1	
Cast iron hot air hood ø 200 mm		1	
Mounting frame		1	
Thermal concrete cladding BSK 01		1	

Additional options			
Heat protective panels for BSK 01 side & back walls	BSK1000-143		233,50
Counterweights for non-self closing door	49097		46,50
Damper flap ø 200 mm with stainless steel handle	02460+10275		292,50
Additional ring for raised cladding BSK 01 *	BSK1000-009		237,50
* Differences of colour between the height extension ring and other components of BSK/BSO are due to manufacturing process and cannot be excluded. These colour differences are no reason for a claim.			
Spare connecting piece ø 250 mm	R014022-02		0,00
Spare connecting piece ø 180 mm	R014022-03		0,00
EAS (see page 165)			1561,50
Reduced price for EAS without display			-148,00
Air flap adapter ø 125 mm for direct assembly motor at device	N003156		24,00
Socket blend stainless steel	BSK1000-153		167,00

Available variants:

Front variants			
Mounting frame, black 50 mm		SET213043	6642,00

Energy efficiency class A

BSK 02 Corner fireplace waterbearing 45/67/44 left side, lifting door



Set consists of:	Art. No.	No.	Price
Corner fireplace waterbearing 45/67/44, left side, lifting door two-piece ceramic glass, outlet ø 180 mm		1	
Chamotte lining set, bright, for Eck-Kamin 45/67/44 l/r		1	
Thermal concrete cladding BSK 02		1	
ISO upper lining		1	

Additional options			
EOS (see page 165)			2829,00
EAS (see page 165)			1561,50
Reduced price for EAS without display			-148,00
Air flap adapter ø 125 mm for direct assembly motor at device	N003156		24,00
Counterweights for non-self closing door	49097		46,50
Set- heat protective panel 1x rear - 1x lateral	BSK2000-208		38,50
Additional ring for raised cladding BSK 02 *	BSK2000-007		305,00
* Differences of colour between the height extension ring and other components of BSK/BSO are due to manufacturing process and cannot be excluded. These colour differences are no reason for a claim.			
Conversion kit for cleaning on top including push-in handle	BSK2000-201		209,50
Socket blend stainless steel	BSK2000-162		167,00

Available variants:

Front variants			
Mounting frame, black 50 mm		SET212994	9479,00

Energy efficiency index A +

flat

Tunnel

BSK

Eck

Panorama

BSK 02 Corner fireplace waterbearing 45/67/44 right side, lifting door



Set consists of:	Art. No.	No.	Price
Corner fireplace waterbearing 45/67/44, right side, lifting door two-piece ceramic glass, outlet ø 180 mm		1	
Chamotte lining set, bright, for Eck-Kamin 45/67/44 l/r		1	
Thermal concrete cladding BSK 02		1	
ISO upper lining		1	

Additional options			
EOS (see page 165)			2829,00
EAS (see page 165)			1561,50
Reduced price for EAS without display			-148,00
Air flap adapter ø 125 mm for direct assembly motor at device	N003156		24,00
Counterweights for non-self closing door	49097		46,50
Set- heat protective panel 1x rear - 1x lateral	BSK2000-208		38,50
Additional ring for raised cladding BSK 02 *	BSK2000-007		305,00
* Differences of colour between the height extension ring and other components of BSK/BSO are due to manufacturing process and cannot be excluded. These colour differences are no reason for a claim.			
Conversion kit for cleaning on top including push-in handle	BSK2000-201		209,50
Socket blend stainless steel	BSK2000-162		167,00

Available variants:

Front variants			
Mounting frame, black 50 mm		SET212996	9479,00

Energy efficiency index A +



BSK 02 Eck 45/67/44 left side, lifting door

Set consists of:	Art. No.	No.	Price
Eck 45/67/44, left side , lifting door, single glazing two-piece ceramic glass		1	
Chamotte lining set Eck 45/67/44 l		1	
Cast iron hot air hood ø 200 mm		1	
Thermal concrete cladding BSK 02		1	

Additional options			
Heat protective panels for BSK 02 side & back walls	BSK2000-125		270,00
Damper flap ø 200 mm with stainless steel handle	02460+10275		292,50
Spare connecting piece ø 250 mm	R014022-02		0,00
Spare connecting piece ø 180 mm	R014022-03		0,00
Counterweights for non-self closing door	49097		46,50
Additional ring for raised cladding BSK 02 *	BSK2000-007		305,00
* Differences of colour between the height extension ring and other components of BSK/BSO are due to manufacturing process and cannot be excluded. These colour differences are no reason for a claim.			
EAS (see page 165)			1561,50
Reduced price for EAS without display			-148,00
Air flap adapter ø 125 mm for direct assembly motor at device	N003156		24,00
Socket blend stainless steel	BSK2000-162		167,00

Available variants:

Front variants			
Mounting frame, black 50 mm		SET213044	7007,50

Energy efficiency class A



BSK 02 Eck 45/67/44 right side, lifting door

Set consists of:	Art. No.	No.	Price
Eck 45/67/44, right side , lifting door, single glazing two-piece ceramic glass		1	
Chamotte lining set Eck 45/67/44 r		1	
Cast iron hot air hood ø 200 mm		1	
Thermal concrete cladding BSK 02		1	

Additional options			
Heat protective panels for BSK 02 side & back walls	BSK2000-125		270,00
Damper flap ø 200 mm with stainless steel handle	02460+10275		292,50
Counterweights for non-self closing door	49097		46,50
Spare connecting piece ø 250 mm	R014022-02		0,00
Spare connecting piece ø 180 mm	R014022-03		0,00
Additional ring for raised cladding BSK 02 *	BSK2000-007		305,00
* Differences of colour between the height extension ring and other components of BSK/BSO are due to manufacturing process and cannot be excluded. These colour differences are no reason for a claim.			
EAS (see page 165)			1561,50
Reduced price for EAS without display			-148,00
Air flap adapter ø 125 mm for direct assembly motor at device	N003156		24,00
Socket blend stainless steel	BSK2000-162		167,00

Available variants:

Front variants			
Mounting frame, black 50 mm		SET213045	7007,50

Energy efficiency class A



BSK 02 Eck 57/67/44 left side, lifting door

Set consists of:	Art. No.	No.	Price
Eck 57/67/44, left side , lifting door, single glazing two-piece ceramic glass		1	
Chamotte lining set Eck 57/67/44 l		1	
Cast iron hot air hood ø 200 mm		1	
Thermal concrete cladding BSK 02		1	

Additional options			
Heat protective panels for BSK 02 side & back walls	BSK2000-125		270,00
Damper flap ø 200 mm with stainless steel handle	02460+10275		292,50
Counterweights for non-self closing door	49097		46,50
Spare connecting piece ø 250 mm	R014022-02		0,00
Spare connecting piece ø 180 mm	R014022-03		0,00
Additional ring for raised cladding BSK 02 *	BSK2000-007		305,00
* Differences of colour between the height extension ring and other components of BSK/BSO are due to manufacturing process and cannot be excluded. These colour differences are no reason for a claim.			
EAS (see page 165)			1561,50
Reduced price for EAS without display			-148,00
Air flap adapter ø 125 mm for direct assembly motor at device	N003156		24,00
Socket blend stainless steel	BSK2000-162		167,00

Available variants:

Front variants			
Mounting frame, black 50 mm		SET213046	7153,50

Energy efficiency class A

flat

Tunnel

BSK

Eck

Panorama



BSK 02 Eck 57/67/44 right side, lifting door

Set consists of:	Art. No.	No.	Price
Eck 57/67/44, right side , lifting door, single glazing two-piece ceramic glass		1	
Chamotte lining set Eck 57/67/44 r		1	
Cast iron hot air hood ø 200 mm		1	
Thermal concrete cladding BSK 02		1	

Additional options			
Heat protective panels for BSK 02 side & back walls	BSK2000-125		270,00
Damper flap ø 200 mm with stainless steel handle	02460+10275		292,50
Counterweights for non-self closing door	49097		46,50
Spare connecting piece ø 250 mm	R014022-02		0,00
Spare connecting piece ø 180 mm	R014022-03		0,00
Additional ring for raised cladding BSK 02 *	BSK2000-007		305,00
* Differences of colour between the height extension ring and other components of BSK/BSO are due to manufacturing process and cannot be excluded. These colour differences are no reason for a claim.			
EAS (see page 165)			1561,50
Reduced price for EAS without display			-148,00
Air flap adapter ø 125 mm for direct assembly motor at device	N003156		24,00
Socket blend stainless steel	BSK2000-162		167,00

Available variants:

Front variants			
Mounting frame, black 50 mm		SET213047	7153,50

Energy efficiency class A



BSK 03 Eck left side, lifting door

Set consists of:	Art. No.	No.	Price
Eck 57/82/48, left side , lifting door, single glazing two-piece ceramic glass		1	
Chamotte lining set Eck 57/82/48 l		1	
Cast iron hot air hood ø 200 mm		1	
Thermal concrete cladding BSK 03		1	

Additional options			
Heat protective panels for BSK 02 side & back walls	BSK3000-129		323,50
Damper flap ø 200 mm with stainless steel handle	02460+10275		292,50
Counterweights for non-self closing door	49097		46,50
Spare connecting piece ø 250 mm	R014022-02		0,00
Spare connecting piece ø 180 mm	R014022-03		0,00
Additional ring for raised cladding BSK 03 *	BSK3000-007		312,00
* Differences of colour between the height extension ring and other components of BSK/BSO are due to manufacturing process and cannot be excluded. These colour differences are no reason for a claim.			
EAS (see page 165)			1561,50
Reduced price for EAS without display			-148,00
Air flap adapter ø 125 mm for direct assembly motor at device	N003156		24,00
Socket blend stainless steel	BSK3000-142		192,00

Available variants:

Front variants			
Mounting frame, black 50 mm		SET213048	7986,00

Energy efficiency class A



BSK 03 Eck right side, lifting door

Set consists of:	Art. No.	No.	Price
Eck 57/82/48, right side , lifting door, single glazing two-piece ceramic glass		1	
Chamotte lining set Eck 57/82/48 r		1	
Cast iron hot air hood ø 200 mm		1	
Thermal concrete cladding BSK 03		1	

Additional options			
Heat protective panels for BSK 02 side & back walls	BSK3000-129		323,50
Damper flap ø 200 mm with stainless steel handle	02460+10275		292,50
Counterweights for non-self closing door	49097		46,50
Spare connecting piece ø 250 mm	R014022-02		0,00
Spare connecting piece ø 180 mm	R014022-03		0,00
Additional ring for raised cladding BSK 03 *	BSK3000-007		312,00
* Differences of colour between the height extension ring and other components of BSK/BSO are due to manufacturing process and cannot be excluded. These colour differences are no reason for a claim.			
EAS (see page 165)			1561,50
Reduced price for EAS without display			-148,00
Air flap adapter ø 125 mm for direct assembly motor at device	N003156		24,00
Socket blend stainless steel	BSK3000-142		192,00

Available variants:

Front variants			
Mounting frame, black 50 mm		SET213049	7986,00

Energy efficiency class A



BSK 07 low left side

Set consists of:	Art. No.	No.	Price
Eck 38/86/36, left side , lifting door, single glazing two-piece ceramic glass, outlet ø 200 mm		1	
Chamotte lining set Eck 38/86/36		1	
Thermal concrete cladding BSK 07		1	

Additional options			
Heat protective panels for BSK 07 side & back walls	BSK7000-131		288,00
Damper flap ø 200 mm with stainless steel handle	02460+10275		292,50
Smoke pipe adapter for horizontal/vertical outlet Spare connecting piece not possible	BSK7000-129		405,50
Counterweights for non-self closing door	49097		46,50
Additional ring for raised cladding BSK 07 *	BSK7000-007		352,00
* Differences of colour between the height extension ring and other components of BSK/BSO are due to manufacturing process and cannot be excluded. These colour differences are no reason for a claim.			
EAS (see page 165)			1561,50
Reduced price for EAS without display			-148,00
Air flap adapter ø 125 mm for direct assembly motor at device	N003156		24,00
Socket blend stainless steel	BSK7000-137		167,00

Available variants:

Front variants			
Mounting frame, black 50 mm		SET211196	7380,00

BSK 07 low right side



Set consists of:	Art. No.	No.	Price
Eck 38/86/36, right side , lifting door, single glazing two-piece ceramic glass, outlet ø 200 mm		1	
Chamotte lining set Eck 38/86/36		1	
Thermal concrete cladding BSK 07		1	

Additional options			
Heat protective panels for BSK 07 side & back walls	BSK7000-131		288,00
Damper flap ø 200 mm with stainless steel handle	02460+10275		292,50
Smoke pipe adapter for horizontal/vertical outlet Spare connecting piece not possible	BSK7000-129		405,50
Counterweights for non-self closing door	49097		46,50
Additional ring for raised cladding BSK 07 *	BSK7000-007		352,00
* Differences of colour between the height extension ring and other components of BSK/BSO are due to manufacturing process and cannot be excluded. These colour differences are no reason for a claim.			
EAS (see page 165)			1561,50
Reduced price for EAS without display			-148,00
Air flap adapter ø 125 mm for direct assembly motor at device	N003156		24,00
Socket blend stainless steel	BSK7000-137		167,00

Available variants:

Front variants			
Mounting frame, black 50 mm		SET211198	7380,00

Energy efficiency class A



BSK 07 high left side

Set consists of:	Art. No.	No.	Price
Eck 38/86/36, left side , lifting door, single glazing two-piece ceramic glass, outlet ø 200 mm		1	
Chamotte lining set Eck 38/86/36		1	
Support bearing BSK 07		1	
Thermal concrete cladding BSK 07		1	

Additional options			
Heat protective panels for BSK 07 side & back walls	BSK7000-131		288,00
Damper flap ø 200 mm with stainless steel handle	02460+10275		292,50
Smoke pipe adapter for horizontal/vertical outlet Spare connecting piece not possible	BSK7000-129		405,50
Counterweights for non-self closing door	49097		46,50
Additional ring for raised cladding BSK 07 *	BSK7000-007		352,00
* Differences of colour between the height extension ring and other components of BSK/BSO are due to manufacturing process and cannot be excluded. These colour differences are no reason for a claim.			
EAS (see page 165)			1561,50
Reduced price for EAS without display			-148,00
Socket blend stainless steel	BSK7000-137		167,00

Available variants:

Front variants			
Mounting frame, black 50 mm		SET211200	7833,50

Energy efficiency class A



BSK 07 high right side

Set consists of:	Art. No.	No.	Price
Eck 38/86/36, right side , lifting door, single glazing two-piece ceramic glass, outlet ø 200 mm		1	
Chamotte lining set Eck 38/86/36		1	
Support bearing BSK 07		1	
Thermal concrete cladding BSK 07		1	

Additional options			
Heat protective panels for BSK 07 side & back walls	BSK7000-131		288,00
Damper flap ø 200 mm with stainless steel handle	02460+10275		292,50
Smoke pipe adapter for horizontal/vertical outlet Spare connecting piece not possible	BSK7000-129		405,50
Counterweights for non-self closing door	49097		46,50
Additional ring for raised cladding BSK 07 *	BSK7000-007		352,00
* Differences of colour between the height extension ring and other components of BSK/BSO are due to manufacturing process and cannot be excluded. These colour differences are no reason for a claim.			
EAS (see page 165)			1561,50
Reduced price for EAS without display			-148,00
Socket blend stainless steel	BSK7000-137		167,00

Available variants:

Front variants			
Mounting frame, black 50 mm		SET211202	7833,50

Energy efficiency class A



BSK 12 Corner fireplace waterbearing 42/57/30 left side, side-opening door

Set consists of:	Art. No.	No.	Price
Corner fireplace waterbearing 42/57/30, left side, side-opening door two-piece ceramic glass, outlet ø 180 mm		1	
Chamotte lining set, bright, for Eck-Kamin 42/57/30		1	
Mounting frame		1	
Thermal concrete cladding BSK 12		1	

Additional options			
EOS (see page 165)			2829,00
EAS (see page 165)			1561,50
Reduced price for EAS without display			-148,00
Air flap adapter ø 125 mm for direct assembly motor at device	N003156		24,00
Set heat-protective panel	BSK12000-124		43,50
Additional ring for raised cladding BSK 12 *	BSK12000-007		297,00
* Differences of colour between the height extension ring and other components of BSK/BSO are due to manufacturing process and cannot be excluded. These colour differences are no reason for a claim.			
Socket blend stainless steel	BSK12000-017		167,00

Available variants:

Front variants			
Mounting frame, black 50 mm		SET213020	7367,00

Energy efficiency index A +

BSK 12 Corner fireplace waterbearing 42/57/30 right side, side-opening door



Set consists of:	Art. No.	No.	Price
Corner fireplace waterbearing 42/57/30, right side, side-opening door two-piece ceramic glass, outlet ø 180 mm		1	
Chamotte lining set, bright, for Eck-Kamin 42/57/30		1	
Mounting frame		1	
Thermal concrete cladding BSK 12		1	

Additional options			
EOS (see page 165)			2829,00
EAS (see page 165)			1561,50
Reduced price for EAS without display			-148,00
Air flap adapter ø 125 mm for direct assembly motor at device	N003156		24,00
Set heat-protective panel	BSK12000-124		43,50
Additional ring for raised cladding BSK 12 *	BSK12000-007		297,00
* Differences of colour between the height extension ring and other components of BSK/BSO are due to manufacturing process and cannot be excluded. These colour differences are no reason for a claim.			
Socket blend stainless steel	BSK12000-017		167,00

Available variants:

Front variants			
Mounting frame, black 50 mm		SET213021	7367,00

Energy efficiency index A +

flat

Tunnel

BSK

Eck

Panorama



BSK 12 Eck 42/57/30 left side, side-opening door

Set consists of:	Art. No.	No.	Price
Eck 42/57/30, left side , side-opening door, single glazing two-piece ceramic glass, outlet ø 200 mm		1	
Chamotte lining set Eck 42/57/30 l		1	
Mounting frame		1	
Thermal concrete cladding BSK 12		1	

Additional options			
Heat protective panels for BSK 12 side & back walls	BSK12000-120		212,00
Damper flap ø 200 mm with stainless steel handle	02460+10275		292,50
Additional ring for raised cladding BSK 12 *	BSK12000-007		297,00
* Differences of colour between the height extension ring and other components of BSK/BSO are due to manufacturing process and cannot be excluded. These colour differences are no reason for a claim.			
EAS (see page 165)			1561,50
Reduced price for EAS without display			-148,00
Air flap adapter ø 125 mm for direct assembly motor at device	N003156		24,00
Socket blend stainless steel	BSK12000-017		167,00

Available variants:

Front variants			
Mounting frame, black 50 mm		SET213022	5759,50

Energy efficiency index A +

BSK 12 Eck 42/57/30 right side, side-opening door

Set consists of:	Art. No.	No.	Price
Eck 42/57/30, right side , side-opening door, single glazing two-piece ceramic glass, outlet ø 200 mm		1	
Chamotte lining set Eck 42/57/30 r		1	
Mounting frame		1	
Thermal concrete cladding BSK 12		1	

Additional options			
Heat protective panels for BSK 12 side & back walls	BSK12000-120		212,00
Damper flap ø 200 mm with stainless steel handle	02460+10275		292,50
Additional ring for raised cladding BSK 12 *	BSK12000-007		297,00
* Differences of colour between the height extension ring and other components of BSK/BSO are due to manufacturing process and cannot be excluded. These colour differences are no reason for a claim.			
EAS (see page 165)			1561,50
Reduced price for EAS without display			-148,00
Air flap adapter ø 125 mm for direct assembly motor at device	N003156		24,00
Socket blend stainless steel	BSK12000-017		167,00

Available variants:

Front variants			
Mounting frame, black 50 mm		SET213023	5759,50

Energy efficiency index A +

flat

Tunnel

BSK

Eck

Panorama



BSK 10

Set consists of:	Art. No.	No.	Price
Panorama 42/42/42/42, outlet ø 200 mm		1	
Chamotte lining set Panorama 42/42/42/42		1	
Thermal concrete cladding BSK 10		1	

Additional options			
Heat protective panels for BSK 10 back wall	BSK10000-124		144,00
Damper flap ø 200 mm with stainless steel handle	02460+10275		292,50
Additional ring for raised cladding BSK 10 *	BSK10000-012		232,50
* Differences of colour between the height extension ring and other components of BSK/BSO are due to manufacturing process and cannot be excluded. These colour differences are no reason for a claim.			
Counterweights for non-self closing door	49097		46,50
Exchange connecting piece ø 180 mm	I058043		77,00
Socket blend stainless steel	BSK10000-128		167,00

Available variants:

Front variants			
Fire table, black		SET211404	7850,00

Energy efficiency class A

BSK 11



Set consists of:	Art. No.	No.	Price
Panorama 70/25/40/25 outlet ø 200 mm		1	
Chamotte lining set Panorama 70/25/40/25		1	
Thermal concrete cladding BSK 11		1	

Additional options			
Heat protective panels for BSK 11 back wall	BSK11000-124		152,50
Damper flap ø 200 mm with stainless steel handle	02460+10275		292,50
Additional ring for raised cladding BSK 11 *	BSK11000-012		270,00
* Differences of colour between the height extension ring and other components of BSK/BSO are due to manufacturing process and cannot be excluded. These colour differences are no reason for a claim.			
Counterweights for non-self closing door	49097		46,50
Exchange connecting piece ø 180 mm	I058043		77,00
Socket blend stainless steel	BSK11000-129		167,00

Available variants:

Front variants			
Fire table, black		SET211406	8403,50

Energy efficiency index A +



BSK 5.1

Set consists of:	Art. No.	No.	Price
Panorama 57/40/60/40 , outlet ø 200 mm		1	
Chamotte lining set Panorama 57/40/60/40		1	
Thermal concrete cladding BSK 5.1		1	

Additional options			
Heat protective panels for BSK 5.1 back wall	BSK5000-139		99,50
Smoke pipe adapter for horizontal/vertical outlet inclusive spare connecting piece	I009168		429,00
Damper flap ø 200 mm with stainless steel handle	02460+10275		292,50
Connection adapter ø 160 mm for changing the combustion air supply from side to rear	BSK5000-130		116,00
Additional ring for raised cladding BSK 5.1 *	BSK5000-014		312,00
* Differences of colour between the height extension ring and other components of BSK/BSO are due to manufacturing process and cannot be excluded. These colour differences are no reason for a claim.			
Counterweights for non-self closing door	49097		46,50
Exchange connecting piece ø 180 mm	I019448		61,00
Exchange connecting piece ø 250 mm	I019450		61,00
Socket blend stainless steel	BSK5000-133		167,00

Available variants:

Front variants			
Fire table, black		SET213069	8424,00

Energy efficiency class A



BSK 13

Set consists of:	Art. No.	No.	Price
Panorama 51/66/50/66 , with support bracket and heat protective panel outlet ø 200 mm		1	
Combustion chamber lining Panorama 51/66/50/66		1	
Thermal concrete cladding BSK 13		1	

Additional options			
Damper flap ø 200 mm with stainless steel handle	02460+10275		292,50
Additional ring for raised cladding BSK 13 *	BSK13000-006		312,50
* Differences of colour between the height extension ring and other components of BSK/BSO are due to manufacturing process and cannot be excluded. These colour differences are no reason for a claim.			
Counterweights for non-self closing door		included/modification	
Exchange connecting piece ø 180 mm	I019448		61,00
Exchange connecting piece ø 250 mm	I019450		61,00
Socket blend stainless steel	BSK13000-120		68,50

Available variants:

Front variants			
Fire table black		SET213096	9793,50

Energy efficiency index A +

Glazing formats

Flat glazing

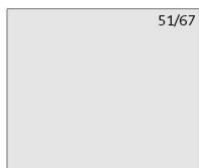

BSG 01

Door dimensions height x width in cm

from
page
232

Eck corners



BSG 02

Door dimensions height x width x width in cm

from
page
236

flat

Eck

Door frame- Masonry stove kit systems



Door frame

Supplementary equipment

- EAS** Combustion controls with potential-free relay (without additional functions) consisting of display, 1 x flush-mount box, door switch, thermocouple & bus line, each 2 m long. Preassembled EAS/EOS components, door switch, thermocouple, motor box with transmission and \varnothing 125 mm air flap, flexible hose with adjustable clamps
- EOS** Combustion control with graphic touchscreen display and additional functions (differential temperature control, Moritz's flap control) consisting of: Display with control unit, 2 x flush-mount box, door switch, thermocouple, bus and connecting line, each 2 m long, 4 x water sensors with immersion sleeve and 2x extension cable 3 m. Preassembled EOS components: door switch, thermocouple, motor box with transmission and \varnothing 125 mm air flap, flexible hose with adjustable clamps



BSG 01 low with MSS heat storage set standing next

Set consists of:	Art. No.	No.	Price
GOT 51/67-ZL side-opening door, single glazing		1	
Door frame		1	
GOF 66x42		1	
MSS elbow 90°		2	
MSS heat storage module 20 cm		2	
MSS heat storage module 10 cm		2	
MSS elbow 90° with opening top		1	
MSS heat storage module 20 cm with opening		1	
MSS bypass 40		1	
MSS elbow 90° with cleanout top		2	
MSS elbow 90° with lining, double-layered		1	
MSS base plate 75		3	
MSSI insulating block 30x30 cm		3	
MSS steel tape ring		10	
MSS glue Thermofix 1000 1 kg		2	
MSS connecting block		1	
Thermal concrete cladding BSG 01 (MSS heat storage set standing next)		1	
Inlet adapter		1	
Outlet adapter		1	
Mounting kit (with two clamps and endless tape)		2	
MSS handle with rotating part		1	

Additional options			
Double glazing			289,00
Conversion kit right hinge door	02380		133,00

Available variants:

Front variants:			
Door frame, black		SET211476	9679,50

Energy efficiency index A +

BSG 01 low with MSS heat storage set standing next + EAS



Set consists of:	Art. No.	No.	Price
GOT 51/67-ZL side-opening door, single glazing		1	
Door frame		1	
GOF 66x42		1	
MSS elbow 90°		2	
MSS heat storage module 20 cm		2	
MSS heat storage module 10 cm		2	
MSS elbow 90° with opening top		1	
MSS heat storage module 20 cm with opening		1	
MSS bypass 40		1	
MSS elbow 90° with cleanout top		2	
MSS elbow 90° with lining, double-layered		1	
MSS base plate 75		3	
MSSI insulating block 30x30 cm		3	
MSS steel tape ring		10	
MSS glue Thermofix 1000 1 kg		2	
MSS connecting block		1	
Thermal concrete cladding BSG 01 (MSS heat storage set standing next)		1	
Inlet adapter		1	
Outlet adapter		1	
Mounting kit (with two clamps and endless tape)		2	
EAS (see page 165)		1	
Mounting box		1	
Door switch wiring 3 lm		1	
Thermocouple wiring 3 lm		1	
Bus wiring 3 lm		1	
MSS handle with rotating part		1	

Additional options

Reduced price for EAS without display			-148,00
Double glazing			289,00
Conversion kit right hinge door	02380		133,00

Available variants:

Front variants:			
Door frame, black		SET211478	11266,50

Energy efficiency index A +



BSG 01 high with MSS heat storage set standing on top

Set consists of:	Art. No.	No.	Price
GOT 51/67-ZL side-opening door, single glazing		1	
Door frame		1	
GOF 66x42		1	
MSS elbow 90° with lining, double-layered		1	
MSS elbow 90°		4	
MSS outlet block ø 180 with sealing		1	
MSS heat storage module 10 cm with damper flap		1	
MSS elbow 90° with cleanout top		1	
MSS elbow 90° with cleanout left		1	
MSS heat storage module 20 cm		2	
MSS steel tape ring		11	
MSS glue Thermofix 1000 1 kg		2	
MSS connecting block		1	
Thermal concrete cladding BSG 01 (high)		1	
MSS handle with rotating part		1	

Additional options

Double glazing			289,00
Conversion kit right hinge door	02380		133,00

Available variants:

Front variants:			
Door frame, black		SET211480	8540,50

Energy efficiency index A +

BSG 01 high with MSS heat storage set standing on top + EAS



Set consists of:	Art. No.	No.	Price
GOT 51/67-ZL side-opening door, single glazing		1	
Door frame		1	
GOF 66x42		1	
MSS elbow 90° with lining, double-layered		1	
MSS elbow 90°		4	
MSS outlet block ø180		1	
MSS heat storage module 10 cm		1	
MSS elbow 90° with cleanout top		1	
MSS elbow 90° with cleanout left		1	
MSS heat storage module 20 cm		2	
MSS steel tape ring		11	
MSS glue Thermofix 1000 1 kg		2	
MSS connecting block		1	
Thermal concrete cladding BSG 01 (high)		1	
EAS (see page 165)		1	
Mounting box		1	
Door switch wiring 3 lm		1	
Thermocouple wiring 3 lm		1	
Bus wiring 3 lm		1	
MSS handle with rotating part		1	

Additional options

Reduced price for EAS without display			-148,00
Double glazing			289,00
Conversion kit right hinge door	02380		133,00

Available variants:

Front variants:			
Door frame, black		SET211482	10127,50

Energy efficiency index A +

BSG 02 low left side with MSS heat storage set standing next



flat

Set consists of:	Art. No.	No.	Price
GOT 45/67/44-ZL L, single glazing two-piece ceramic glass		1	
Door frame		1	
GOF 50x35		1	
MSS elbow 90°		2	
MSS heat storage module 20 cm		2	
MSS heat storage module 10 cm		2	
MSS elbow 90° with opening top		1	
MSS heat storage module 20 cm with opening		1	
MSS bypass 40		1	
MSS elbow 90° with cleanout top		2	
MSS elbow 90° with lining, double-layered		1	
MSS base plate 75		3	
MSSI insulating block 30x30 cm		3	
MSS steel tape ring		10	
MSS glue Thermofix 1000 1 kg		2	
MSS connecting block		1	
Thermal concrete cladding BSG 02 (MSS heat storage set standing next)		1	
Inlet adapter		1	
Outlet adapter		1	
Mounting kit (with two clamps and endless tape)		2	
MSS handle with rotating part		1	

Additional options

MSS connecting block backwall	G015107		0,00
instead MSS connecting block / GOF short side (G023205) the MSS connecting block backwall (G015107) will be delivered			

Available variants:

Front variants:			
Door frame, black		SET211488	10780,50

Energy efficiency index A +

BSG

Eck

BSG 02 low left side with MSS heat storage set standing next + EAS



Set consists of:	Art. No.	No.	Price
GOT 45/67/44-ZL L, single glazing two-piece ceramic glass		1	
Door frame		1	
GOF 50x35		1	
MSS elbow 90°		2	
MSS heat storage module 20 cm		2	
MSS heat storage module 10 cm		2	
MSS elbow 90° with opening top		1	
MSS heat storage module 20 cm with opening		1	
MSS bypass 40		1	
MSS elbow 90° with cleanout top		2	
MSS elbow 90° with lining, double-layered		1	
MSS base plate 75		3	
MSSI insulating block 30x30 cm		3	
MSS steel tape ring		10	
MSS glue Thermofix 1000 1 kg		2	
MSS connecting block		1	
Thermal concrete cladding BSG 02 (MSS heat storage set standing next)		1	
Inlet adapter		1	
Outlet adapter		1	
Mounting kit (with two clamps and endless tape)		2	
EAS (see page 165)		1	
Mounting box		1	
Door switch wiring 3 lm		1	
Thermocouple wiring 3 lm		1	
Bus wiring 3 lm		1	
MSS handle with rotating part		1	

Additional options

MSS connecting block backwall	G015107		0,00
instead MSS connecting block / GOF short side (G023205) the MSS connecting block backwall (G015107) will be delivered			
Reduced price for EAS without display			-148,00

Available variants:

Front variants:			
Door frame, black		SET211490	12367,50

Energy efficiency index A +

BSG 02 low right side with MSS heat storage set standing next



Set consists of:	Art. No.	No.	Price
GOT 45/67/44-ZL R , single glazing two-piece ceramic glass		1	
Door frame		1	
GOF 50x35		1	
MSS elbow 90°		2	
MSS heat storage module 20 cm		2	
MSS heat storage module 10 cm		2	
MSS elbow 90° with opening top		1	
MSS heat storage module 20 cm with opening		1	
MSS bypass 40		1	
MSS elbow 90° with cleanout top		2	
MSS elbow 90° with lining, double-layered		1	
MSS base plate 75		3	
MSSI insulating block 30x30 cm		3	
MSS steel tape ring		10	
MSS glue Thermofix 1000 1 kg		2	
MSS connecting block		1	
Thermal concrete cladding BSG 02 (MSS heat storage set standing next)		1	
Inlet adapter		1	
Outlet adapter		1	
Mounting kit (with two clamps and endless tape)		2	
MSS handle with rotating part		1	

Additional options

MSS connecting block backwall	G015107		0,00
instead MSS connecting block / GOF short side (G023204) the MSS connecting block backwall (G015107) will be delivered			

Available variants:

Front variants:			
Door frame, black		SET211484	10780,50

Energy efficiency index A +

BSG 02 low right side with MSS heat storage set standing next + EAS



Set consists of:	Art. No.	No.	Price
GOT 45/67/44-ZL R, single glazing two-piece ceramic glass		1	
Door frame		1	
GOF 50x35		1	
MSS elbow 90°		2	
MSS heat storage module 20 cm		2	
MSS heat storage module 10 cm		2	
MSS elbow 90° with opening top		1	
MSS heat storage module 20 cm with opening		1	
MSS bypass 40		1	
MSS elbow 90° with cleanout top		2	
MSS elbow 90° with lining, double-layered		1	
MSS base plate 75		3	
MSSI insulating block 30x30 cm		3	
MSS steel tape ring		10	
MSS glue Thermofix 1000 1 kg		2	
MSS connecting block		1	
Thermal concrete cladding BSG 02 (MSS heat storage set standing next)		1	
Inlet adapter		1	
Outlet adapter		1	
Mounting kit (with two clamps and endless tape)		2	
EAS (see page 165)		1	
Mounting box		1	
Door switch wiring 3 lm		1	
Thermocouple wiring 3 lm		1	
Bus wiring 3 lm		1	
MSS handle with rotating part		1	

Additional options

MSS connecting block backwall	G015107		0,00
instead MSS connecting block / GOF short side (G023204) the MSS connecting block backwall (G015107) will be delivered			
Reduced price for EAS without display			-148,00

Available variants:

Front variants:			
Door frame, black		SET211486	12367,50

Energy efficiency index A +



BSG 02 high left side with MSS heat storage set standing on top

Set consists of:	Art. No.	No.	Price
GOT 45/67/44-ZL L , single glazing two-piece ceramic glass		1	
Door frame		1	
GOF 50x35		1	
MSS elbow 90° with lining, double-layered		1	
MSS elbow 90°		3	
MSS outlet block ø180		1	
MSS elbow 90°		2	
MSS heat storage module 10 cm		1	
MSS steel tape ring		10	
MSS heat storage module with lining 20 cm, double-layered		1	
MSS base plate 100		4	
MSS elbow 90°		1	
MSSI insulating block 20x30 cm		2	
MSSI insulating block 30x30 cm		1	
MSS glue Thermofix 1000 1 kg		2	
Thermal concrete cladding BSG 02 (high)		1	
MSS handle with rotating part		1	

Available variants:

Front variants:			
Door frame, black		SET211496	9737,00

Energy efficiency index A +

BSG 02 high left side with MSS heat storage set standing on top + EAS



Set consists of:	Art. No.	No.	Price
GOT 45/67/44-ZL L, single glazing two-piece ceramic glass		1	
Door frame		1	
GOF 50x35		1	
MSS elbow 90° with lining, double-layered		1	
MSS elbow 90°		3	
MSS outlet block ø180		1	
MSS elbow 90°		2	
MSS heat storage module 10 cm		1	
MSS steel tape ring		10	
MSS heat storage module with lining 20 cm, double-layered		1	
MSS base plate 100		4	
MSS elbow 90°		1	
MSSI insulating block 20x30 cm		2	
MSSI insulating block 30x30 cm		1	
MSS glue Thermofix 1000 1 kg		2	
Thermal concrete cladding BSG 02 (high)		1	
EAS (see page 165)		1	
Mounting box		1	
Door switch wiring 3 lm		1	
Thermocouple wiring 3 lm		1	
Bus wiring 3 lm		1	
MSS handle with rotating part		1	

Additional options

Reduced price for EAS without display			-148,00
---------------------------------------	--	--	---------

Available variants:

Front variants:			
Door frame, black		SET211498	11324,00

Energy efficiency index A +

BSG 02 high right side with MSS heat storage set standing on top



flat

Set consists of:	Art. No.	No.	Price
GOT 45/67/44-ZL R, single glazing two-piece ceramic glass		1	
Door frame		1	
GOF 50x35		1	
MSS elbow 90° with lining, double-layered		1	
MSS elbow 90°		3	
MSS outlet block ø180		1	
MSS elbow 90°		2	
MSS heat storage module 10 cm		1	
MSS steel tape ring		10	
MSS heat storage module with lining 20 cm, double-layered		1	
MSS base plate 100		4	
MSS elbow 90°		1	
MSSI insulating block 20x30 cm		2	
MSSI insulating block 30x30 cm		1	
MSS glue Thermofix 1000 1 kg		2	
Thermal concrete cladding BSG 02 (high)		1	
MSS handle with rotating part		1	

Available variants:

Front variants:			
Door frame, black		SET211492	9737,00

Energy efficiency index A +

BSG 02 high right side with MSS heat storage set standing on top + EAS

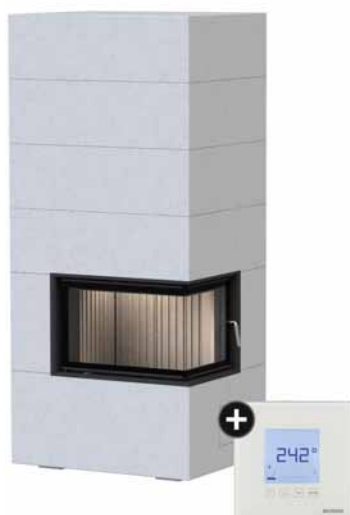

Set consists of:	Art. No.	No.	Price
GOT 45/67/44-ZL R, single glazing two-piece ceramic glass		1	
Door frame		1	
GOF 50x35		1	
MSS elbow 90° with lining, double-layered		1	
MSS elbow 90°		3	
MSS outlet block ø180		1	
MSS elbow 90°		2	
MSS heat storage module 10 cm		1	
MSS steel tape ring		10	
MSS heat storage module with lining 20 cm, double-layered		1	
MSS base plate 100		4	
MSS elbow 90°		1	
MSSI insulating block 20x30 cm		2	
MSSI insulating block 30x30 cm		1	
MSS glue Thermofix 1000 1 kg		2	
Thermal concrete cladding BSG 02 (high)		1	
EAS (see page 165)		1	
Mounting box		1	
Door switch wiring 3 lm		1	
Thermocouple wiring 3 lm		1	
Bus wiring 3 lm		1	
MSS handle with rotating part		1	

Additional options

Reduced price for EAS without display			-148,00
---------------------------------------	--	--	---------

Available variants:

Front variants:			
Door frame, black		SET211494	11324,00

Energy efficiency index A +

Glazing formats

Flat glazing



HKD 7

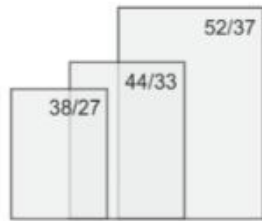

HKD Glass panes

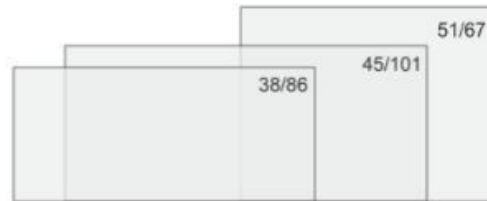

KK-Glass panes

from
page
246

Door dimensions height x width in cm

Tunnel formats



HKD 7

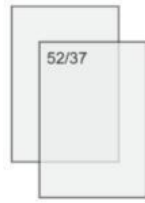

HKD 2.2.
HKD 2.2 XL



KK-Glass panes

from
page
264

Door dimensions height x width in cm

Eck corners

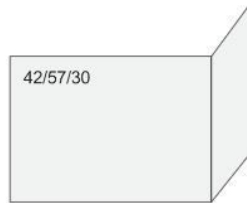

KK Glass panes



Door dimensions height x width in cm

from
page
278

Door frame - mounting frame HKD



Door frame



Mounting frame



Cast iron frame



Steel front plate
42 x 79 cm



Cast iron front plate
42 x 79 cm



Steel front plate
48 x 83 cm



Door frame
R = 330



Mounting frame
R = 380

Door frame - mounting frame Fireplace waterbearing



Door frame



Mounting frame 50 mm



Mounting frame 70 mm

Supplementary equipment

- EAS** Combustion controls with potential-free relay (without additional functions) consisting of display, 1 x flush-mount box, door switch, thermocouple & bus line, each 2 m long. Preassembled EAS/EOS components, door switch, thermocouple, motor box with transmission and \varnothing 125 mm air flap, flexible hose with adjustable clamps
- EOS** Combustion control with graphic touchscreen display and additional functions (differential temperature control, Moritz's flap control) consisting of: Display with control unit, 2 x flush-mount box, door switch, thermocouple, bus and connecting line, each 2 m long, 4 x water sensors with immersion sleeve and 2x extension cable 3 m. Preassembled EOS components: door switch, thermocouple, motor box with transmission and \varnothing 125 mm air flap, flexible hose with adjustable clamps



HKD 2.6.k SK side-opening door flat glass

Set consists of:	Art. No.	No.	Price
HKD 2.6 k SK , Double glazing		1	
Door frame, mounting frame, or front plate		1	
Inner lining set for HKD 2.6 k SK		1	
Upper lining HKD 2.6 k SK		1	
Support bearing HKD 2.6 k SK		1	

Additional options			
EAS (see page 245)			1561,50
Reduced price for EAS without display			-148,00
EOS (see page 245)			2829,00

Available variants:

Front variants:			
Door frame, black		SET209179	5252,00
Cast iron frame		SET209181	5265,50

Energy efficiency index A +

HKD 2.6.k SK cast iron doors

Set consists of:	Art. No.	No.	Price
HKD 2.6 k SK , cast iron doors		1	
Cast iron frame, front plate		1	
Inner lining set for HKD 2.6 k SK		1	
Upper lining HKD 2.6 k SK		1	
Support bearing HKD 2.6 k SK		1	

Additional options			
EAS (see page 245)			1561,50
Reduced price for EAS without display			-148,00
EOS (see page 245)			2829,00

Available variants:

Front variants:			
Cast iron frame		SET209185	5265,50

Energy efficiency index A +







B7 side-opening door flat glass

Set consists of:	Art. No.	No.	Price
B7 with doors HKD 6.1 DF, single glazing		1	
Door frame / Cast iron frame / front plate		1	
Inner lining set for B7		1	
Upper lining B7		1	
Support bearing B7		1	

Additional options			
EAS (see page 245)			1561,50
Reduced price for EAS without display			-148,00
EOS (see page 245)			2829,00
Double glazing			0,00

Available variants:

Front variants:				
Door frame, black		SET209045		4709,50
Door frame, stainless steel		SET209046		4769,00
Cast iron frame		SET209047		4723,00
Steel front plate, black 48 x 83 cm		SET209048		4890,50
Cast iron front plate 48 x 83 cm		SET209053		4857,00

Energy efficiency index A +



B7 side-opening door cast iron doors



Set consists of:	Art. No.	No.	Price
B7 with doors , DF, cast iron doors		1	
Cast iron frame / front plate		1	
Inner lining set for B7		1	
Upper lining B7		1	
Support bearing B7		1	

Additional options			
EAS (see page 245)			1561,50
Reduced price for EAS without display			-148,00
EOS (see page 245)			2829,00

Available variants:

Front variants:				
Cast iron frame		SET209058		4723,00
Cast iron front plate 48 x 83 cm		SET209059		4857,00

Energy efficiency index A +





B8 side-opening door flat glass

Set consists of:	Art. No.	No.	Price
B8 with doors , HKD 6.1 DF, single glazing		1	
Door frame / Cast iron frame / front plate		1	
Inner lining set for B8		1	
Upper lining B8		1	
Support bearing B8		1	

Additional options			
EAS (see page 245)			1561,50
Reduced price for EAS without display			-148,00
EOS (see page 245)			2829,00
Double glazing			0,00

Available variants:

Front variants:				
Door frame, black		SET209060		5147,00
Door frame, stainless steel		SET209061		5206,50
Cast iron frame		SET209062		5160,50
Steel front plate, black 48 x 83 cm		SET209063		5328,00
Cast iron front plate 48 x 83 cm		SET209064		5294,50

Energy efficiency index A +

B8 side-opening door cast iron doors



Set consists of:	Art. No.	No.	Price
B8 with doors , HKD 6.1 DF, cast iron doors		1	
Cast iron frame / front plate		1	
Inner lining set for B8		1	
Upper lining B8		1	
Support bearing B8		1	

Additional options			
EAS (see page245)			1561,50
Reduced price for EAS without display			-148,00
EOS (see page245)			2829,00

Available variants:

Front variants:				
Cast iron frame		SET209070		5160,50
Cast iron front plate 48 x 83 cm		SET209071		5294,50

Energy efficiency index A +







B4 side-opening door flat glass



Set consists of:	Art. No.	No.	Price
B4 with doors , HKD 4.1 DF, single glazing, with cleaning mechanism		1	
Door frame, mounting frame, or front plate		1	
Inner lining set for B4		1	
Upper lining B4		1	
Support bearing B4		1	
side/rear outlet		1	







Additional options			
EAS (see page245)			1561,50
Reduced price for EAS without display			-148,00
EOS (see page245)			2829,00
Smoke pipe connection with cover, top outlet ø 180 mm for Kompaktkessel B4			0,00
Conversion kit/ extension for cleaning on front	11726		199,50
Conversion kit/extension for cleaning on side	11727		157,00
Conversion kit for cleaning on top including push-in handle	BSK2000-201		209,50
Double glazing			0,00

Available variants:





Front variants:			
Door frame, black		SET209072	7709,00
Door frame, stainless steel		SET209073	7787,00
Mounting frame, black		SET208312	7749,00
Mounting frame, stainless steel		SET208313	7821,50
Cast iron frame		SET209074	7732,00
Steel front plate, black 48 x 83 cm		SET209075	7862,00
Cast iron front plate 48 x 83 cm		SET209082	7809,00

Smoke hood variants:



Cast iron hot air hood ø 180 mm	R014022-03	1	
Front variants:			
Door frame, black		SET213106	7995,00
Door frame, stainless steel		SET213107	8073,00
Mounting frame, black		SET213108	8035,00
Mounting frame, stainless steel		SET213109	8107,50
Cast iron frame		SET213110	8018,00
Steel front plate, black 48 x 83 cm		SET213111	8148,00
Cast iron front plate 48 x 83 cm		SET213112	8095,00



+ Modular accumulator MAS 440 double-layered		R009042	5	
Cast iron cover MAS ø 180		R009095-01	1	
Mounting ring		10077	1	
Front variants:				
Door frame, black		SET213113		9219,50
Door frame, stainless steel		SET213114		9297,50
Mounting frame, black		SET213115		9259,50
Mounting frame, stainless steel		SET213116		9332,00
Cast iron frame		SET213117		9242,50
Steel front plate, black 48 x 83 cm		SET213118		9372,50
Cast iron front plate 48 x 83 cm		SET213119		9319,50

Energy efficiency index A +

B4 side-opening door cast iron doors



Set consists of:	Art. No.	No.	Price
B4 with doors HKD 4.1, cast iron doors, with cleaning mechanism		1	
Cast iron frame, front plate		1	
Inner lining set for B4		1	
Upper lining B4		1	
Support bearing B4		1	
side/rear outlet		1	



Additional options			
EAS (see page245)			1561,50
Reduced price for EAS without display			-148,00
EOS (see page245)			2829,00
Smoke pipe connection with cover, top outlet ø 180 mm for Kompaktkessel B4			0,00
Conversion kit/ extension for cleaning on front	11726		199,50
Conversion kit/extension for cleaning on side	11727		157,00
Conversion kit for cleaning on top including push-in handle	BSK2000-201		209,50

Available variants:



Front variants:			
Cast iron frame		SET209087	7732,00
Cast iron front plate 48 x 83 cm		SET209088	7809,00

Smoke hood variants



Cast iron hot air hood ø 180 mm	R014022-03	1	
Front variants:			
Cast iron frame		SET213120	8018,00
Cast iron front plate 48 x 83 cm		SET213121	8095,00



+ Modular accumulator MAS 440 double-layered	R009042	5	
Cast iron cover MAS ø 180	R009095-01	1	
Mounting ring	10077	1	
Front variants:			
Cast iron frame		SET213122	9242,50
Cast iron front plate 48 x 83 cm		SET213123	9319,50

Energy efficiency index A +





HKD 2.2 k SK side-opening door flat glass

Set consists of:	Art. No.	No.	Price
HKD 2.2 k SK, Side-opening door, flat, single glazing		1	
Door frame, mounting frame, or front plate		1	
Inner lining set for HKD 2.2 k SK		1	
Upper lining HKD 2.2 k SK		1	
Support bearing HKD 2.2 k SK		1	

Additional options			
EAS (see page 245)			1561,50
Reduced price for EAS without display			-148,00
EOS (see page 245)			2829,00
Double glazing			160,00
Option front with door HKD 2.2 round glass			Price on request

Available variants:

Front variants:				
Door frame, black		SET209165		5189,50
Door frame, stainless steel		SET209166		5235,50
Mounting frame, black		SET209167		5290,50
Mounting frame, stainless steel		SET209168		5400,50
Cast iron front plate 48 x 83 cm		SET209170		5319,50
Steel front plate 48 x 83 cm		SET209171		5294,00

Energy efficiency index A +

HKD 2.2 SK + EAS (with Moritz's flap mode)

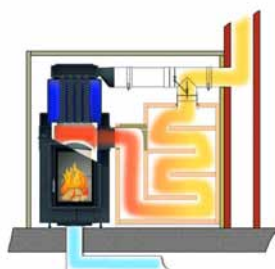

Heat storage mode with Moritz's flap



Boiler operation with Moritz's flap

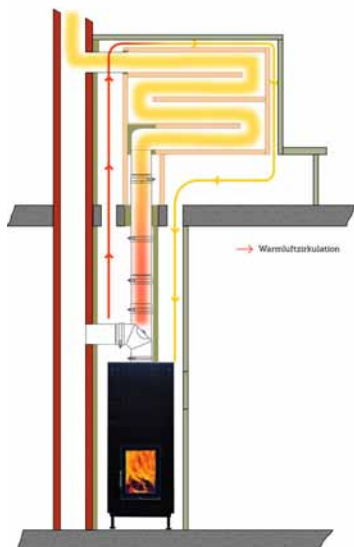

Additional option: smoke pipe connection kit instead Moritz's flap

Set consists of:	Art. No.	No.	Price
HKD 2.2 SK DF side-opening door flat glass, single glazed for EAS/EOS, with cleaning mechanism		1	
Door frame or mounting frame		1	
Inner lining set for HKD 2.2 SK flat/round		1	
Upper lining HKD 2.2 SK		1	
Moritz's smoke valve		1	
EAS (see page 245)		1	
Mounting box		1	
Door switch wiring 2 lm		1	
Thermocouple wiring 2 lm		1	
Bus wiring 2 lm		1	
Connecting piece for side/rear smoke outlet ø 180 mm / Boiler		1	
Connecting piece for side/rear smoke outlet ø 180 mm / Reheater		1	

Additional options			
Add. charge EOS ¹			1267,50
Reduced price for EAS without display			-148,00
Smoke pipe outlet on top ø 180 mm	W043140		0,00
Smoke valve actuator with insulation (10338 and 10329) ²			717,50
Conversion kit/ extension for cleaning on front	11726		199,50
Conversion kit/extension for cleaning on side	W043135		191,50
Double glazing			160,00
Front option with HKD 2.6 door (optional double glass, simple glass or control window)			Price on request
Option front with door HKD 2.2 round glass			Price on request

Available variants:

Front variants:			
Door frame, black		SET209400	10267,00
Door frame, stainless steel		SET209401	10313,00
Mounting frame, black		SET209402	10368,00
Mounting frame, stainless steel		SET209403	10478,00

¹compared to EAS: EOS control & display unit, second flush-mount box, connecting cable for control & display unit 2m long, 4x water temperature sensor with sleeve and 2x extension cable 3m long.

²possible only in combination with EOS.

Energy efficiency index A +

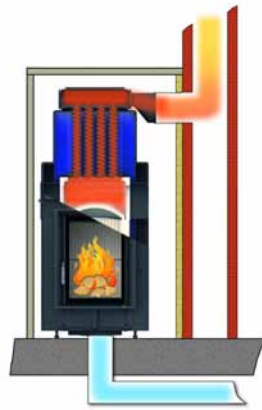

Boiler operation with direct connection

HKD 2.2 SK with direct connection + EAS

Set consists of:	Art. No.	No.	Price
HKD 2.2 SK DF side-opening door flat glass, single glazed for EAS/EOS, with cleaning mechanism		1	
Door frame or mounting frame		1	
Inner lining set for HKD 2.2 SK flat/round		1	
Upper lining HKD 2.2 SK		1	
EAS (see page 245)		1	
Mounting box		1	
Door switch wiring 2 lm		1	
Thermocouple wiring 2 lm		1	
Bus wiring 2 lm		1	
Connecting piece for side/rear smoke outlet ø 180 mm		1	

Additional options			
Add. charge EOS ¹			1267,50
Reduced price for EAS without display			-148,00
Smoke pipe outlet on top ø 180 mm	W043140		0,00
Conversion kit/ extension for cleaning on front	11726		199,50
Conversion kit/extension for cleaning on side	W043135		191,50
Double glazing			160,00
Front option with HKD 2.6 door (optional double glass, simple glass or control window)			Price on request
Option front with door HKD 2.2 round glass			Price on request

Available variants:

Front variants:			
Door frame, black		SET209414	9810,50
Door frame, stainless steel		SET209415	9856,50
Mounting frame, black		SET209416	9911,50
Mounting frame, stainless steel		SET209417	10021,50

¹compared to EAS: EOS control & display unit, second flush-mount box, connecting cable for control & display unit 2m long, 4x water temperature sensor with sleeve and 2x extension cable 3m long.

Energy efficiency index A +

HKD 2.2 XL SK/h + EAS (with Moritz's flap mode)



Heat storage mode with Moritz's flap



Boiler operation with Moritz's flap

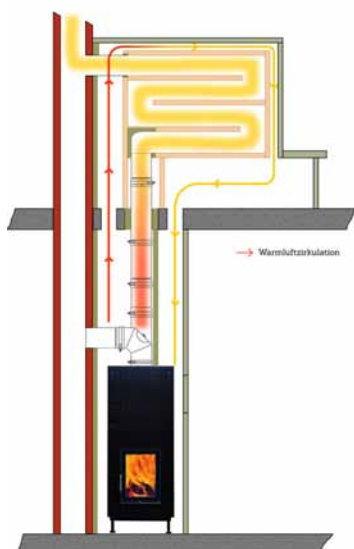

Additional option: smoke pipe connection kit instead Moritz's flap

Set consists of:	Art. No.	No.	Price
HKD 2.2 XL SK/h DF side-opening door flat glass , single glazed for EAS/EOS with cleaning mechanism		1	
Door frame or mounting frame		1	
Inner lining set for HKD 2.2 XL SK /h flat/round		1	
Upper lining HKD 2.2 XL SK /h		1	
Moritz's smoke valve		1	
EAS (see page 245)		1	
Mounting box		1	
Door switch wiring 2 lm		1	
Thermocouple wiring 2 lm		1	
Bus wiring 2 lm		1	
Connecting piece for side/rear smoke outlet ø 180 mm / Boiler		1	
Connecting piece for side/rear smoke outlet ø 180 mm / Reheater		1	

Additional options			
Add. charge EOS ¹			1267,50
Reduced price for EAS without display			-148,00
Smoke pipe outlet on top ø 180 mm	W043140		0,00
Smoke valve actuator with insulation (10338 and 10329) ²			717,50
Conversion kit/ extension for cleaning on front	11726		199,50
Conversion kit/extension for cleaning on side	W043135		191,50
Double glazing			160,00
Front option with HKD 2.6 door (optional double glass, simple glass or control window)			Price on request
Option front with door HKD 2.2 round glass			Price on request

Available variants:

Front variants:			
Door frame, black		SET209428	10627,50
Door frame, stainless steel		SET209429	10673,50
Mounting frame, black		SET209430	10728,50
Mounting frame, stainless steel		SET209431	10838,50

¹compared to EAS: EOS control & display unit, second flush-mount box, connecting cable for control & display unit 2m long, 4x water temperature sensor with sleeve and 2x extension cable 3m long.

²possible only in combination with EOS.

Energy efficiency index A +

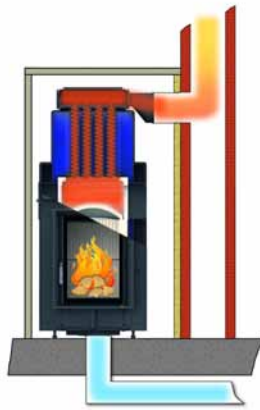

Boiler operation with direct connection

HKD 2.2 XL SK/h with direct connection + EAS

Set consists of:	Art. No.	No.	Price
HKD 2.2 XL SK/h DF side-opening door flat glass , single glazed for EAS/EOS with cleaning mechanism		1	
Door frame or mounting frame		1	
Inner lining set for HKD 2.2 XL SK /h flat/round		1	
Upper lining HKD 2.2 XL SK /h		1	
EAS (see page 245)		1	
Mounting box		1	
Door switch wiring 2 lm		1	
Thermocouple wiring 2 lm		1	
Bus wiring 2 lm		1	
Connecting piece for side/rear smoke outlet ø 180 mm		1	

Additional options			
Add. charge EOS ¹			1267,50
Reduced price for EAS without display			-148,00
Smoke pipe outlet on top ø 180 mm	W043140		0,00
Conversion kit/ extension for cleaning on front	11726		199,50
Conversion kit/extension for cleaning on side	W043135		191,50
Double glazing			160,00
Front option with HKD 2.6 door (optional double glass, simple glass or control window)			Price on request
Option front with door HKD 2.2 round glass			Price on request

Available variants:

Front variants:			
Door frame, black		SET209433	10171,00
Door frame, stainless steel		SET209434	10217,00
Mounting frame, black		SET209435	10272,00
Mounting frame, stainless steel		SET209436	10382,00

¹compared to EAS: EOS control & display unit, second flush-mount box, connecting cable for control & display unit 2m long, 4x water temperature sensor with sleeve and 2x extension cable 3m long.

Energy efficiency index A +

HKD 7 SK + EAS (with Moritz's flap mode)

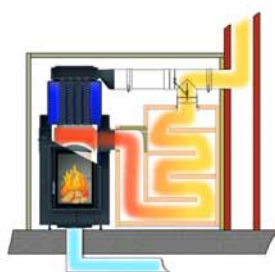

Heat storage mode
with Moritz's flap



Boiler operation
with Moritz's flap

Set consists of:	Art. No.	No.	Price
HKD 7 SK DF side-opening door flat glass, single glazed for EAS/EOS, with cleaning mechanism		1	
Door frame or mounting frame		1	
Inner lining set for HKD 7 SK		1	
Upper lining HKD 7 SK		1	
Moritz's smoke valve		1	
EAS (see page 245)		1	
Mounting box		1	
Door switch wiring 2 lm		1	
Thermocouple wiring 2 lm		1	
Bus wiring 2 lm		1	
Connecting piece for side/rear smoke outlet ø 180 mm / Boiler		1	
Connecting piece for side/rear smoke outlet ø 180 mm / Reheater		1	

Additional options			
Add. charge EOS ¹			1267,50
Reduced price for EAS without display			-148,00
Smoke pipe outlet on top ø 180 mm	W043140		0,00
Smoke valve actuator with insulation (10338 and 10329) ²			717,50
Conversion kit/ extension for cleaning on front	11726		199,50
Conversion kit/extension for cleaning on side	W043135		191,50
Conversion kit for cleaning on top including push-in handle	BSO5000-123		212,00
Double glazing			160,00

Available variants:

Front variants:			
Door frame, black		SET213002	11591,00
Mounting frame, black		SET213003	11577,00

¹compared to EAS: EOS control & display unit, second flush-mount box, connecting cable for control & display unit 2m long, 4x water temperature sensor with sleeve and 2x extension cable 3m long.

²possible only in combination with EOS.

Energy efficiency index A +

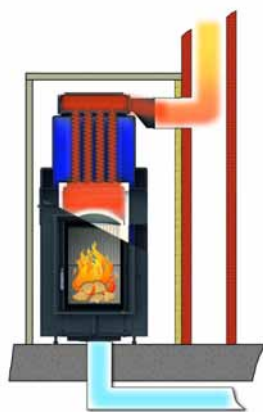

Boiler operation with direct connection

HKD 7 SK with direct connection + EAS

Set consists of:	Art. No.	No.	Price
HKD 7 SK DF side-opening door flat glass, single glazed for EAS/EOS, with cleaning mechanism		1	
Door frame or mounting frame		1	
Inner lining set for HKD 7 SK		1	
Upper lining HKD 7 SK		1	
EAS (see page 245)		1	
Mounting box		1	
Door switch wiring 2 lm		1	
Thermocouple wiring 2 lm		1	
Bus wiring 2 lm		1	
Connecting piece for side/rear smoke outlet ø 180 mm		1	

Additional options			
Add. charge EOS ¹			1267,50
Reduced price for EAS without display			-148,00
Smoke pipe outlet on top ø 180 mm	W043140		0,00
Conversion kit/ extension for cleaning on front	11726		199,50
Conversion kit/extension for cleaning on side	W043135		191,50
Conversion kit for cleaning on top including push-in handle	BSO5000-123		212,00
Double glazing			160,00

Available variants:

Front variants:			
Door frame, black		SET213004	11134,50
Mounting frame, black		SET213005	11120,50

¹compared to EAS: EOS control & display unit, second flush-mount box, connecting cable for control & display unit 2m long, 4x water temperature sensor with sleeve and 2x extension cable 3m long.

Energy efficiency index A +

Stil-Kamin 51/67 side-opening door, single glazing, with top-mount boiler



Set consists of:	Art. No.	No.	Price
Stil-Kamin 51/67 , side-opening door, single glazing		1	
Door frame		1	
Chamotte lining set Stil 51/67		1	
ISO upper lining / deflection		1	
Top-mount boiler		1	

Additional options			
EAS (see page 245)			1561,50
Reduced price for EAS without display			-148,00
EOS (see page 245)			2829,00
Smoke pipe adapter for horizontal outlet	BSK7000-129		405,50
Exchange connecting piece ø 180 mm	I058043		77,00
Double glazing			289,00

Available variants:

Front variants:			
Door frame, black		SET210553	5822,50

Energy efficiency index A +



Stil-Kamin 51/67 lifting door, single glazing, with top-mount boiler

Set consists of:	Art. No.	No.	Price
Stil-Kamin 51/67 , lifting door, single glazing		1	
Door frame or mounting frame		1	
Chamotte lining set Stil 51/67		1	
ISO upper lining / deflection		1	
Top-mount boiler		1	

Additional options			
EAS (see page 245)			1561,50
Reduced price for EAS without display			-148,00
EOS (see page 245)			2829,00
Smoke pipe adapter for horizontal outlet	BSK7000-129		405,50
Exchange connecting piece ø 180 mm	I058043		77,00
Double glazing			289,00
Counterweights for non-self closing door	49097		46,50

Available variants:

Front variants:			
Door frame, black		SET210555	6676,00
Mounting frame, black, 50 mm		SET210557	6676,00
Mounting frame, black, 70 mm		SET210559	6740,00

Energy efficiency index A +

flat

Tunnel

Additional door DHT

Eck

Heating Center

Boiler

Architektur-Kamin 38/86, lifting door with top-mount boiler



Set consists of:	Art. No.	No.	Price
AK 38/86 , lifting door, single glazing		1	
Door frame or mounting frame		1	
Inner lining set for Stil AK 38/86		1	
ISO upper lining / deflection		1	
Top-mount boiler AK 38/86		1	

Additional options			
EAS (see page 245)			1561,50
Reduced price for EAS without display			-148,00
EOS (see page 245)			2829,00
Smoke pipe adapter for horizontal/vertical outlet	BSK7000-129		405,50
Exchange connecting piece ø 180 mm	I058043		77,00
Double glazing			320,00

Available variants:

Front variants:			
Door frame, black		SET208761	8082,50
Mounting frame, black, 50 mm		SET208763	8036,00
Mounting frame, black, 70 mm		SET208923	8056,50

Energy efficiency index A +





Architektur-Kamin 45/101, lifting door with top-mount boiler

Set consists of:	Art. No.	No.	Price
AK 45/101 , lifting door, single glazing		1	
Door frame or mounting frame		1	
Inner lining set for Stil AK 45/101		1	
ISO upper lining / deflection		1	
Top-mount boiler AK 45/101		1	

Additional options			
EAS (see page 245)			1561,50
Reduced price for EAS without display			-148,00
EOS (see page 245)			2829,00
Smoke pipe adapter for horizontal outlet	I019490		299,00
Double glazing			405,00
Counterweights for non-self closing door	49097		46,50

Available variants:

Front variants:				
Door frame, black		SET205287		8347,00
Mounting frame, black, 50 mm		SET205289		8299,00
Mounting frame, black, 70 mm		SET208925		8335,00

Energy efficiency index A +

flat

Tunnel

Additional door DHT

Eck

Heating Center

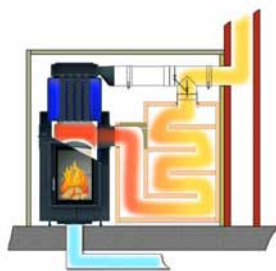

Heat storage mode
with Moritz's flap

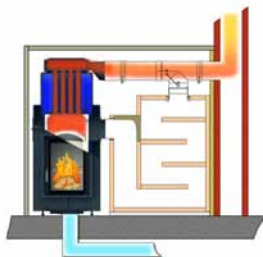

Boiler operation
with Moritz's flap

HKD 2.2 SK Tunnel + EAS (with Moritz's flap mode)

Set consists of:	Art. No.	No.	Price
HKD 2.2 SK DF/DF side-opening door flat glass, Tunnel single glazed for EAS/EOS, with cleaning mechanism		1	
Door frame or mounting frame		2	
Inner lining set for HKD 2.2 SK Tunnel flat/round		1	
Upper lining HKD 2.2 SK		1	
Moritz's smoke valve		1	
EAS (see page 245)		1	
Mounting box		1	
Door switch wiring 2 lm		1	
Thermocouple wiring 2 lm		1	
Bus wiring 2 lm		1	
Connecting piece for side/rear smoke outlet ø 180 mm		1	
Smoke pipe connecting piece ø 180 mm Side		1	

Additional options

Add. charge EOS ¹			1267,50
Reduced price for EAS without display			-148,00
Smoke pipe outlet on top ø 180 mm	W043140		0,00
Smoke valve actuator with insulation (10338 and 10329) ² (EOS 6 is required)			717,50
Conversion kit/ extension for cleaning on front	11726		199,50
Conversion kit/extension for cleaning on side	W043135		191,50
Double glazing			320,00
Door lock as revision handle	02429		70,00
Option front with door HKD 2.2 round glass			Price on request

Available variants:

Front variants:			
Door frame, black		SET209407	11714,50
Door frame, stainless steel		SET209408	11806,50
Mounting frame, black		SET209409	11916,50
Mounting frame, stainless steel		SET209410	12136,50

¹ compared to EAS: EOS control & display unit, second flush-mount box, connecting cable for control & display unit 2m long, 4x water temperature sensor with sleeve and 2x extension cable 3m long.

² possible only in combination with EOS.

Energy efficiency index A +

HKD 2.2 SK Tunnel with direct connection incl. EAS



Boiler operation with direct connection

Set consists of:	Art. No.	No.	Price
HKD 2.2 SK DF/DF side-opening door flat glass, Tunnel single glazed for EAS/EOS, with cleaning mechanism		1	
Door frame or mounting frame		2	
Inner lining set for HKD 2.2 SK Tunnel flat/round		1	
Upper lining HKD 2.2 SK		1	
EAS (see page 245)		1	
Mounting box		1	
Door switch wiring 2 lm		1	
Thermocouple wiring 2 lm		1	
Bus wiring 2 lm		1	
Connecting piece for side/rear smoke outlet \varnothing 180 mm		1	

Additional options			
Add. charge EOS ¹			1267,50
Reduced price for EAS without display			-148,00
Smoke pipe outlet on top \varnothing 180 mm	W043140		0,00
Conversion kit/ extension for cleaning on front	11726		199,50
Conversion kit/extension for cleaning on side	W043135		191,50
Double glazing			320,00
Door lock as revision handle	02429		70,00
Option front with door HKD 2.2 round glass			Price on request

Available variants:

Front variants:			
Door frame, black		SET209421	11258,00
Door frame, stainless steel		SET209422	11350,00
Mounting frame, black		SET209423	11460,00
Mounting frame, stainless steel		SET209424	11680,00

¹compared to EAS: EOS control & display unit, second flush-mount box, connecting cable for control & display unit 2m long, 4x water temperature sensor with sleeve and 2x extension cable 3m long.

Energy efficiency index A +

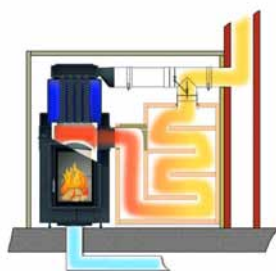

Heat storage mode
with Moritz's flap

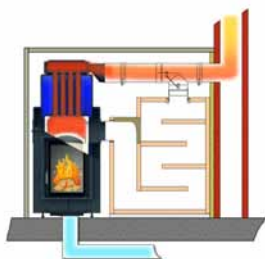

Boiler operation
with Moritz's flap

HKD 2.2 XL SK /h Tunnel + EAS (with Moritz's flap mode)

Set consists of:	Art. No.	No.	Price
HKD 2.2 XL SK/h DF/DF side-opening door flat glass, Tunnel, single glazed for EAS/EOS, with cleaning mechanism		1	
Door frame or mounting frame		2	
Inner lining set for HKD 2.2 XL SK/h Tunnel flat/round		1	
Upper lining HKD 2.2 XL SK/h		1	
Moritz's smoke valve		1	
EAS (see page 245)		1	
Mounting box		1	
Door switch wiring 2 lm		1	
Thermocouple wiring 2 lm		1	
Bus wiring 2 lm		1	
Connecting piece for side/rear smoke outlet ø 180 mm		1	
Smoke pipe connecting piece ø 180 mm Side		1	

Additional options

Add. charge EOS ¹			1267,50
Reduced price for EAS without display			-148,00
Smoke pipe outlet on top ø 180 mm	W043140		0,00
Smoke valve actuator with insulation (10338 and 10329) ² (EOS 6 is required)			717,50
Conversion kit/ extension for cleaning on front	11726		199,50
Conversion kit/extension for cleaning on side	W043135		191,50
Double glazing			320,00
Door lock as revision handle	02429		70,00
Option front with door HKD 2.2 round glass			Price on request

Available variants:

Front variants:			
Door frame, black		SET209438	12072,00
Door frame, stainless steel		SET209439	12164,00
Mounting frame, black		SET209440	12274,00
Mounting frame, stainless steel		SET209441	12494,00

¹compared to EAS: EOS control & display unit, second flush-mount box, connecting cable for control & display unit 2m long, 4x water temperature sensor with sleeve and 2x extension cable 3m long.

²possible only in combination with EOS.

Energy efficiency index A +

HKD 2.2 XL SK /h Tunnel with direct connection incl. EAS

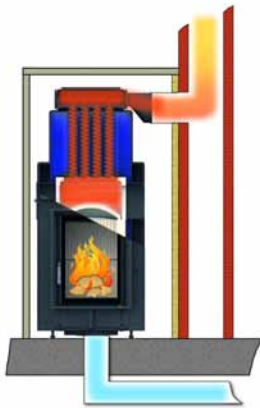

Boiler operation with direct connection

Set consists of:	Art. No.	No.	Price
HKD 2.2 XL SK/h DF/DF side-opening door flat glass, Tunnel , single glazed for EAS/EOS, with cleaning mechanism		1	
Door frame or mounting frame		2	
Inner lining set for HKD 2.2 XL SK/h Tunnel flat/round		1	
Upper lining HKD 2.2 XL SK/h		1	
EAS (see page 245)		1	
Mounting box		1	
Door switch wiring 2 lm		1	
Thermocouple wiring 2 lm		1	
Bus wiring 2 lm		1	
Connecting piece for side/rear smoke outlet ø 180 mm		1	

Additional options			
Add. charge EOS ¹			1267,50
Reduced price for EAS without display			-148,00
Smoke pipe outlet on top ø 180 mm	W043140		0,00
Conversion kit/ extension for cleaning on front	11726		199,50
Conversion kit/extension for cleaning on side	W043135		191,50
Double glazing			320,00
Door lock as revision handle	02429		70,00
Option front with door HKD 2.2 round glass			Price on request

Available variants:

Front variants:			
Door frame, black		SET209443	11615,50
Door frame, stainless steel		SET209444	11707,50
Mounting frame, black		SET209445	11817,50
Mounting frame, stainless steel		SET209446	12037,50

¹compared to EAS: EOS control & display unit, second flush-mount box, connecting cable for control & display unit 2m long, 4x water temperature sensor with sleeve and 2x extension cable 3m long.

Energy efficiency index A +

HKD 7 SK Tunnel + EAS (with Moritz's flap mode)

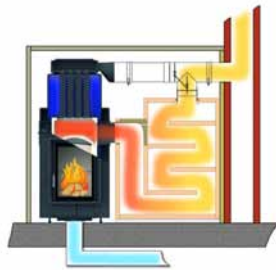

Heat storage mode
with Moritz's flap

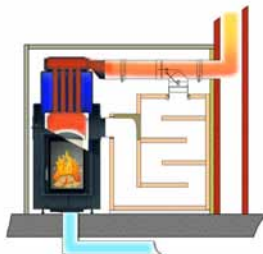

Boiler operation
with Moritz's flap

Set consists of:	Art. No.	No.	Price
HKD 7 SK DF/DF side-opening door flat glass, Tunnel single glazed for EAS/EOS, with cleaning mechanism		1	
Door frame or mounting frame		2	
Inner lining set for HKD 7 SK Tunnel		1	
Upper lining HKD 7 SK		1	
Moritz's smoke valve		1	
EAS (see page 245)		1	
Mounting box		1	
Door switch wiring 2 lm		1	
Thermocouple wiring 2 lm		1	
Bus wiring 2 lm		1	
Connecting piece for side/rear smoke outlet ø 180 mm		1	
Smoke pipe connecting piece ø 180 mm Side		1	

Additional options

Add. charge EOS ¹			1267,50
Reduced price for EAS without display			-148,00
Smoke pipe outlet on top ø 180 mm	W043140		0,00
Smoke valve actuator with insulation (10338 and 10329) ² (EOS 6 is required)			717,50
Conversion kit/ extension for cleaning on front	11726		199,50
Conversion kit/extension for cleaning on side	W043135		191,50
Conversion kit for cleaning on top including push-in handle	BSO5000-123		212,00
Double glazing			320,00

Available variants:

Front variants:			
Door frame, black		SET213006	13312,00
Mounting frame, black		SET213007	13284,00

¹compared to EAS: EOS control & display unit, second flush-mount box, connecting cable for control & display unit 2m long, 4x water temperature sensor with sleeve and 2x extension cable 3m long.

²possible only in combination with EOS.

Energy efficiency index A +

HKD 7 SK Tunnel with direct connection incl. EAS

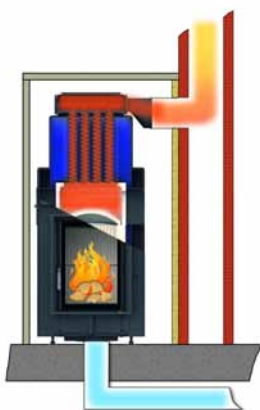

Boiler operation with direct connection

Set consists of:	Art. No.	No.	Price
HKD 7 SK DF/DF side-opening door flat glass, Tunnel single glazed for EAS/EOS, with cleaning mechanism		1	
Door frame or mounting frame		2	
Inner lining set for HKD 7 SK Tunnel		1	
Upper lining HKD 7 SK		1	
EAS (see page 245)		1	
Mounting box		1	
Door switch wiring 2 lm		1	
Thermocouple wiring 2 lm		1	
Bus wiring 2 lm		1	
Connecting piece for side/rear smoke outlet ø 180 mm		1	

Additional options			
Add. charge EOS ¹			1267,50
Reduced price for EAS without display			-148,00
Smoke pipe outlet on top ø 180 mm	W043140		0,00
Conversion kit/ extension for cleaning on front	11726		199,50
Conversion kit/extension for cleaning on side	W043135		191,50
Conversion kit for cleaning on top including push-in handle	BSO5000-123		212,00
Double glazing			320,00

Available variants:

Front variants:			
Door frame, black		SET213008	12855,50
Mounting frame, black		SET213009	12827,50

¹compared to EAS: EOS control & display unit, second flush-mount box, connecting cable for control & display unit 2m long, 4x water temperature sensor with sleeve and 2x extension cable 3m long.

Energy efficiency index A +



Stil-Kamin Tunnel 51/67 ST/DT, single glazing, with top-mount boiler

Set consists of:	Art. No.	No.	Price
Stil-Kamin Tunnel , 51/67 ST/DT, single glazing		1	
Door frame or mounting frame		2	
Chamotte lining set Stil Tunnel 51/67		1	
ISO upper lining / deflection		1	
Top-mount boiler		1	

Additional options			
EAS (see page 245)			1706,50
Reduced price for EAS without display			-148,00
EOS (see page 245)			2974,00
Smoke pipe adapter for horizontal/vertical outlet	BSK7000-129		405,50
Counterweights for non-self closing door	49097		46,50
Double glazing			578,00
Revision handle	02426		130,00
Version with 2 lifting doors upon request			

Available variants:

Front variants:			
Door frame, black		SET210564	9203,50
Door frame, black DT Mounting frame, black ST 50 mm		SET210566	9203,50
Door frame, black DT Mounting frame, black ST 70 mm		SET210568	9267,50

Energy efficiency index A +

flat

Tunnel

Additional door DHT

Eck

Heating Center

Boiler

Architektur-Kamin Tunnel 38/86, lifting/tilting door, with top-mount boiler



Set consists of:	Art. No.	No.	Price
AK Tunnel 38/86, ST/KT, single glazing		1	
Door frame or mounting frame		2	
Inner lining set for Stil AK Tunnel 38/86		1	
ISO upper lining / deflection		1	
Top-mount boiler AK 38/86		1	

Additional options			
EAS (see page 245)			1561,50
Reduced price for EAS without display			-148,00
EOS (see page 245)			2829,00
Smoke pipe adapter for horizontal/vertical outlet	BSK7000-129		405,50
Exchange connecting piece ø 180 mm	I058043		77,00
Double glazing (also one side only available on request)			640,00
Counterweights for non-self closing door	49097		46,50
Version with 2 lifting doors upon request			

Available variants:

Front variants:			
Door frame, black		SET208767	10272,00
Mounting frame, black, 50 mm		SET208769	10179,00
Mounting frame, black, 70 mm		SET208924	10220,00

Energy efficiency index A +





Architektur-Kamin Tunnel 45/101, ST/KT, with top-mount boiler

Set consists of:	Art. No.	No.	Price
Fireplace waterbearing Tunnel AK 45/101, single glazing		1	
Door frame or mounting frame		2	
Inner lining set for Fireplace waterbearing Tunnel 45/101		1	
ISO upper lining / deflection		1	
Top-mount boiler AK 45/101		1	

Additional options			
EAS (see page 245)			1561,50
Reduced price for EAS without display			-148,00
EOS (see page 245)			2829,00
Smoke pipe adapter for horizontal outlet	I019490		299,00
Double glazing			810,00
Counterweights for non-self closing door	49097		46,50
Version with 2 lifting doors upon request			

Available variants:

Front variants:			
Door frame, black		SET208281	10736,00
Mounting frame, black, 50 mm		SET208283	10640,00
Mounting frame, black, 70 mm		SET208926	10712,00

Energy efficiency index A +

flat

Tunnel

Additional door DHT

Eck

Heating Center

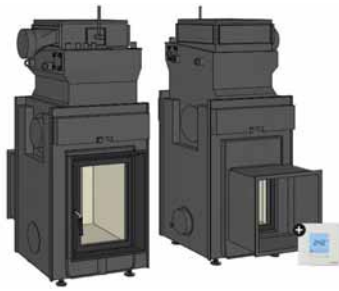

Heat storage mode with Moritz's flap



Boiler operation with Moritz's flap

HKD 2.2 SK + EAS DHT M (with Moritz's flap mode)

Set consists of:	Art. No.	No.	Price
HKD 2.2 SK DF side-opening door flat glass, single glazed for EAS/EOS, with cleaning mechanism DHT M		1	
Door frame or mounting frame		1	
Inner lining set for HKD 2.2 SK flat/round		1	
Upper lining HKD 2.2 SK		1	
Moritz's smoke valve		1	
EAS (see page 245)		1	
Mounting box		1	
Door switch wiring 2 lm		1	
Thermocouple wiring 2 lm		1	
Bus wiring 2 lm		1	
Connecting piece for side/rear smoke outlet ø 180 mm		1	
Smoke pipe connecting piece ø 180 mm Side		1	

Additional options

Add. charge EOS ¹			1267,50
Reduced price for EAS without display			-148,00
Smoke pipe outlet on top ø 180 mm	W043140		0,00
Smoke valve actuator with insulation (10338 and 10329) ²			717,50
Double glazing			160,00
Revision handle	02429		70,00
Option front with door HKD 2.2 round glass			Price on request

Available variants:

Front variants:			
Door frame, black		SET212281	11436,00
Door frame, stainless steel		SET212282	11482,00
Mounting frame, black		SET212283	11537,00
Mounting frame, stainless steel		SET212284	11647,00

¹compared to EAS: EOS control & display unit, second flush-mount box, connecting cable for control & display unit 2m long, 4x water temperature sensor with sleeve and 2x extension cable 3m long.

²possible only in combination with EOS.

Energy efficiency index A +

flat

Tunnel

Additional door DHT

Boiler

Eck

Heating Center

HKD 2.2 SK + EAS DHT M with direct connection

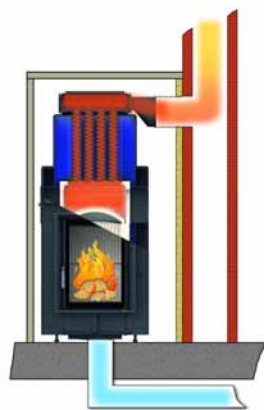
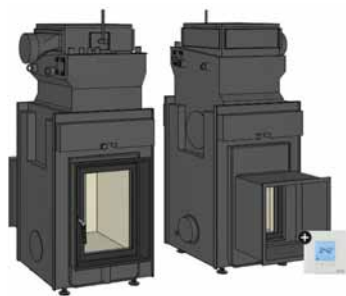

Boiler operation with direct connection

Set consists of:	Art. No.	No.	Price
HKD 2.2 SK DF side-opening door flat glass, single glazed for EAS/EOS DHT M		1	
Door frame or mounting frame		1	
Inner lining set for HKD 2.2 SK flat/round		1	
Upper lining HKD 2.2 SK		1	
EAS (see page 245)		1	
Mounting box		1	
Door switch wiring 2 lm		1	
Thermocouple wiring 2 lm		1	
Bus wiring 2 lm		1	
Connecting piece for side/rear smoke outlet \varnothing 180 mm		1	

Additional options			
Add. charge EOS ¹			1267,50
Reduced price for EAS without display			-148,00
Smoke pipe outlet on top \varnothing 180 mm	W043140		0,00
Double glazing			160,00
Revision handle	02429		70,00
Option front with door HKD 2.2 round glass			Price on request

Available variants:

Front variants:			
Door frame, black		SET212286	10979,50
Door frame, stainless steel		SET212287	11025,50
Mounting frame, black		SET212288	11080,50
Mounting frame, stainless steel		SET212289	11190,50

¹compared to EAS: EOS control & display unit, second flush-mount box, connecting cable for control & display unit 2m long, 4x water temperature sensor with sleeve and 2x extension cable 3m long.

Energy efficiency index A +

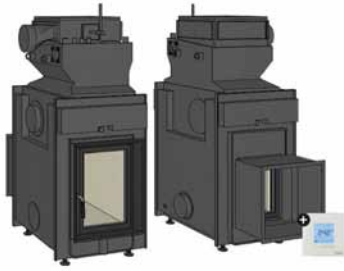

Heat storage mode
with Moritz's flap



Boiler operation
with Moritz's flap

HKD 2.2 XL SK/h + EAS DHT M (with Moritz's flap mode)

Set consists of:	Art. No.	No.	Price
HKD 2.2 XL SK/h DF side-opening door flat glass , single glazed for EAS/EOS with cleaning mechanism DHT M		1	
Door frame or mounting frame		1	
Inner lining set for HKD 2.2 XL SK /h flat/round		1	
Upper lining HKD 2.2 XL SK /h		1	
Moritz's smoke valve		1	
EAS (see page 245)		1	
Mounting box		1	
Door switch wiring 2 lm		1	
Thermocouple wiring 2 lm		1	
Bus wiring 2 lm		1	
Connecting piece for side/rear smoke outlet ø 180 mm		1	
Smoke pipe connecting piece ø 180 mm Side		1	

Additional options

Add. charge EOS ¹			1267,50
Reduced price for EAS without display			-148,00
Rauchrohrabgang oben ø 180 mm	W043140		0,00
Smoke valve actuator with insulation (10338 and 10329)			717,50
Double glazing			160,00
Revision handle	02429		70,00
Option front with door HKD 2.2 round glass			Price on request

Available variants:

Front variants:			
Door frame, black		SET212291	11797,00
Door frame, stainless steel		SET212292	11843,00
Mounting frame, black		SET212293	11898,00
Mounting frame, stainless steel		SET212294	12008,00

¹compared to EAS: EOS control & display unit, second flush-mount box, connecting cable for control & display unit 2m long, 4x water temperature sensor with sleeve and 2x extension cable 3m long.

²possible only in combination with EOS.

Energy efficiency index A +

HKD 2.2 XL SK/h + EAS DHT M with direct connection

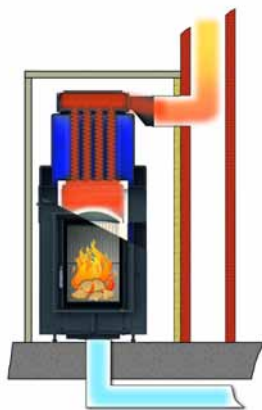
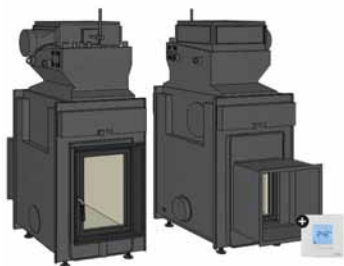

Boiler operation with direct connection

Set consists of:	Art. No.	No.	Price
HKD 2.2 XL SK/h DF side-opening door flat glass , single glazed for EAS/EOS with cleaning mechanism DHT M		1	
Door frame or mounting frame		1	
Inner lining set for HKD 2.2 XL SK /h flat/round		1	
Upper lining HKD 2.2 XL SK /h		1	
EAS (see page 245)		1	
Mounting box		1	
Door switch wiring 2 lm		1	
Thermocouple wiring 2 lm		1	
Bus wiring 2 lm		1	
Connecting piece for side/rear smoke outlet \varnothing 180 mm		1	

Additional options			
Add. charge EOS ¹			1267,50
Reduced price for EAS without display			-148,00
Smoke pipe outlet on top \varnothing 180 mm	W043140		0,00
Double glazing			160,00
Revision handle	02429		70,00
Option front with door HKD 2.2 round glass			Price on request

Available variants:

Front variants:			
Door frame, black		SET212296	11340,50
Door frame, stainless steel		SET212297	11386,50
Mounting frame, black		SET212298	11441,50
Mounting frame, stainless steel		SET212299	11551,50

¹compared to EAS: EOS control & display unit, second flush-mount box, connecting cable for control & display unit 2m long, 4x water temperature sensor with sleeve and 2x extension cable 3m long.

Energy efficiency index A +



Corner fireplace waterbearing 42/57/30 left side, side-opening door

Set consists of:	Art. No.	No.	Price
Corner fireplace waterbearing 42/57/30 left side, side-opening door two-piece ceramic glass, outlet \varnothing 180 mm		1	
Door frame or mounting frame		1	
Inner lining set, bright, for Kamin-Kessel Eck 42/57/30 l/r		1	

Additional options			
EAS (see page 245)			1561,50
Reduced price for EAS without display			-148,00
EOS (see page 245)			2829,00

Available variants:

Front variants:			
Mounting frame, black 50 mm		SET213018	5926,00
Door frame		SET213067	5861,50

Energy efficiency index A +

Corner fireplace waterbearing 42/57/30 right side, side-opening door



Set consists of:	Art. No.	No.	Price
Corner fireplace waterbearing 42/57/30 right side, side-opening door two-piece ceramic glass, outlet \varnothing 180 mm		1	
Door frame or mounting frame		1	
Inner lining set, bright, for Kamin-Kessel Eck 42/57/30 l/r		1	

Additional options			
EAS (see page 245)			1561,50
Reduced price for EAS without display			-148,00
EOS (see page 245)			2829,00

Available variants:

Front variants:			
Mounting frame, black 50 mm		SET213019	5926,00
Door frame		SET213068	5861,50

Energy efficiency index A +

Corner fireplace waterbearing 45/67/44 left side, lifting door



Set consists of:	Art. No.	No.	Price
Corner fireplace waterbearing 45/67/44 left side, lifting door two-piece ceramic glass, outlet ø 180 mm		1	
Mounting frame		1	
Inner lining set, bright, for Kamin-Kessel Eck 45/67/44 l/r		1	
ISO upper lining		1	

Additional options			
EAS (see page 245)			1561,50
Reduced price for EAS without display			-148,00
EOS (see page 245)			2829,00
Counterweights for non-self closing door	49097		46,50
Conversion kit/ extension for cleaning on front	11726		199,50
Conversion kit/extension for cleaning on side	W043135		191,50
Conversion kit for cleaning on top including push-in handle	BSK2000-201		209,50

Available variants:

Front variants:			
Mounting frame, black, 50 mm		SET212984	7928,50
Mounting frame, black, 70 mm		SET212986	8064,00

Energy efficiency index A +



Corner fireplace waterbearing 45/67/44 right side, lifting door

Set consists of:	Art. No.	No.	Price
Corner fireplace waterbearing 45/67/44 right side, lifting door two-piece ceramic glass, outlet ø 180 mm		1	
Mounting frame		1	
Inner lining set, bright, for Kamin-Kessel Eck 45/67/44 l/r		1	
ISO upper lining		1	

Additional options			
EAS (see page 245)			1561,50
Reduced price for EAS without display			-148,00
EOS (see page 245)			2829,00
Counterweights for non-self closing door	49097		46,50
Conversion kit/ extension for cleaning on front	11726		199,50
Conversion kit/extension for cleaning on side	W043135		191,50
Conversion kit for cleaning on top including push-in handle	BSK2000-201		209,50

Available variants:

Front variants:			
Mounting frame, black, 50 mm		SET212989	7928,50
Mounting frame, black, 70 mm		SET212991	8064,00



Energy efficiency index A +





	Art. No.	Infos	Designation	Price
Accessories Boiler technology				
	00717.1	<input type="checkbox"/>	Tiled stove pump unit	764,50
	00719.1	<input type="checkbox"/>	Pump control incl. 2 pieces PT 1000	162,00
	902350	<input type="checkbox"/>	Safety valve 651 HN 1/2"	36,00





BHZ - BRUNNER Heating Center





Heating Center 3.0



	Art. No.	info	Designation	Price
Heating Center BHZ 15-50 kW				
For approved hydraulic diagrams, refer to Brunner Hydraulic Manual (https://www.brunner.de/produktdownloads/kessel-waermepumpen/00_brunner_hydraulik-handbuch_5_2022.pdf)				
		■	Heating Center basic module - Hydraulic box, ready for connection, for combination with the BRUNNER system storage tank. Basic module with: - System controller with 5,7"-VGA-Touch-Display - Set of hoses for connection with storage tank, with thermal insulation	
	V009001-02		Basic module BHZ 3.0 with touch-display	5000,00
		■	Heating Center basic module - Hydraulic box, ready for connection, for combination with the BRUNNER system storage tank. Basic module with: - System controller without 5,7"-VGA-Touch-Display - Set of hoses for connection with storage tank, with thermal insulation - Blind cover for Heating Center	
	V009001-01		BHZ 3.0 basic module without touch-display	3688,50
■ must be ordered ■ make a choice □ optional				



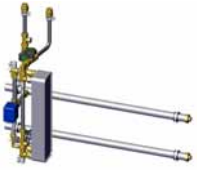
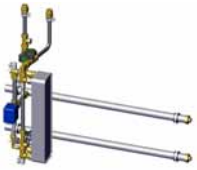

	Art. No.	info	Designation	Price
Heat generator				
Solid fuel module				
	V009104	■	Tiled stove circuit - motorized return flow increase - incl. integrated power measurement	1017,00
Return flow for solid fuel boiler / Collector pipe Heat generator				
	V009098	■	Return flow for solid fuel boiler as well as collector for heat generators * without power measurement *for example: oil/gas boiler etc.	245,50
	V009008-02	■	Return flow for solid fuel boiler as well as collector for heat generators * with power measurement - System storage connection to hydraulic box on the left - connection oil/gas boiler etc. right side to the hydraulic box *for example: oil/gas boiler etc.	506,00
	V009008-01	■	Return flow for solid fuel boiler as well as collector for heat generators * with power measurement - System storage connection to hydraulic box on the right - connection oil/gas boiler etc. left side to the hydraulic box *for example: oil/gas boiler etc.	506,00
■ must be ordered ■ make a choice □ optional				

	Art. No.	info	Designation	Price
Heat generator				
Solar module				
	V009005	<input type="checkbox"/>	Solar module with system separation - Collector sensor by customer - incl. integrated power measurement - Solar primary pump: Wilo Yonos Para ST 15/13 PWM 2, 130 - Solar secondary pump Wilo Yonos Para 15/6 PWM 1, 130	2287,00
Photovoltaic connection				
	V009340-01	<input type="checkbox"/>	Photovoltaic connection for BHZ 3.0 for hot water preparation and heating support incl. - 2 directional energy meter - Electrical screw-in heater 9 kW with safety temperature limiter - Tube set for BHZ 3.0 - Electronic Power Controller Upgradeable for all systems with BHZ 3.0 + System Storage 3.0.	2392,00
ATTENTION: The PV module requires the use of the fresh water module (not possible with hot water storage- module)				
Elektro-Zentralheizungsmodul				
	V009340-03	<input type="checkbox"/>	Electric central heating module BHZ 3.0 for hot water and heating incl. - Electric screw-in heater 9 kW with STB (safety temperature limiter) - Tube set for BHZ 3.0 - Electronic power controller Upgradeable for all systems with BHZ 3.0 + System Storage 3.0.	1330,00
CAUTION: Precondition for the electro- central heating module is the use of the fresh water module (not with hot water storage module possible)				
<input checked="" type="checkbox"/> must be ordered <input checked="" type="checkbox"/> make a choice <input type="checkbox"/> optional				
Heat pump-integration				
	V009390	<input type="checkbox"/>	Integration of air-water heat pump Brunner BWP 3/13 only for Brunner heat pump BWP	1362,50
	V009380-01	<input type="checkbox"/>	Einbindung Fremdwärmepumpe bis 20 kW	1118,00
Note				
- when using heat pump connection, it is not possible to integrate solar module V009005 - when using heat pumps integration, only the system memory 750 liters Art-No. V009800 or 1000 liters Art. No. V009850 can be used - Heat pump integration V009390 can only be retrofitted to BHZ 3.0 if the above mentioned points are given				
<input checked="" type="checkbox"/> must be ordered <input checked="" type="checkbox"/> make a choice <input type="checkbox"/> optional				



	Art. No.	info	Designation	Price
Heat generator				



Electric heaters				
	900822	<input type="checkbox"/>	<p>Electric immersion heater 9 kW with safety temperature limit</p> <p>Immersion depth: 810 mm Non-heated length: 100 mm Thread size: G 1 1/2 " Degree of protection: IP 64 Mounting position: horizontal or vertical from top Star connection, suitable for continuous operation</p> <p>Suitable for installation in Brunner System Storage 3.0 and all commercially available buffer tanks</p>	396,50
	901106	<input type="checkbox"/>	<p>Electric screw in heater 6 kW with safety temperature limiter</p> <p>Immersion depth: 480 mm Length unheated: 100 mm Screw head: G 1 1/2 " Protection class: IP 64 Installation: horizontal and vertical from above Star circuit, suitable for continuous operation</p> <p>Suitable for installation in all Brunner system storages and all standard buffers</p>	394,00
<input checked="" type="checkbox"/> must be ordered <input checked="" type="checkbox"/> make a choice <input type="checkbox"/> optional				

	Art. No.	info	Designation	Price
Heat consumer				
Fresh water module				
	V009490	■	<p>Fresh water module 40 l/min: Stainless steel plate heat exchanger with copper soldering</p> <p>Fresh water module 40 L per minute, for fast and hygienic potable water heating in the flow process. Suitable for use in multiple family homes.</p> <ul style="list-style-type: none"> - incl. integrated power measurement - Typ Wilo Para 15/8/130 PWM - incl. V009310 Insulation fresh water module BHZ - Esbe Vormischventil Typ: VTA 370 	2806,00
	V009530	■	<p>Fresh water module 40 l/min: Stainless steel plate heat exchanger with nickel soldering</p> <p>Fresh water module 40 L per minute, for fast and hygienic potable water heating in the flow process. Suitable for use in multiple family homes.</p> <ul style="list-style-type: none"> - incl. integrated power measurement - Typ Wilo Para 15/8/130 PWM - incl. V009310 Insulation fresh water module BHZ - Esbe Vormischventil Typ: VTA 370 	5566,50
	V009135	□	<p>Circulation connection incl. pump in combination with fresh water station</p> <p>Circulation pump Wilo ZRS 15/4. (possible only in combination with fresh water module)</p>	250,00
Hot water loading module				
	V005045	■	<p>Hot water loading module</p> <p>Hot water loading module for external hot water storage tank. For use in single-family houses or twin housings.</p>	683,50
■ must be ordered ■ make a choice □ optional				



	Art. No.	info	Designation	Price
Heat consumer				
Heating circuit module 1				
	V009102	<input checked="" type="checkbox"/>	Mixed heating circuit group 1 with power measurement Heating circuit module with pump Wilo Yonos Para 13/130, e.g. NT-type panel heaters, radiators, convectors or heating pipe systems (underfloor heating or wall-mount heating registers) with power measurement.	1017,00
	V005044	<input checked="" type="checkbox"/>	Mixed heating circuit group 1 without power measurement Heating circuit module with pump Wilo Yonos Para RS 15/6 for outdoor temperature controlled operation with one heating circuit, e.g. NT-type panel heaters, radiators, convectors or heating pipe systems (underfloor heating or wall-mount heating registers) without power measurement.	862,00
Heat consumer				
Heating circuit module 2				
	V009102	<input checked="" type="checkbox"/>	Mixed heating circuit group 2 with power measurement Heating circuit module with pump Wilo Yonos Para 13/130, e.g. NT-type panel heaters, radiators, convectors or heating pipe systems (underfloor heating or wall-mount heating registers) with power measurement.	1017,00
	V005044	<input checked="" type="checkbox"/>	Mixed heating circuit group 2 without power measurement Heating circuit module with pump Wilo Yonos Para RS 15/6 for outdoor temperature controlled operation with one heating circuit, e.g. NT-type panel heaters, radiators, convectors or heating pipe systems (underfloor heating or wall-mount heating registers) without power measurement.	862,00
<input checked="" type="checkbox"/> must be ordered <input checked="" type="checkbox"/> make a choice <input type="checkbox"/> optional				

	Art. No.	info	Designation	Price
Accessories for Heating Center				
	E006004-20	<input type="checkbox"/>	<p>Extension board 'Heating circuits'</p> <p>In wall-mount box. For outdoor temperature controlled operation with 2 additional heating circuits</p> <p>- 2 pcs. surface sensors Pt 1000 for heating circuit flow line, with mounting clamp</p> <p>-incl. connection possibility for 2 heat metering systems in combination with UK 100090-01</p> <p>Connecting cable for data E013005-.. 3-wire required</p>	768,50
	UK100090	<input type="checkbox"/>	<p>Mixed heating circuit group 3,4,5,6, DN 25 without power measurement</p> <p>Heating circuit module with pump Wilo Yonos Para 25/6, for e.g. NT-type panel heaters, radiators, convectors or heating pipe systems (underfloor heating or wall-mount heating registers)</p>	773,50
	UK100090-01	<input type="checkbox"/>	<p>Mixed heating circuit group 3,4,5,6 DN 25 with power measurement</p> <p>Heating circuit group with volume flow metering, with pump Wilo Yonos Para 25/6, for e.g. NT-type panel heaters, radiators, convectors or heating pipe systems (underfloor heating or wall-mount heating registers)</p>	1084,50
	900197	<input type="checkbox"/>	<p>Manifold 2x, DN 25</p> <p>- Manifold with wall mounting bracket, for 2 heating circuit modules, or alternatively for 1 heating circuit module and 1 hot water tank loading module</p> <p>- Flow and Return are thermally separated, with EPP thermal insulation</p>	351,50
	900198	<input type="checkbox"/>	<p>Manifold 3x, DN 25</p> <p>- Manifold with wall mounting bracket, for 3 heating circuit modules, or alternatively for 2 pcs. heating circuit module and 1 pc. hot water tank loading module</p> <p>- Flow and Return are thermally separated, with EPP thermal insulation</p>	422,50
	900199	<input type="checkbox"/>	<p>Manifold 5x, DN 25</p> <p>- Manifold with wall mounting bracket, for 5 heating circuit modules, or alternatively for 4 pcs. heating circuit module and 1 pc. hot water tank loading module</p> <p>- Flow and Return are thermally separated, with EPP thermal insulation</p>	1075,50
	900288	<input type="checkbox"/>	<p>Power inverter + battery box NV500/1000</p> <p>For uninterrupted operation (emergency power supply) during power outages. Suitable for typical 12 Volt lead batteries for automotive or solar applications with a capacity between 65 Ah and 125 Ah (the battery is not supplied).</p>	757,00
	SET211001	<input checked="" type="checkbox"/>	<p>Insulating shell kit</p> <p>consists of 2 collector pipe insulating pieces</p>	41,00
<input checked="" type="checkbox"/> must be ordered <input checked="" type="checkbox"/> make a choice <input type="checkbox"/> optional				



	Art. No.	info	Designation	Price
Accessories for Heating Center				
		<input type="checkbox"/>	Mounting box Flush-mount box for installation of additional touchsensitive display.	
	900001		Standard mounting box Dimensions L x W x D = 159 x 159 x 75 mm	13,00
	E004007-01		Mounting box for dry wall installation Dimensions L x W x D = 165 x 165 x 72 mm	83,50
		<input type="checkbox"/>	Connection wiring Touch-Display universal connection wiring (CAN-Bus) for data exchange between wood and pellet boilers, BHZ Heating Center and all extension boards with additional Touch-Display (5 wires)	
	E013001-2		Connection wiring 2 m	23,50
	E013001-3		Connection wiring 3 m	25,50
	E013001-4		Connection wiring 4 m	28,50
	E013001-5		Connection wiring 5 m	31,00
	E013001-7		Connection wiring 7 m	37,50
	E013001-10		Connection wiring 10 m	45,00
			Connection wiring > 10 m up to max. 30 m by metre	upon request
		<input type="checkbox"/>	Connection wiring Data universal connection wiring (CAN-Bus) for data exchange between wood and pellet boilers, BHZ Heating Center and all extension boards (3 wires)	
	E013005-1		Connection wiring 0,7 m	18,00
	E013005-2		Connection wiring 2 m	21,00
	E013005-3		Connection wiring 3 m	23,50
	E013005-4		Connection wiring 4 m	25,50
	E013005-5		Connection wiring 5 m	29,00
	E013005-7		Connection wiring 7 m	33,50
	E013005-10		Connection wiring 10 m	43,00
			Connection wiring > 10 m up to max. 30 m by metre	upon request
■ must be ordered ■ make a choice □ optional				

	Art. No.	info	Designation	Price
Accessories for Heating Center				
		<input type="checkbox"/>	Extension wiring for temperature sensor extension wiring with screen, for Pt 1000 temperature sensors	
	E013013-01		Extension wiring 3 m	35,00
	E013013-02		Extension wiring 5 m	40,00
	E013013-03		Extension wiring 10 m	58,00
	E013013-04		Extension wiring 15 m	72,00
	10339	<input type="checkbox"/>	Temperature sensor with immersion sleeve for variable use, e.g. as boiler sensor for existing solid fuel boilers Temperature sensor Pt1000 with immersion sleeve DN 15 (1/2")	37,50
	900205	<input type="checkbox"/>	Temperature sensor with clamping band for variable use, e.g. as boiler sensor for existing solid fuel boilers Temperature sensor Pt1000 with clamping band as contact sensor	14,50
	V009181	<input type="checkbox"/>	Passage from 22 ferrule/1" male	14,00
■ must be ordered ■ make a choice □ optional				

	Art. No.	Infos	Designation	Price
System storage				
		<input type="checkbox"/>	System storage The system storage (buffer tank) is enabled for laminar loading and optimized for operation with renewable heating sources. - Efficient thermal insulation from 100 mm Polyester mats (thermal conductivity index WLG = 0,35) - Incl. 8 pcs. ball valves - Connection option for Brunner air-water heat pump BWP 3/13	
	V009800		System storage 750 l	2175,50
	V009850		System storage 1000 l	2385,00



Accessories System storage				
	900098		Automatic top-of-tank breather (for all system storage tanks)	14,00
	V005363		Horizontal venting pipe for system storage 750l und 1000l	25,00
	V006068		Horizontal venting pipe for system storage 1500l	26,00
	V008074		Horizontal venting pipe for system storage 2000 l	27,50



System storage				
		<input type="checkbox"/>	System storage The system storage (buffer tank) is enabled for laminar loading and optimized for operation with renewable heating sources. - Efficient thermal insulation from 100 mm Polyester mats (thermal conductivity index WLG = 0,35) - Incl. 8 pcs. ball valves	
	V006070		System storage 1500 l	2959,50
	V008080		System storage 2000 l	3608,50

Accessories System storage				
	900098		Automatic top-of-tank breather (for all system storage tanks)	14,00
	V005363		Horizontal venting pipe for system storage 750l und 1000l	25,00
	V006068		Horizontal venting pipe for system storage 1500l	26,00
	V008074		Horizontal venting pipe for system storage 2000 l	27,50

	Art. No.	Infos	Designation	Price
Standard storage				
		<input type="checkbox"/>	Standard storage The standard storage (buffer tank) for extension of storage volume.	
	V007023		Standard storage 750 l	1239,50
	V005071		Standard storage 1000 l	1587,50
	V006048		Standard storage 1500 l	2111,50
	V008050		Standard storage 2000 l	2507,50

System storage tank and Standard storage tank can be hydraulically connected by using a set of connecting hoses (see Accessories for storage tanks). Both tanks must be of the same size and volume.

Accessories for storage tanks				
		<input type="checkbox"/>	Flexible hose connection kit insulated for hydraulic connection between System storage tank and Standard storage tank. Both tanks must be of the same size and volume.	
	900122K		Flexible hose connection kit insulated consisting of: - 8 pcs. double threaded fitting with gasket - 4 pcs. flexible hose, L=170 mm	251,50
	900123K		Flexible hose connection kit insulated consisting of: - 8 pcs. double threaded fitting with gasket - 4 pcs. flexible hose, L=450 mm	282,50
	SET211000	<input checked="" type="checkbox"/>	Ball valves insulation KIT consisting of 4 pcs. insulation for ball valve DN 32 with ball valve extension 4 pcs. insulation for ball valve DN 25 with ball valve extension	194,00
<input checked="" type="checkbox"/> must be ordered <input checked="" type="checkbox"/> make a choice <input type="checkbox"/> optional				

	Art. No.	Infos	Designation	Price
Free installation of the extension board basic				
For approved hydraulic diagrams, refer to Brunner Hydraulic Manual				
(https://www.brunner.de/produktdownloads/kessel-waermepumpen/00_brunner_hydraulik-handbuch_5_2022.pdf)				
	E006004-10	<input checked="" type="checkbox"/>	Extension board 'Basic' In wall-mount box. For outdoor temperature controlled operation of 2 mixed heating circuits, hot water storage tank loading, incl. necessary temperature sensors (Data wiring with 3 wires is necessary for connection with boiler). - 3 pcs. storage tank sensor Pt 1000 with sleeve DN 15 (1/2") - 2 pcs. surface sensors Pt 1000 for heating circuit flow line, with mounting clamp - 1 pc. hot water storage tank temperature sensor Pt 1000 with sleeve DN 15 (1/2") - 1 pc. outdoor sensor Pt 1000 Precondition for this version: Boiler operation with EOS 6	932,00
Hydraulic components				
	UK100090	<input type="checkbox"/>	Mixed heating circuit 1-6, DN 25 Heating circuit module with pump Wilo Yonos Para 25/6, for e.g. NT-type panel heaters, radiators, convectors or heating pipe systems (underfloor heating or wall-mount heating registers)	773,50
	UK100100	<input type="checkbox"/>	Hot water storage external loading module, DN Hot water storage loading module with pump Wilo Yonos Para 25/6, for loading of a new or already existing hot water storage tank in case of high demand for domestic hot water	527,00
<input checked="" type="checkbox"/> must be ordered <input checked="" type="checkbox"/> make a choice <input type="checkbox"/> optional				

	Art. No.	Infos	Designation	Price
Accessories for free installation				
	900197	<input type="checkbox"/>	Manifold 2x, DN 25 - Manifold with wall mounting bracket, for 2 heating circuit modules, or alternatively for 1 pc. heating circuit module and 1 pc. hot water tank loading module - Flow and Return are thermally separated, with EPP thermal insulation	351,50
	900198	<input type="checkbox"/>	Manifold 3x, DN 25 - Manifold with wall mounting bracket, for 3 heating circuit modules, or alternatively for 2 pcs. heating circuit module and 1 pc. hot water tank loading module - Flow and Return are thermally separated, with EPP thermal insulation	422,50
	900199	<input type="checkbox"/>	Manifold 5x, DN 25 - Manifold with wall mounting bracket, for 5 heating circuit modules, or alternatively for 4 pcs. heating circuit module and 1 pc. hot water tank loading module - Flow and Return are thermally separated, with EPP thermal insulation	1075,50
	00717.1	<input type="checkbox"/>	Tiled stove pump unit	764,50
■ must be ordered ■ make a choice □ optional				

Standard storage

from
page
293

	Art. No.	Infos	Designation	Price
Free Installation extension board 'Heating circuits'				
	E006004-20	<input type="checkbox"/>	Extension board 'Heating circuits' In wall-mount box. For outdoor temperature controlled operation with 2 additional heating circuits - 2 pcs. surface sensors Pt 1000 for heating circuit flow line, with mounting clamp - incl. connection possibility for 2 heat metering systems in combination with UK 100090-01 - Connecting cable for data E013005-.. 3-wire required Precondition for this version: Boiler operation with EOS 6, Extension board 'Basic'	768,50
Hydraulic components				
	UK100090	<input type="checkbox"/>	Mixed heating circuit 1-6, DN 25 Heating circuit module with pump Wilo Yonos Para 25/6, for e.g. NT-type panel heaters, radiators, convectors or heating pipe systems (underfloor heating or wall-mount heating registers)	773,50
	UK100090-01	<input type="checkbox"/>	Mixed heating circuit group 3,4,5,6 DN 25 with power measurement Heating circuit group with volume flow metering, with pump Wilo Yonos Para 25/6, for e.g. NT-type panel heaters, radiators, convectors or heating pipe systems (underfloor heating or wall-mount heating registers)	1084,50
Accessories for free installation				
	900197	<input type="checkbox"/>	Manifold 2x, DN 25 - Manifold with wall mounting bracket, for 2 heating circuit modules, or alternatively for 1 pc. heating circuit module and 1 pc. hot water tank loading module - Flow and Return are thermally separated, with EPP thermal insulation	351,50
	900198	<input type="checkbox"/>	Manifold 3x, DN 25 - Manifold with wall mounting bracket, for 3 heating circuit modules, or alternatively for 2 pcs. heating circuit module and 1 pc. hot water tank loading module - Flow and Return are thermally separated, with EPP thermal insulation	422,50
	900199	<input type="checkbox"/>	Manifold 5x, DN 25 - Manifold with wall mounting bracket, for 5 heating circuit modules, or alternatively for 4 pcs. heating circuit module and 1 pc. hot water tank loading module - Flow and Return are thermally separated, with EPP thermal insulation	1075,50
■ must be ordered ■ make a choice □ optional				

	Art. No.	Infos	Designation	Price
Free installation of the extension board of power registration for heat generator				
	E006004-40	<input type="checkbox"/>	<p>Extension board 'Performance'</p> <p>In wall-mount box. For heat metering and balancing of a connected additional heating, e.g. oil/gas boiler or heat pump.</p> <p>- Connecting cable for data E013005-.. 3-wire required</p> <p>Precondition for this version: Boiler operation with EOS 6, Extension board 'Basic'</p> <p>If only the performance of the boiler should be recorded the extension board of Power registration can be connected directly to the EOS without the extension board Basic (EWP Basis).</p>	753,00



Hydraulic components				
		<input type="checkbox"/>	Performance Kit	
	900202		<p>for measurement of heat quantity</p> <p>Set capacity up to 15 kW</p> <p>consists of:</p> <ul style="list-style-type: none"> - flowmeter DN 15 - 2 contact sensors with clamping band 	188,00
	900203		<p>Set capacity 30-50 kW</p> <p>consisting of:</p> <ul style="list-style-type: none"> - Flowmeter DN 20 - 2 contact sensors with clamping band 	206,50
<input checked="" type="checkbox"/> must be ordered <input checked="" type="checkbox"/> make a choice <input type="checkbox"/> optional				

	Art. No.	Infos	Designation	Price
Extension board for tiled stove performance metering				
	E006004-70	<input type="checkbox"/>	<p>Extension board for tiled stove performance metering</p> <ul style="list-style-type: none"> - Wall-mount box - 2 pcs. surface temperature sensor Pt 1000 - Extension kit for power measurement, with Huba sensor 5.0-85 l/min <p>- Power metering and balancing of an additionally connected heat generator or receiver is possible</p> <p>Caution: Combination is possible only with BRUNNER tiled stove pump unit (Art. No. 00717.1)</p> <p>Connecting cable for data E013005-... 3-wire required</p> <p>Precondition for this version: Boiler operation with EOS 6, Extension board 'Basic'</p> <p>If only the performance of the boiler should be recorded the extension board of Power registration can be connected directly to the EOS without the extension board Basic (EWP Basis).</p>	1027,50
<input checked="" type="checkbox"/> must be ordered <input type="checkbox"/> make a choice <input type="checkbox"/> optional				

Tiled stove pump unit

from
page
294

	Art. No.	Infos	Designation	Price
Free installation of the extention board Oil / Gas / Solar				
	E006004-30	<input type="checkbox"/>	<p>Extention board Oil / Gas / Solar</p> <p>In-wall mount box. For intergration of a thermal solar system with separate circuits, and a switch-over function (e.g. zone valve) between hot water storage tank loading or loading of a buffer tank via solar heating. Coil control of a switching valve (e.g. zone valve) for connection of oil or gas heater (requires wiring ofr data transfer between the individual extension boards, with 3 wires)</p> <ul style="list-style-type: none"> - 1 x Pt 1000 temperature sensor for hot water storage with immersion sleeve DN 15 (1/2") - 1 x Pt 1000 boiler temperature sensore with immersion sleeve DN 15 (1/2") - 1 x Pt 1000 collector temperature sensor wiht immersion sleeve DN 15 (1/2") <p>Connecting cable for data E013005-.. 3-wire required</p> <p>Precondition for this version: Boiler operation with EOS 6, Extension board 'Basic'</p>	871,50
<input checked="" type="checkbox"/> must be ordered <input checked="" type="checkbox"/> make a choice <input type="checkbox"/> optional				

	Art. No.	Infos	Designation	Price
Accessories for free installation				
		<input type="checkbox"/>	Connection wiring Data universal connection wiring (CAN Bus) for data exchange between boiler, BHZ and all extension boards..	
	E013005-1		Connection wiring 0,7 m	18,00
	E013005-2		Connection wiring 2 m	21,00
	E013005-3		Connection wiring 3 m	23,50
	E013005-4		Connection wiring 4 m	25,50
	E013005-5		Connection wiring 5 m	29,00
	E013005-7		Connection wiring 7 m	33,50
	E013005-10		Connection wiring 10 m	43,00
			Connection wiring > 10 m up to max. 200 m by metre	
		<input type="checkbox"/>	Extension wiring for temperature sensor extension wiring with screen, for Pt 1000 temperature sensors	
	E013013-01		Extension wiring 3 m	35,00
	E013013-02		Extension wiring 5 m	40,00
	E013013-03		Extension wiring 10 m	58,00
	E013013-04		Extension wiring 15 m	72,00

flat

Tunnel

Additional door DHT

Eck

Heating Center



Iron Dog 01

	Art. No.	No.	Price
Iron Dog 01	50000		2265,50

Energy efficiency class A



	Art. No.	No.	Price
Heat protective panel (backwall) for Iron Dog 01	50130		114,50



Air supply box	Art. No.	No.	Price
Air supply box	K006110		181,50

Aluflex hose	Art. No.	No.	Price
Aluflex hose	N003054		48,00



Iron Dog 02

	Art. No.	No.	Price
Iron Dog 02	K007088		2371,50

Energy efficiency class A

	Art. No.	No.	Price
Heat protective panel (backwall) for Iron Dog 02	K007090		117,00



Air supply box	Art. No.	No.	Price
Air supply box	K007101		196,00



Aluflex hose	Art. No.	No.	Price
Aluflex hose	N003054		48,00



Iron Dog 04

	Art. No.	No.	Price
Iron Dog 04	50030		3399,00

Energy efficiency index A +



Air supply box	Art. No.	No.	Price
Air supply box	K009160		234,00



Aluflex hose	Art. No.	No.	Price
Aluflex hose	N003054		48,00



Iron Dog 06 with grill function

	Art. No.	No.	Price
Iron Dog 06	K011001		6416,50

Energy efficiency index A +

Accessories	Art. No.	No.	Price
Baking tray	K011152		124,50
Cooking grill (1 piece included in delivery of Iron Dog 06)	K011037		193,50
Double-enamelled cast iron oven-pan	K011151		135,00



Air supply box	Art. No.	No.	Price
Air supply box	K011155		196,00



Aluflex hose	Art	No.	Price
Aluflex hose	N003054		48,00



Iron Dog 07

	Art. No.	No.	Price
Iron Dog 07 firing door right	K012001-03		3760,50
Iron Dog 07 firing door left	K012001-04		3760,50

Energy efficiency index A +



Aluflex hose	Art. No.	No.	Price
Aluflex hose	N003054		48,00



Baking oven Kirschgarten

Article description	Art. No.	Price
Baking oven door Kirschgarten	10702	870,50
Baking oven smoke pipe connection ø 180 mm	10280	372,00
Soot cleaning door 1½ tile with cast iron fittings and wooden knob	10617	242,00
Dial thermometer	900118	60,50



Dial thermometer

Mounting accessories

Soot cleaning door Art. No.: 10617

	Frame external dimensions W x H in mm	Frame external dimensions W x H in mm	Dimensions of door opening W x H in mm
1 1/2-tile size	340 x 150 mm	295 x 115 mm	275 x 100 mm



Soot cleaning door

Baking oven Sailerhof



Article description	Art. No.	Price
Baking oven door Sailerhof	10701	468,00
Baking oven smoke pipe connection ø 180 mm	10703	338,50
Soot cleaning door 1½ tile with cast iron fittings and wooden knob	10617	242,00
Dial thermometer	900118	60,50



Baking oven smoke pipe connection



Soot cleaning door



Dial thermometer

Baking oven Feuer-Iglu



Feuer-Iglu



Cast iron doors with 2 wings



Dial thermometer



Damper \varnothing 180 mm
with recessed handle



Fire Igloo working set, 3 pcs.

Article description	Art. No.	Price
Fire Igloo 950 with insulated lid	Q010048	2170,50
Cast iron door 2 wings, with connection block	Q010047	564,50
Dial thermometer 50 - 500 °C	900118	60,50
Damper \varnothing 180 mm with recessed handle	900121	343,00
Fire Igloo working set, 3 pcs. - including: Wooden pizza shovel 105cm /shovel 40 x 30cm Alumin. pizza shovel 130cm /shovel 35 x 30,5cm Cleaning brush with scrapper + wooden handle	900120	182,00



Baking oven Grannus



Grannus top cover for outdoor use



Fire Igloo working set, 3 pcs.



Side table for Grannus with support bearing

Baking oven Grannus

Article description	Art. No.	Price
Baking oven Grannus	Q010079	4074,50
Consisting of: - Grannus thermal concrete cladding - Fire Igloo - lean door - 2 x dial thermometer		
Grannus top cover for outdoor use	Q010072	1033,50
Fire Igloo working set, 3 pcs. - including: Wooden pizza shovel 105cm /shovel 40 x 30cm Alumin. pizza shovel 130cm /shovel 35 x 30,5cm Cleaning brush with scrapper + wooden handle	900120	182,00
Support bearing Grannus (set consisting of 2 pieces galvanized)	Q010102	532,00
Side table for Grannus (without cover plate)	Q010110	1245,50
Support bearing side board	Q010104	223,50



Fireplace grill 24/30

Available variants

Variant	Art. No.	No.	Price
Fireplace grill 24/30, for smaller fireplaces and HKD 2.2	N006092		189,00



Fireplace grill 42/30

Available variants

Variant	Art. No.	No.	Price
Fireplace grill 42/30, for bigger fireplaces	N006090		234,00

MAS

HKD



MAS Modular Accumulators - MAS 360 vertical

Set consists of:	Art. No.	No.	Price
MAS 360 Accumulation stone		6	
Top cover, vertical MAS 360		1	

Additional options			
Reduction for missing cast iron dome when MAS is being used (in case of devices listed below)	D003362		-60,50
MAS 360 storage stone with bore for thermocouple (1 piece necessary for EAS/EOS devices)	10047		158,00
Cleaning brush MAS 110 mm	902248		38,50

Available variants:

MAS 360 suitable for:			
HKD 2.2 flat short HKD 2.2 round short HKD 2.6 short	SET211441		1106,00

flat

MAS Modular Accumulators - MAS 360 horizontal



Set consists of:	Art. No.	No.	Price
MAS 360 Accumulation stone		5	
Top cover, horizontal MAS 360		1	

Additional options			
Reduction for missing cast iron dome when MAS is being used (in case of devices listed below)	D003362		-60,50
MAS 360 storage stone with bore for thermocouple (1 piece necessary for EAS/EOS devices)	10047		158,00
Cleaning brush MAS 110 mm	902248		38,50

Available variants:

MAS 360 suitable for:			
HKD 2.2 flat short HKD 2.2 round short HKD 2.6 short	SET211442		1105,00

Eck

Tunnel



MAS modular top-mount storage SET 440

Set consists of:	Art. No.	No.	Price
MAS 440 Accumulation stone double-layered		5	
Cast iron cover MAS ø 180		1	
Mounting ring		1	

Additional options			
Exchange connecting piece ø 200 mm	R009105		58,00
Exchange connecting piece ø 160 mm	07137		58,00
Cleaning brush MAS 110 mm	902248		38,50

Available variants:

MAS 440 suitable for:			
HKD 2.2 flat HKD 2.2 round HKD 5.1 BKH 5.0 Flach/Tunnel 42-50 BKH 5.0 Flach/Tunnel 42-66 BKH 5.0 Flach/Tunnel 50-98 Stil-Kamin 62/76 Stil-Kamin 75/90 Stil-Kamin 53/88 Eck-Kamin 42/42/42 Eck-Kamin D/S 51/52/52 Eck-Kamin D/S 57/52/52 Eck-Kamin S 57/67/44 Eck-Kamin S 45/67/44 Eck-Kamin S 57//82/48 Eck-Kamin S 45/82/48	SET211444		1670,50



MAS modular top-mount storage SET 440

Set consists of:	Art. No.	No.	Price
MAS 440 Accumulation stone double-layered		5	
Cast iron cover MAS ø 180		1	
Mounting ring		1	

Additional options			
Reduction for missing cast iron dome when MAS is being used (in case of devices listed below)	08287		-60,50
Exchange connecting piece ø 200 mm	R009105		58,00
Exchange connecting piece ø 160 mm	07137		58,00
Cleaning brush MAS 110 mm	902248		38,50

Available variants:

MAS 440 suitable for:			
HKD 6.1 HKD 2.2 round short DF 33	SET211446		1666,00



MAS modular top-mount storage SET 440

Set consists of:	Art. No.	No.	Price
MAS 440 Accumulation stone double-layered		7	
Cast iron cover MAS ø 180		1	
Mounting ring		1	

Additional options

	Art. No.	No.	Price
Exchange connecting piece ø 200 mm	R009105		58,00
Exchange connecting piece ø 160 mm	07137		58,00
Cleaning brush MAS 110 mm	902248		38,50

Available variants:

MAS 440 suitable for:			
HKD 7, HKD 8, HKD 11	SET212772		2100,50



MAS modular top-mount storage SET 440

Set consists of:	Art. No.	No.	Price
MAS 440 Accumulation stone double-layered		3	
Cast iron dome MAS ø 200		1	
Mounting ring		1	

Additional options

	Art. No.	No.	Price
Cleaning brush MAS 110 mm	902248		38,50

Available variants:

MAS 440 suitable for:			
Panorama-Kamin 51/50/50/50	SET213097		1236,00

MSS

Art. No.	Identification of parts	Designation	Price
MSS double-layered			
R013066	1	MSS heat storage module with lining 10 cm, double-layered	107,50
R013065	2	MSS heat storage module with lining 20 cm, double-layered	154,50
R013063	3	MSS T-piece with lining, double-layered	233,50
R013061	4	MSS elbow 90° with lining, double-layered	185,50
R013126	5	MSS inlet block ø 180, double-layered	149,50
R013020	6	MSS steel tape ring, packaging steel tape 16 x 0,5	4,50
R013020-25	6	MSS steel tape ring set 25 pcs. in box	98,50
R013169	7	MSS 3-way elbow 90° ø180, double-layer	315,00
900133		MSS glue Thermofix 1000 1 kg	11,00
900133K		MSS glue in box with 16 pcs. / 1 kg each	180,50

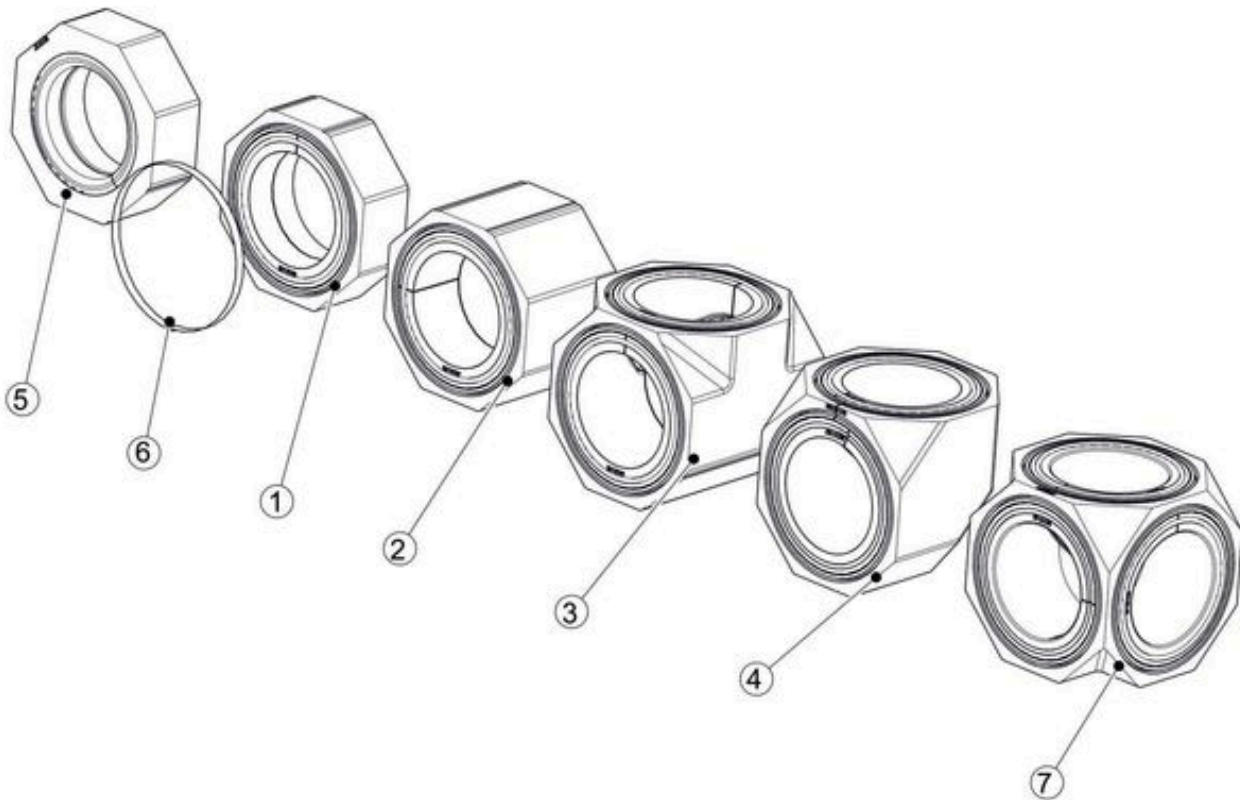

Art. No.	Identification of parts	Designation	Price
MSS single-layered			
R013002	1	MSS heat storage module 10 cm	46,50
R013001	2	MSS heat storage module 20 cm	82,50
R013004	3	MSS T-piece 90°	108,00
R013165	22	MSS elbow 45° single-layer	116,50
R013005	4	MSS elbow 90°	116,50
R013017	5	MSS elbow 90° with cleanout right	149,50
R013018	6	MSS elbow 90° with cleanout left	149,50
R013019	7	MSS elbow 90° with cleanout top	149,50
R013068	8	MSS outlet block ø 160 with sealing	44,50
R013067	9	MSS outlet block ø 180 with sealing	44,50
R013109	11	MSS heat storage module 10 cm with damper flap	292,50
R013016	13	MSS heat storage module 20 cm with cleanout	105,00
R013079	18	MSS cleanout cover with sealing	29,00
R013020	19	MSS steel tape ring, packaging steel tape 16 x 0,5	4,50
R013020-25	19	MSS steel tape ring set 25 pcs. in box	98,50
900133		MSS glue Thermofix 1000 1 kg	11,00
900133K		MSS glue in box with 16 pcs. / 1 kg each	180,50

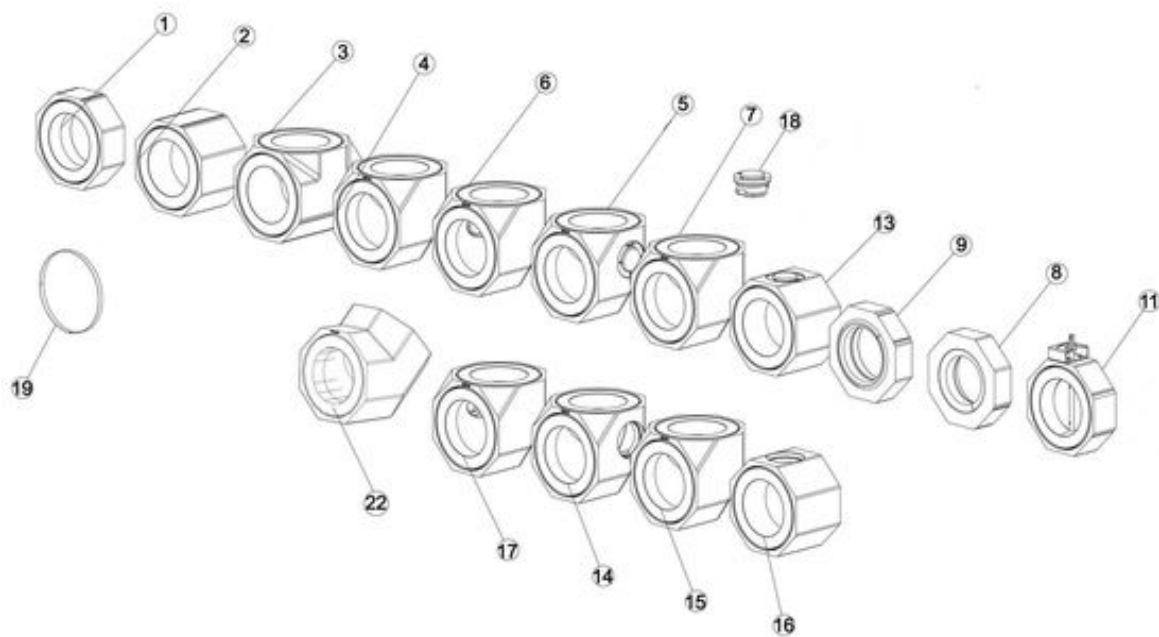

MSS Bypass

If you need to create a bypass, you can set together two MSS with cleanouts, but without using a cleanout cover. In the cleaning openings a bypass has to be inserted. (see MSS assembly instructions)

Art. No.	Identification of parts	Designation	Price
MSS double-layered			
R013073	10	MSS bypass 30 with sealings	34,00
R013074	12	MSS bypass 40 with sealings	34,00
R013009	17	MSS elbow 90° with opening left	121,00
R013006	14	MSS elbow 90° with opening right	121,00
R013007	15	MSS elbow 90° with opening top	121,00
R013003	16	MSS heat storage module 20 cm with opening	97,00

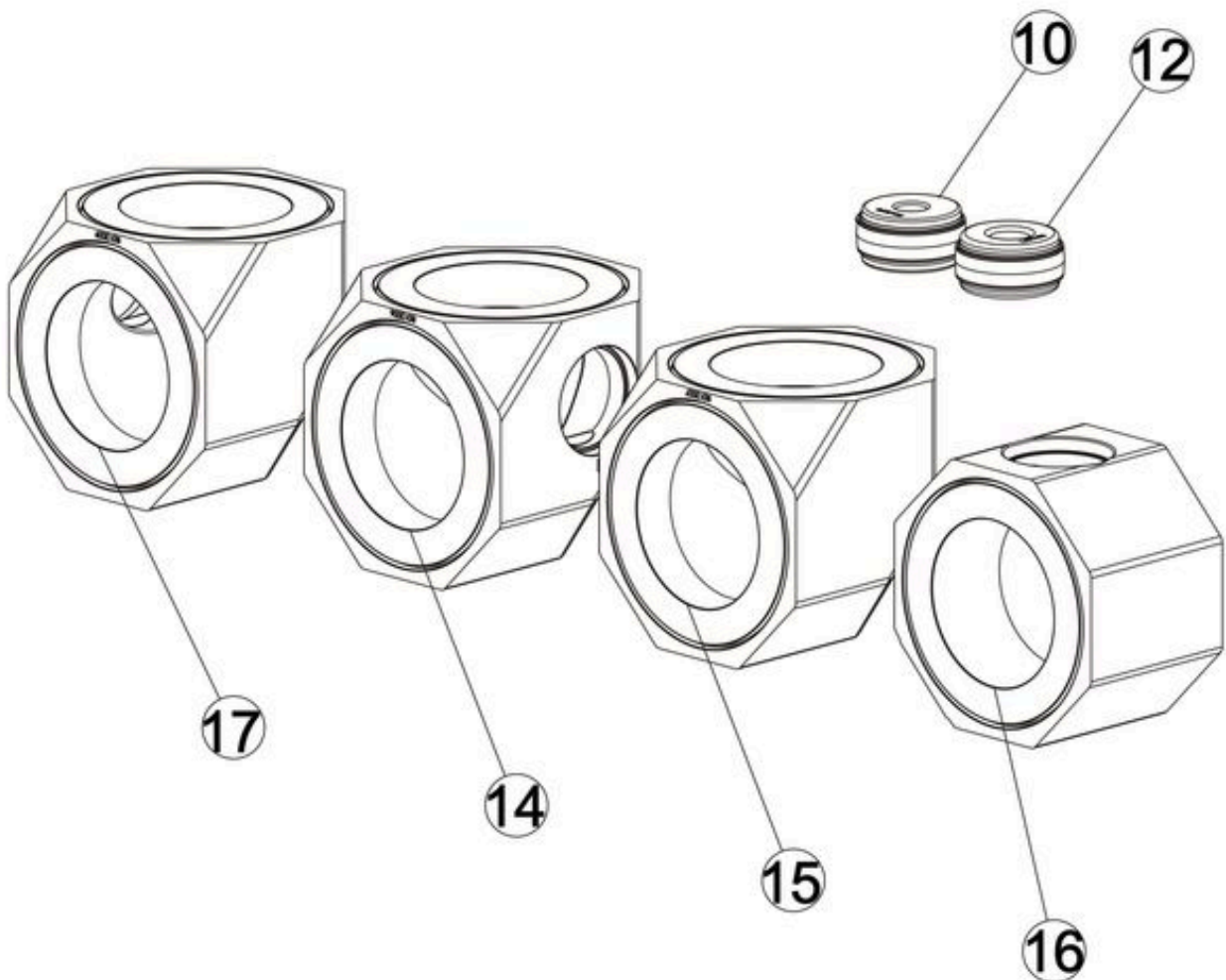

MSS

HKD

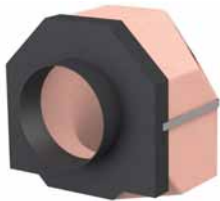
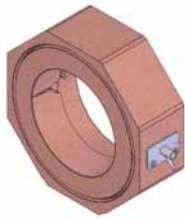

flat

MSS with connection for thermocouple and negative pressure hose

	Art. No.	Price
MSS heat storage module 10 cm with connecting plate for T1, T3 USA (for temperature and negative pressure)	R013133	143,50
MSS inlet adapter for MSS elbow 90 °	R013138	241,00
MSS outlet adapter for MSS Bogen 90 °	R013145	167,50

Art. No.

Identification of parts

Designation

Price

MSS double-layered			
Art. No.	Identification of parts	Designation	Price
R013108	1	MSSI insulating block 30 x 30 cm	35,50
R013107	2	MSSI insulating block 20 x 30 cm	29,00
R013123	3	MSS base plate 75 30 x 30 cm	35,50
R013124	4	MSS base plate 100 30 x 30 cm	37,50

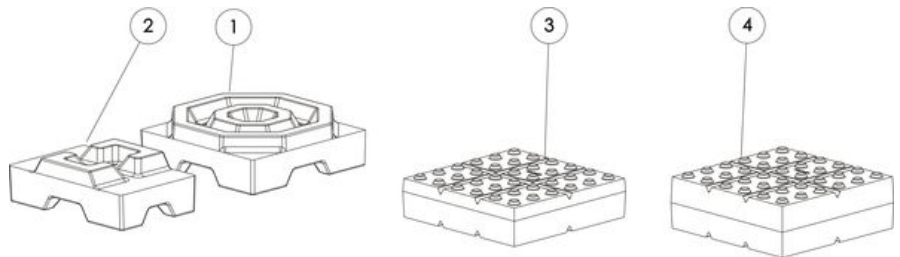

Accessories



	Art. No.	Price
MSS handle with rotating part	R013170	46,50

Eck

Tunnel

MSS Pallets

Art. No.	Pcs./Pallet	Designation	Price
R013018P	16	MSS elbow 90° with cleanout left	2150,00
R013019P	16	MSS elbow 90° with cleanout top	2150,00
R013017P	16	MSS elbow 90° with cleanout right	2150,00
R013005P	16	MSS elbow 90°	1680,50
R013165P	12	MSS elbow 45°	1302,00
R013001P	16	MSS heat storage module 20 cm	1185,00
R013002P	32	MSS heat storage module 10 cm	1340,50
R013061P	16	MSS elbow 90° with lining, double-layered	2673,50
R013004P	16	MSS T-piece 90°	1569,00
R013063P	16	MSS T-piece with lining, double-layered	3362,00
R013067P	16	MSS outlet block ø 180 with sealing	635,50
R013066P	32	MSS heat storage module with lining 10 cm, double-layered	3118,50
R013065P	32	MSS heat storage module with lining 20 cm, double-layered	4461,50
R013126P	40	MSS inlet block ø 180, double-layered	5375,50
R013108P	32	MSSI insulating block 30 x 30 cm	1010,00
R013107P	48	MSSI insulating block 20 x 30 cm	1254,00
R013123P	40	MSS base plate 75, 30 x 30 cm	1262,00
R013124P	32	MSS base plate 100, 30 x 30 cm	1182,00

HKD

Flat

Eck

Tunnel

MAS, MSS, GNF

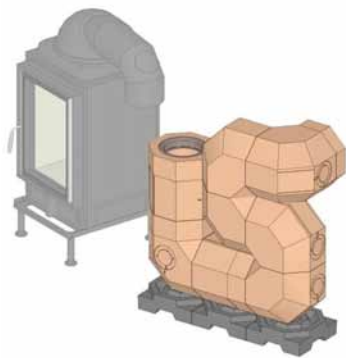

SET213010

MSS heat storage set standing next for HKD stoves 296 kg

Set consists of:	Art. No.	No.	Price
MSS accumulation stone 10 cm	R013002	2	
MSS accumulation stone 20 cm	R013001	2	
MSS elbow 90° with cleanout left	R013018	1	
MSSI insulating block 30x30 cm	R013108	3	
MSS elbow 90°	R013005	1	
MSS elbow 90° with cleanout top	R013019	3	
MSS elbow 90° with opening top	R013007	1	
MSS inlet block ø 180, double-layered	R013126	1	
MSS outlet block ø 160 with sealing	R013068	1	
MSS heat storage module 20 cm with opening	R013003	1	
MSS steel tape ring	R013020	12	
MSS bypass 30 with sealings	R013073	1	
MSS glue Thermofix 1000 1 kg	900133	2	
MSS handle with rotating part	R013170	1	

Available variants:

MSS heat storage set standing next suitable for:			
HKD 7, 8 HKD 11 HKD 4.1, 5.1, 6.1 HKD 2.2, HKD 2.2 XL	SET213010		1647,50

Additional options			
SET socket stones	SET213014		219,00

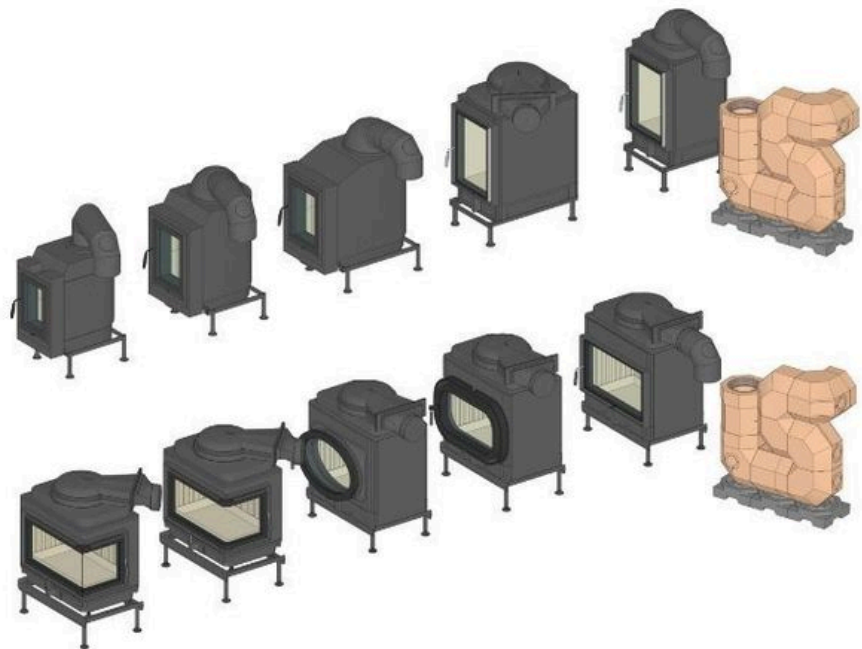

MSS heat storage set standing next for HKD stoves 426 kg

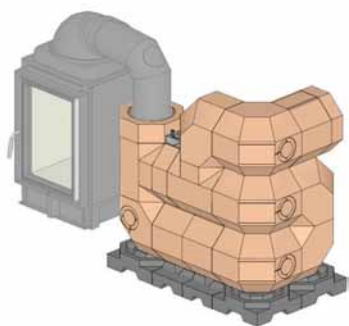

SET213011

Set consists of:	Art. No.	No.	Price
MSS inlet block ø 180, double-layered	R013126	1	
MSS heat storage module 10 cm with damper flap	R013109	1	
MSS outlet block ø 160 with sealing	R013068	1	
MSS T-piece 90°	R013004	2	
MSS elbow 90°	R013005	4	
MSS elbow 90° with cleanout top	R013019	3	
MSS heat storage module 10 cm	R013002	1	
MSS heat storage module 20 cm	R013001	3	
MSS elbow 90° with cleanout left	R013018	1	
MSS steel tape ring	R013020	17	
MSS glue Thermofix 1000 1 kg	900133	3	
MSSI insulating block 30x30 cm	R013108	3	
MSSI insulating block 20x30 cm	R013107	2	
MSS handle with rotating part	R013170	1	
Stainless steel handle for damper flaps / flue gas flaps	10275	1	

Available variants:

MSS heat storage set standing next suitable for:	Art. No.	No.	Price
HKD 7, 8 HKD 11 HKD 4.1, 5.1, 6.1 HKD 2.2, HKD 2.2 XL	SET213011		2526,00

Additional options	Art. No.	No.	Price
SET socket stones	SET213015		187,50

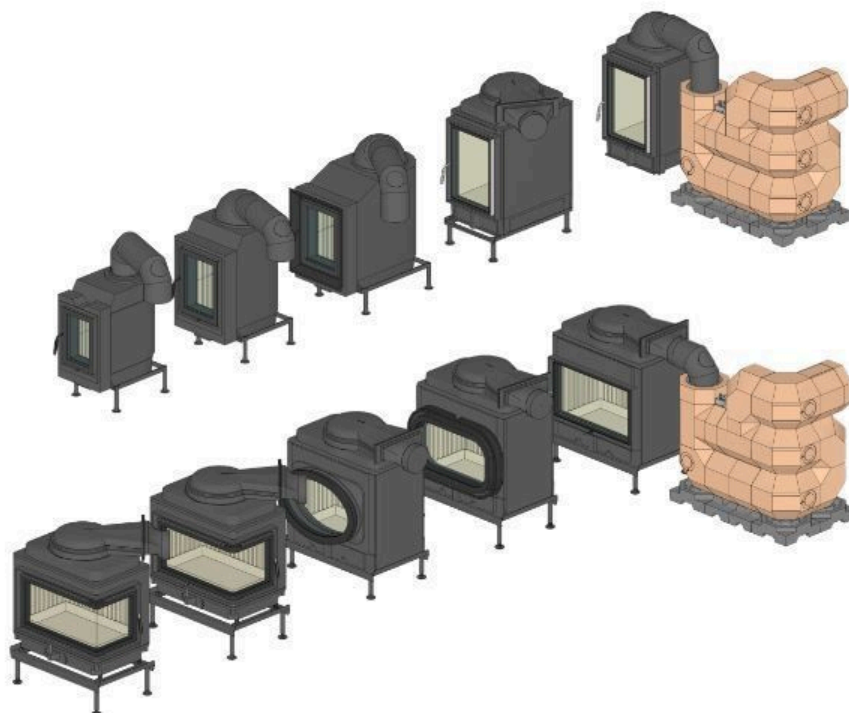

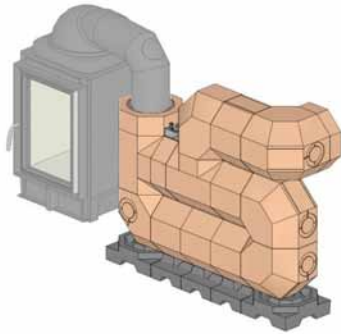

SET213012

MSS heat storage set standing next for HKD stoves 395 kg

Set consists of:	Art. No.	No.	Price
MSS inlet block ø 180, double-layered	R013126	1	
MSS accumulation stone 10 cm	R013109	1	
MSS outlet block ø 160 with sealing	R013068	1	
MSS T-piece 90°	R013004	2	
MSS heat storage module 20 cm	R013001	6	
MSS elbow 90° with cleanout top	R013019	3	
MSS heat storage module 10 cm	R013002	1	
MSS elbow 90°	R013005	1	
MSS elbow 90° with cleanout left	R013018	1	
MSS handle with rotating part	R013170	1	
MSS steel tape ring	R013020	17	
MSS glue Thermofix 1000 1 kg	900133	3	
MSSI insulating block 30x30 cm	R013108	2	
MSSI insulating block 20x30 cm	R013107	3	
Stainless steel handle for damper flaps / flue gas flaps	10275	1	

Available variants:

MSS heat storage set standing next suitable for:	Art. No.	No.	Price
HKD 7, 8 HKD 11 HKD 4.1, 5.1, 6.1 HKD 2.2, HKD 2.2 XL	SET213012		2417,50



MSS heat storage set standing next for HKD stoves 211,5 kg

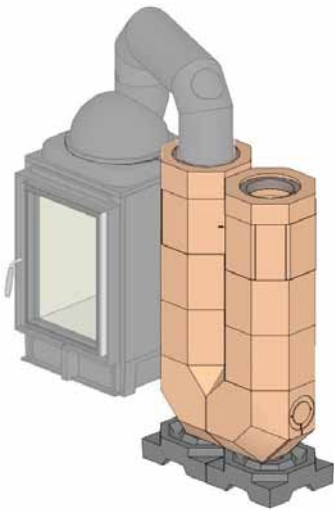

SET213013

Set consists of:	Art. No.	No.	Price
MSS inlet block ø 180, double-layered	R013126	1	
MSS outlet block ø 160 with sealing	R013068	1	
MSS elbow 90°	R013005	1	
MSS heat storage module 20 cm	R013001	4	
MSS elbow 90° with cleanout top	R013019	1	
MSS heat storage module 20 cm with opening	R013003	2	
MSS bypass 30 with sealings	R013073	1	
MSS steel tape ring	R013020	9	
MSS glue Thermofix 1000 1 kg	900133	2	
MSSI insulating block 30x30 cm	R013108	2	
MSS handle with rotating part	R013170	1	

Available variants:

MSS heat storage set standing next suitable for:	SET213013	1198,00
HKD 6.1 HKD 7, 8 HKD 11 HKD 4.1, 5.1 HKD 2.2		

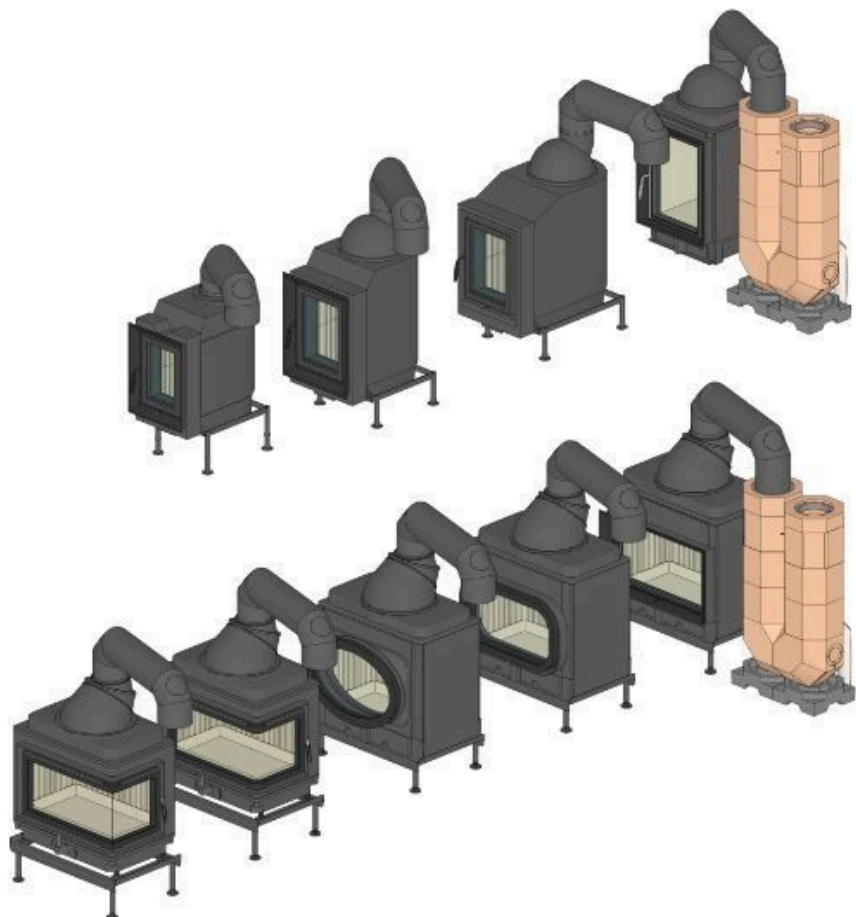

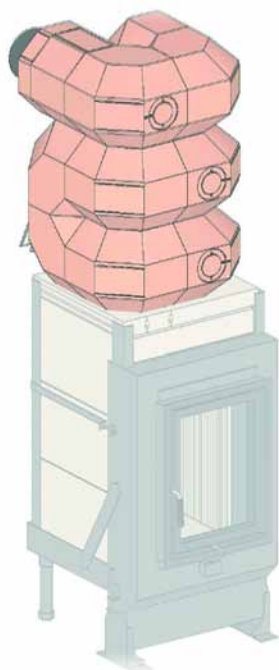

MSS heat storage set standing on top 400 kg

Set consists of:	Art. No.	No.	Price
Accumulation stone MSS connecting block / GOF top cover	G013196	1	
MSS elbow 90° with lining, double-layered	R013061	1	
MSS elbow 90° with cleanout top	R013019	3	
MSS outlet block ø 180 with sealing	R013067	1	
MSS heat storage module 20 cm	R013001	1	
MSS elbow 90°	R013005	6	
MSS steel tape ring, packaging steel tape 16 x 0,5	R013020	13	
MSS glue Thermofix 1000 1 kg	900133	2	
MSS elbow 90° with cleanout left	R013018	1	
MSS handle with rotating part	R013170	1	

Available variants:

MSS heat storage set standing on top suitable for:			
GOF 37x42 + GOT 52/37-ZL side-opening door	SET211451		1894,50

With the MSS set a flue outlet can be realized either to the left or right side.

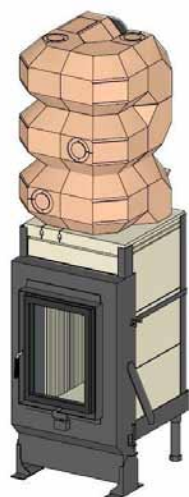

MSS heat storage set standing on top 300 kg

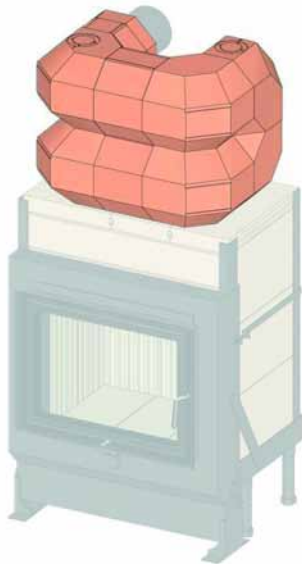

Set consists of:	Art. No.	No.	Price
Accumulation stone MSS connecting block / GOF top cover	G013196	1	
MSS elbow 90° with lining, double-layered	R013061	1	
MSS elbow 90° with cleanout top	R013019	1	
MSS outlet block ø 180 with sealing	R013067	1	
MSS heat storage module 10 cm	R013002	1	
MSS elbow 90°	R013005	4	
MSS elbow 90° with cleanout left	R013018	1	
MSS steel tape ring, packaging steel tape 16 x 0,5	R013020	11	
MSS glue Thermofix 1000 1 kg	900133	2	
MSS heat storage module 20 cm	R013001	2	
MSS handle with rotating part	R013170	1	

Available variants:

MSS heat storage set standing on top suitable for:			
GOF 66x42 + GOT 51/67-ZL side-opening door	SET211412		1482,50

With the MSS set a flue outlet can be realized either to the left or right side.

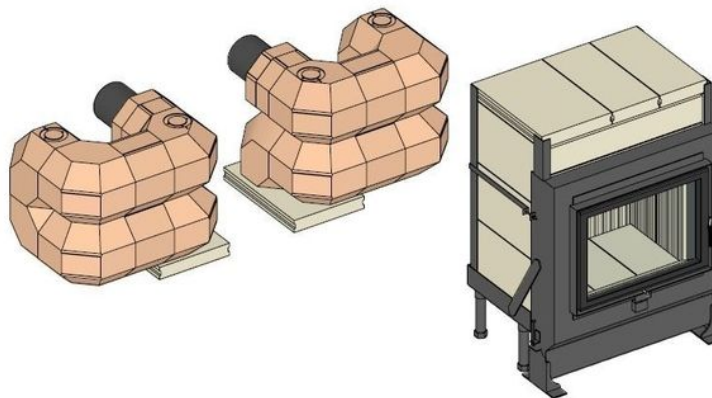



MSS heat storage set standing on top 270 kg

Set consists of:	Art. No.	No.	Price
Accumulation stone MSS connecting block / GOF top cover	G013196	1	
MSS elbow 90° with lining, double-layered	R013061	1	
MSS elbow 90° with cleanout top	R013019	2	
MSS outlet block ø 180 with sealing	R013067	1	
MSS heat storage module 20 cm	R013001	1	
MSS elbow 90°	R013005	3	
MSS steel tape ring, packaging steel tape 16 x 0,5	R013020	9	
MSS glue Thermofix 1000 1 kg	900133	1	
MSS elbow 90° with cleanout right	R013017	1	
MSS handle with rotating part	R013170	1	

Available variants:

MSS heat storage set standing on top suitable for:			
GOF 37x37 + GOT HKD 6.1	SET211453		1366,50
GOF 37x37 + GOT HKD 5.1/12			

With the MSS set a flue outlet can be realized either to the left or right side.

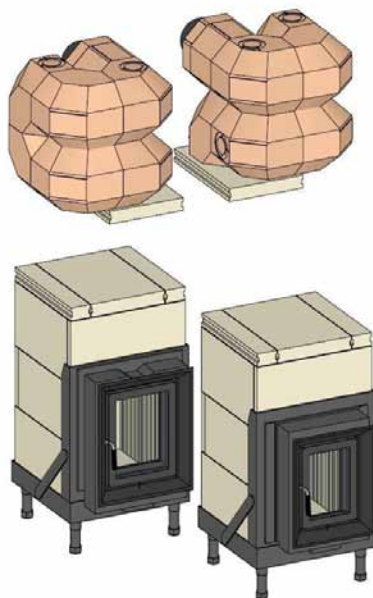

MSS heat storage set standing next 410 kg

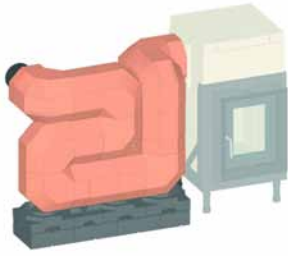

Set consists of:	Art. No.	No.	Price
Accumulation stone MSS connecting block / GOF side	G015107	1	
MSS elbow 90° with lining, double-layered	R013061	1	
MSS outlet block ø 180 with sealing	R013067	1	
MSS heat storage module 10 cm	R013002	2	
MSS elbow 90°	R013005	3	
MSS steel tape ring, packaging steel tape 16 x 0,5	R013020	18	
MSS glue Thermofix 1000 1 kg	900133	2	
MSS heat storage module 20 cm	R013001	5	
MSSI insulating block 30x30 cm	R013108	3	
MSSI insulating block 20x30 cm	R013107	1	
MSS elbow 90° with opening left	R013009	1	
MSS elbow 90° with opening top	R013007	1	
MSS bypass 30 with sealings	R013073	1	
MSS heat storage module with lining 10 cm, double-layered	R013066	1	
MSS base plate 100 30x30 cm	R013124	4	
MSS elbow 90° with cleanout top	R013019	2	
MSS handle with rotating part	R013170	1	

Available variants:

MSS heat storage set standing on top suitable for:			
GOF 37x37 + GOT HKD 6.1	SET211457		2326,50
GOF 37x37 + GOT HKD 5.1/12			

The MSS accumulation block can be mounted either to the left or right side of the GOF

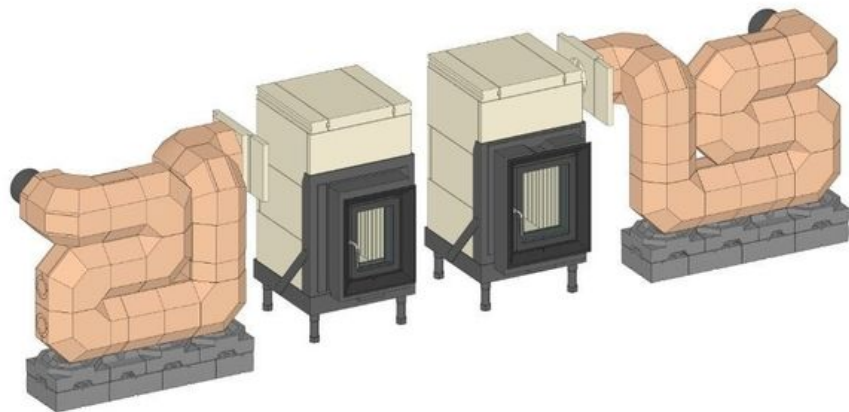

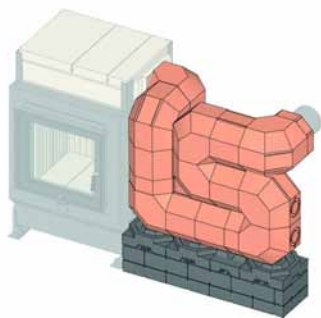

MSS heat storage set standing next 410 kg

Set consists of:	Art. No.	No.	Price
Accumulation stone MSS connecting block / GOF side	G015107	1	
MSS elbow 90° with lining, double-layered	R013061	1	
MSS elbow 90° with cleanout top	R013019	2	
MSS outlet block ø 180 with sealing	R013067	1	
MSS heat storage module 10 cm	R013002	2	
MSS elbow 90°	R013005	3	
MSS steel tape ring, packaging steel tape 16 x 0,5	R013020	18	
MSS glue Thermofix 1000 1 kg	900133	3	
MSS heat storage module 20 cm	R013001	5	
MSSI insulating block 30x30 cm	R013108	3	
MSSI insulating block 20x30 cm	R013107	1	
MSS elbow 90° with opening left	R013009	1	
MSS elbow 90° with opening top	R013007	1	
MSS bypass 30 with sealings	R013073	1	
MSS heat storage module with lining 10 cm, double-layered	R013066	1	
MSS base plate 75 30x30 cm	R013123	4	
MSS base plate 100 30x30 cm	R013124	4	
MSS handle with rotating part	R013170	1	

Available variants:

MSS heat storage set standing next suitable for:			
GOF 37x42 + GOT 52/37-ZL side-opening door	SET211417		2479,50
GOF 55x42 + GOT 51/67-ZL side-opening door			

The MSS accumulation block can be mounted either to the left or right side of the GOF

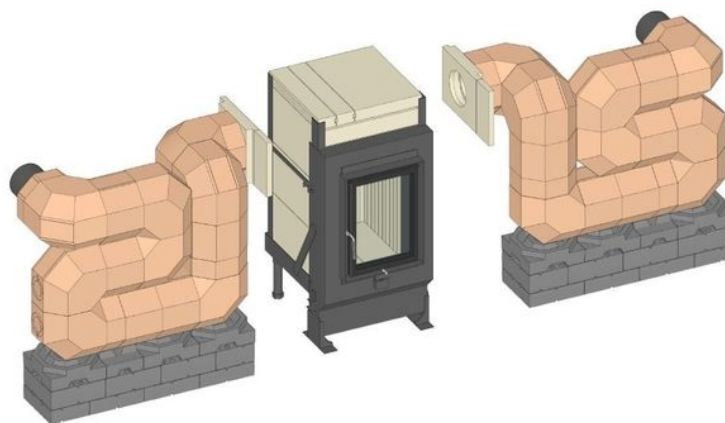

MSS heat storage set standing next (bank) 390 kg

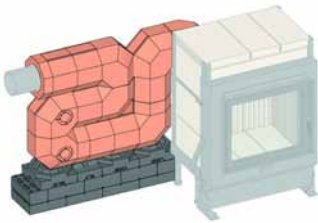

Set consists of:	Art. No.	No.	Price
Accumulation stone MSS connecting block / GOF side	G015107	1	
MSS elbow 90° with lining, double-layered	R013061	1	
MSS outlet block ø 180 with sealing	R013067	1	
MSS heat storage module 10 cm	R013002	2	
MSS elbow 90°	R013005	2	
MSS steel tape ring, packaging steel tape 16 x 0,5	R013020	17	
MSS glue Thermofix 1000 1 kg	900133	3	
MSS heat storage module 20 cm	R013001	6	
MSSI insulating block 30x30 cm	R013108	3	
MSSI insulating block 20x30 cm	R013107	1	
MSS elbow 90° with opening top	R013007	2	
MSS bypass 30 with sealings	R013073	1	
MSS base plate 75 30x30 cm	R013123	4	
MSS base plate 100 30x30 cm	R013124	4	
MSS elbow 90° with cleanout right	R013017	2	
MSS handle with rotating part	R013170	1	

Available variants:

MSS heat storage set standing next suitable for:		
GOF 37x42 + GOT 52/37-ZL side-opening door	SET211418	2333,50
GOF 66x42 + GOT 51/67-ZL side-opening door		

The MSS accumulation block can be mounted either to the left or right side of the GOF

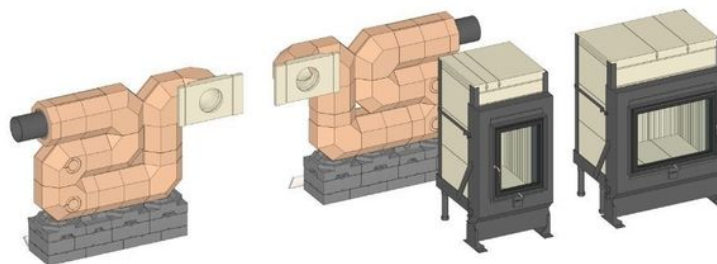

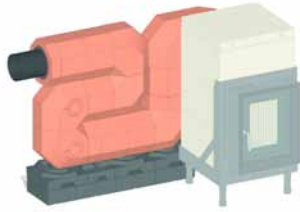

MSS heat storage set standing next (bank) 390 kg

Set consists of:	Art. No.	No.	Price
Accumulation stone MSS connecting block / GOF side	G015107	1	
MSS elbow 90° with lining, double-layered	R013061	1	
MSS outlet block ø 180 with sealing	R013067	1	
MSS heat storage module 10 cm	R013002	2	
MSS elbow 90°	R013005	2	
MSS steel tape ring, packaging steel tape 16 x 0,5	R013020	17	
MSS glue Thermofix 1000 1 kg	900133	3	
MSS heat storage module 20 cm	R013001	6	
MSSI insulating block 30x30 cm	R013108	3	
MSSI insulating block 20x30 cm	R013107	1	
MSS elbow 90° with opening top	R013007	2	
MSS bypass 30 with sealings	R013073	1	
MSS base plate 100 30x30 cm	R013124	4	
MSS elbow 90° with cleanout right	R013017	2	
MSS handle with rotating part	R013170	1	

Available variants:

MSS heat storage set standing next suitable for:			
GOF 37x37+ GOT HKD 5.1/12 GOF 37x37 + GOT HKD 6.1	SET211459		2191,50

The MSS accumulation block can be mounted either to the left or right side of the GOF

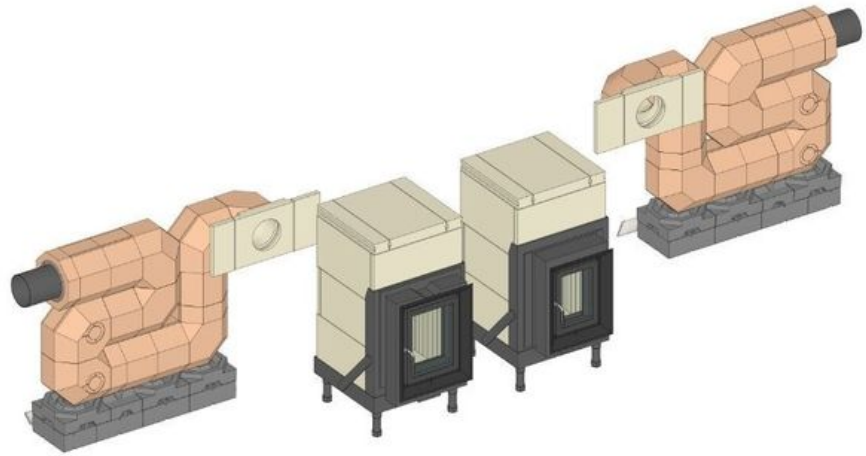

MSS heat storage set standing next 430 kg

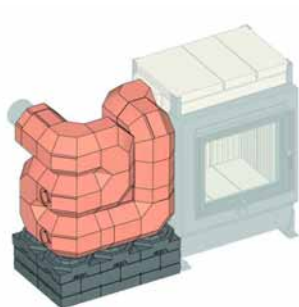

Set consists of:	Art. No.	No.	Price
Accumulation stone MSS connecting block / GOF side	G015107	1	
MSS elbow 90° with lining, double-layered	R013061	1	
MSS elbow 90° with cleanout top	R013019	2	
MSS outlet block ø 180 with sealing	R013067	1	
MSS heat storage module 10 cm	R013002	2	
MSS elbow 90°	R013005	5	
MSS steel tape ring, packaging steel tape 16 x 0,5	R013020	17	
MSS glue Thermofix 1000 1 kg	900133	3	
MSS heat storage module 20 cm	R013001	3	
MSSI insulating block 30x30 cm	R013108	4	
MSS elbow 90° with opening left	R013009	1	
MSS elbow 90° with opening top	R013007	1	
MSS bypass 30 with sealings	R013073	1	
MSS heat storage module with lining 10 cm, double-layered	R013066	1	
MSS base plate 75 30x30 cm	R013123	4	
MSS base plate 100 30x30 cm	R013124	4	
MSS handle with rotating part	R013170	1	

Available variants:

MSS heat storage set standing next suitable for:			
GOF 37x42 + GOT 52/37-ZL side-opening door	SET211420		2549,50
GOF 66x42 + GOT 51/67-ZL side-opening door			

The MSS accumulation block can be mounted either to the left or right side of the GOF

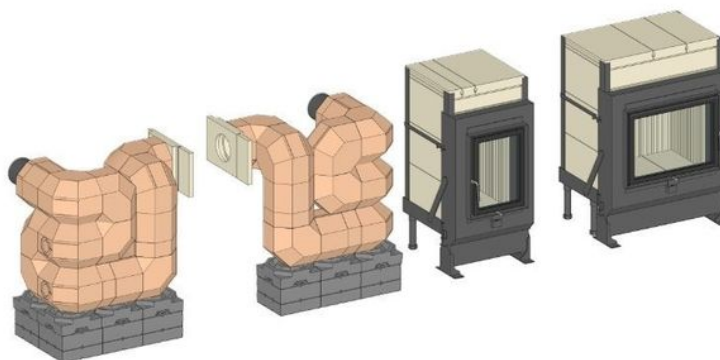

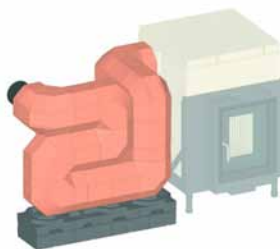

MSS heat storage set standing next 430 kg

Set consists of:	Art. No.	No.	Price
Accumulation stone MSS connecting block / GOF side	G015107	1	
MSS elbow 90° with lining, double-layered	R013061	1	
MSS outlet block ø 180 with sealing	R013067	1	
MSS heat storage module 10 cm	R013002	2	
MSS elbow 90°	R013005	3	
MSS steel tape ring, packaging steel tape 16 x 0,5	R013020	19	
MSS glue Thermofix 1000 1 kg	900133	3	
MSS heat storage module 20 cm	R013001	6	
MSSI insulating block 30x30 cm	R013108	3	
MSSI insulating block 20x30 cm	R013107	1	
MSS elbow 90° with opening left	R013009	1	
MSS elbow 90° with opening top	R013007	1	
MSS bypass 30 with sealings	R013073	1	
MSS heat storage module with lining 10 cm, double-layered	R013066	1	
MSS base plate 100 30x30 cm	R013124	4	
MSS elbow 90° with cleanout top	R013019	2	
MSS handle with rotating part	R013170	1	

Available variants:

MSS heat storage set standing next suitable for:			
GOF 37x37+ GOT HKD 5.1/12	SET211458		2424,50
GOF 37x37 + GOT HKD 6.1			

The MSS accumulation block can be mounted either to the left or right side of the GOF

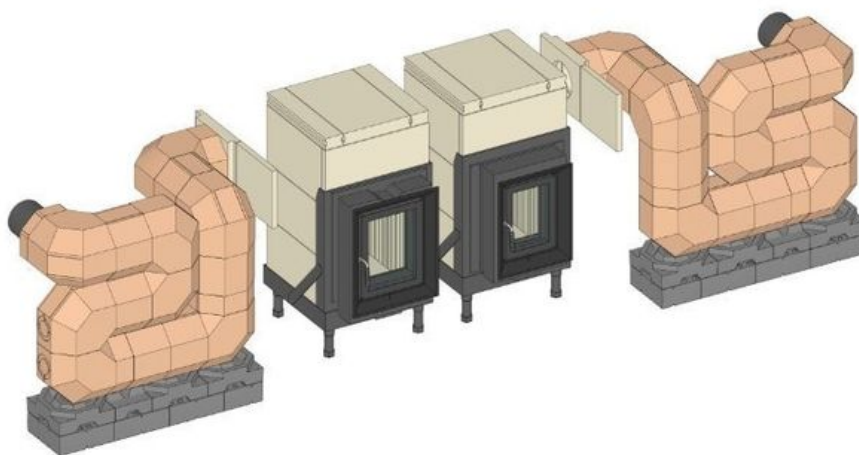

MSS heat storage set standing next 430 kg



Set consists of:	Art. No.	No.	Price
Accumulation stone MSS connecting block / GOF side	G015107	1	
MSS elbow 90° with lining, double-layered	R013061	1	
MSS outlet block ø 180 with sealing	R013067	1	
MSS heat storage module 10 cm	R013002	2	
MSS elbow 90°	R013005	5	
MSS steel tape ring, packaging steel tape 16 x 0,5	R013020	17	
MSS glue Thermofix 1000 1 kg	900133	3	
MSS heat storage module 20 cm	R013001	3	
MSSI insulating block 30x30 cm	R013108	4	
MSS elbow 90° with opening top	R013007	1	
MSS bypass 30 with sealings	R013073	1	
MSS base plate 100 30x30 cm	R013124	4	
MSS heat storage module with lining 10 cm, double-layered	R013066	1	
MSS elbow 90° with cleanout top	R013019	2	
MSS elbow 90° with opening left	R013009	1	
MSS handle with rotating part	R013170	1	

Available variants:

MSS heat storage set standing next suitable for:		
GOF 37x37+ GOT HKD 5.1/12	SET211460	2407,50
GOF 37x37 + GOT HKD 6.1		

The MSS accumulation block can be mounted either to the left or right side of the GOF

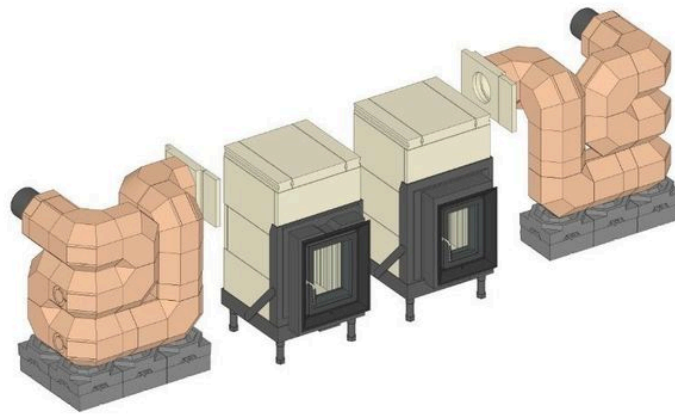

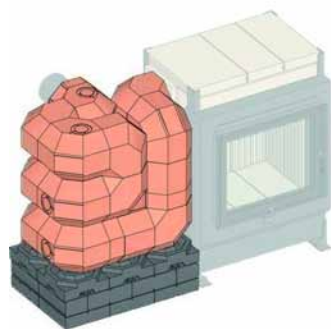

MSS heat storage set standing next 530 kg

Set consists of:	Art. No.	No.	Price
Accumulation stone MSS connecting block / GOF side	G015107	1	
MSS elbow 90° with lining, double-layered	R013061	1	
MSS elbow 90° with cleanout top	R013019	2	
MSS outlet block ø 180 with sealing	R013067	1	
MSS heat storage module 10 cm	R013002	2	
MSS elbow 90°	R013005	7	
MSS steel tape ring, packaging steel tape 16 x 0,5	R013020	21	
MSS glue Thermofix 1000 1 kg	900133	3	
MSS heat storage module 20 cm	R013001	2	
MSSI insulating block 30x30 cm	R013108	6	
MSS elbow 90° with opening left	R013009	1	
MSS elbow 90° with opening top	R013007	1	
MSS bypass 30 with sealings	R013073	1	
MSS heat storage module with lining 10 cm, double-layered	R013066	1	
MSS base plate 75 30x30 cm	R013123	6	
MSS base plate 100 30x30 cm	R013124	6	
MSS elbow 90° with cleanout right	R013017	2	
MSS handle with rotating part	R013170	1	

Available variants:

MSS heat storage set standing next suitable for:			
GOF 37x42 + GOT 52/37-ZL side-opening door	SET211421		3234,00
GOF 66x42 + GOT 51/67-ZL side-opening door			

The MSS accumulation block can be mounted either to the left or right side of the GOF

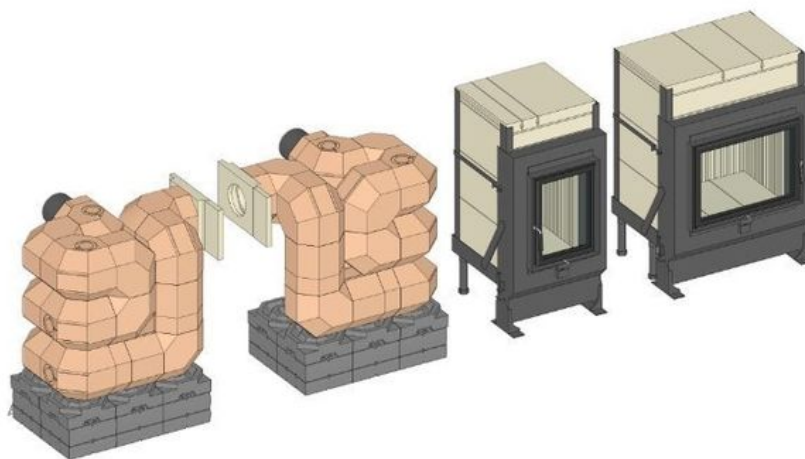

MSS heat storage set standing next 530 kg

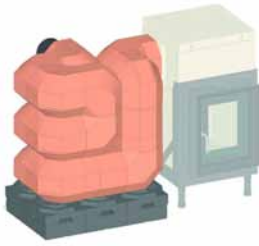

Set consists of:	Art. No.	No.	Price
Accumulation stone MSS connecting block / GOF side	G015107	1	
MSS elbow 90° with lining, double-layered	R013061	1	
MSS outlet block ø 180 with sealing	R013067	1	
MSS heat storage module 10 cm	R013002	2	
MSS elbow 90°	R013005	7	
MSS steel tape ring, packaging steel tape 16 x 0,5	R013020	21	
MSS glue Thermofix 1000 1 kg	900133	3	
MSS heat storage module 20 cm	R013001	2	
MSSI insulating block 30x30 cm	R013108	6	
MSS elbow 90° with opening top	R013007	1	
MSS bypass 30 with sealings	R013073	1	
MSS base plate 100 30x30 cm	R013124	6	
MSS heat storage module with lining 10 cm, double-layered	R013066	1	
MSS elbow 90° with cleanout top	R013019	2	
MSS elbow 90° with opening left	R013009	1	
MSS elbow 90° with cleanout right	R013017	2	
MSS handle with rotating part	R013170	1	

Available variants:

MSS heat storage set standing next suitable for:		
GOF 37x37+ GOT HKD 5.1/12	SET211462	3021,00
GOF 37x37 + GOT HKD 6.1		

The MSS accumulation block can be mounted either to the left or right side of the GOF

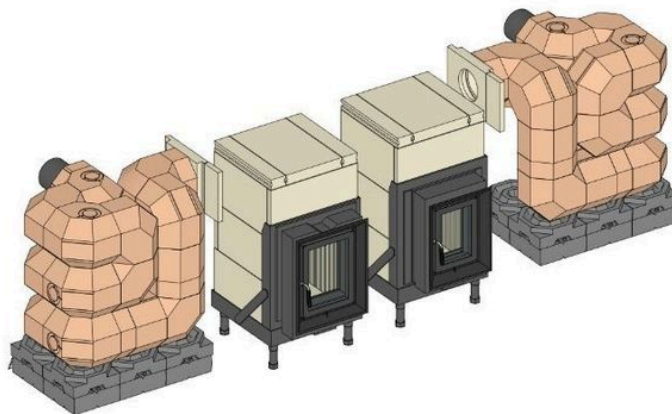

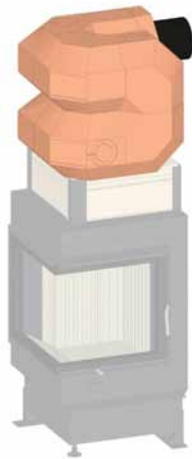

MSS heat storage set standing on top 280 kg

Set consists of:	Art. No.	No.	Price
Accumulation stone MSS connecting block / GOF top cover	G021138	1	
MSS elbow 90° with lining, double-layered	R013061	1	
MSS elbow 90°	R013018	1	
MSS elbow 90°	R013005	3	
MSS outlet block ø 180 with sealing	R013067	1	
MSS steel tape ring, packaging steel tape 16 x 0,5	R013020	9	
MSS glue Thermofix 1000 1 kg	900133	2	
MSS heat storage module 20 cm	R013001	1	
MSS elbow 90°	R013019	2	
MSS handle with rotating part	R013170	1	

Available variants:

MSS heat storage set standing on top suitable for:			
GOF 35x35 + GOT 51/52/52-ZL side-opening door	SET211507		1364,00

Note: For top-mount MSS kits in connection with door frame and flush casing, it is necessary to plan a wall thickness of ≤ 20 mm

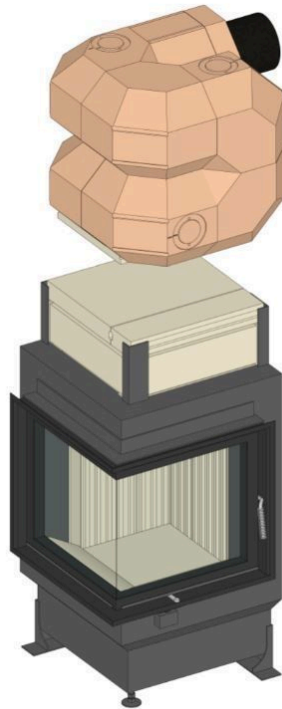

MSS heat storage set standing on top 330 kg



Set consists of:	Art. No.	No.	Price
Accumulation stone MSS connecting block / GOF top cover	G021138	1	
MSS elbow 90° with lining, double-layered	R013061	1	
MSS elbow 90° with cleanout top	R013019	2	
MSS outlet block ø 180 with sealing	R013067	1	
MSS elbow 90°	R013005	3	
MSS steel tape ring, packaging steel tape 16 x 0,5	R013020	14	
MSS glue Thermofix 1000 1 kg	900133	2	
MSS heat storage module 20 cm	R013001	1	
MSS heat storage module with lining 20 cm, double-layered	R013065	1	
MSS heat storage module 10 cm	R013002	4	
MSS elbow 90° with cleanout right	R013017	1	
MSSI insulating block 30x30 cm	R013108	1	
MSSI insulating block 20x30 cm	R013107	2	
MSS base plate 100 30x30 cm	R013124	3	
MSS handle with rotating part	R013170	1	

Available variants:

MSS heat storage set standing on top suitable for:		
GOF 50x35 + GOT 45/67/44-ZL lifting door	SET211455	1933,00

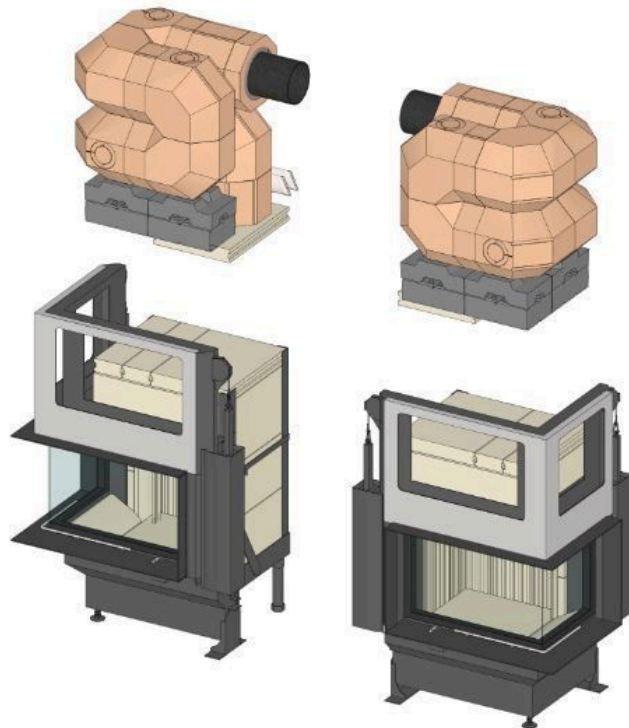

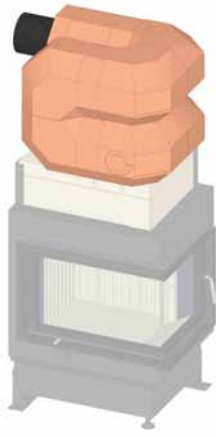

MSS heat storage set standing on top 330 kg

Set consists of:	Art. No.	No.	Price
Accumulation stone MSS connecting block / GOF top cover	G021138	1	
MSS elbow 90° with lining, double-layered	R013061	1	
MSS outlet block ø 180 with sealing	R013067	1	
MSS elbow 90°	R013005	3	
MSS steel tape ring, packaging steel tape 16 x 0,5	R013020	13	
MSS glue Thermofix 1000 1 kg	900133	2	
MSS heat storage module 10 cm	R013002	4	
MSS heat storage module 20 cm	R013001	1	
MSS elbow 90°	R013019	2	
MSS elbow 90°	R013017	1	
MSS handle with rotating part	R013170	1	

Available variants:

MSS heat storage set standing on top suitable for:			
GOF 50x35 + GOT 45/67/44-ZL side-opening door	SET211506		1568,00

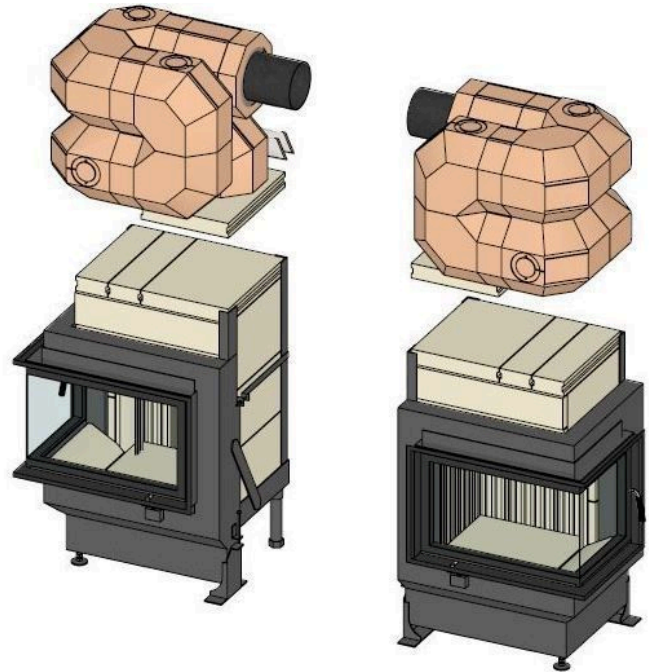

MSS heat storage set standing next at corner right side 390 kg

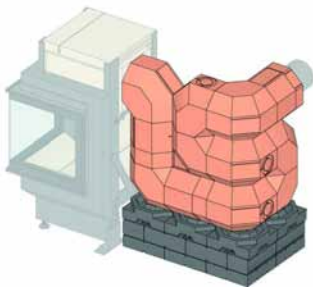

Set consists of:	Art. No.	No.	Price
Accumulation stone MSS connecting block / GOF side	G023205	1	
MSS elbow 90° with lining, double-layered	R013061	1	
MSS elbow 90° with cleanout top	R013019	3	
MSS outlet block ø 180 with sealing	R013067	1	
MSS heat storage module 10 cm	R013002	2	
MSS elbow 90°	R013005	4	
MSS steel tape ring, packaging steel tape 16 x 0,5	R013020	15	
MSS glue Thermofix 1000 1 kg	900133	2	
MSS heat storage module 20 cm	R013001	2	
MSSI insulating block 30x30 cm	R013108	4	
MSS elbow 90° with opening top	R013007	1	
MSS bypass 30 with sealings	R013073	1	
MSS base plate 75 30x30 cm	R013123	4	
MSS base plate 100 30x30 cm	R013124	4	
MSS heat storage module 20 cm with opening	R013003	1	
MSS handle with rotating part	R013170	1	

Available variants:

MSS heat storage set standing next suitable for:		
GOF 35x35 + GOT 51/52/52-ZL side-opening door	SET211423	2348,50

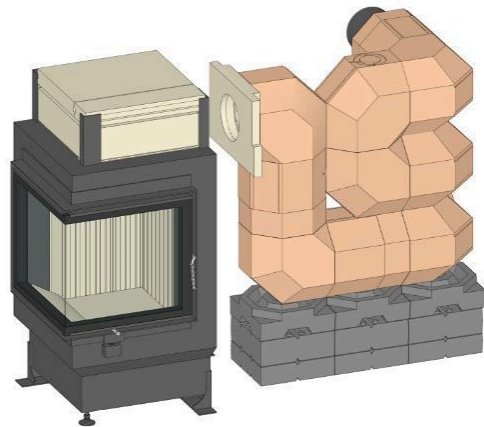

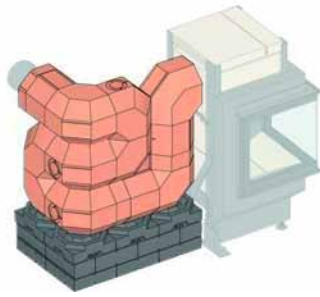

MSS heat storage set standing next at corner left side 390 kg

Set consists of:	Art. No.	No.	Price
Accumulation stone MSS connecting block / GOF side	G023204	1	
MSS elbow 90° with lining, double-layered	R013061	1	
MSS elbow 90° with cleanout top	R013019	3	
MSS outlet block ø 180 with sealing	R013067	1	
MSS heat storage module 10 cm	R013002	2	
MSS elbow 90°	R013005	4	
MSS steel tape ring, packaging steel tape 16 x 0,5	R013020	15	
MSS glue Thermofix 1000 1 kg	900133	2	
MSS heat storage module 20 cm	R013001	2	
MSSI insulating block 30x30 cm	R013108	4	
MSS elbow 90° with opening top	R013007	1	
MSS bypass 30 with sealings	R013073	1	
MSS base plate 75 30x30 cm	R013123	4	
MSS base plate 100 30x30 cm	R013124	4	
MSS heat storage module 20 cm with opening	R013003	1	
MSS handle with rotating part	R013170	1	

Available variants:

MSS heat storage set standing next suitable for:		
GOF 35x35 + GOT 51/52/52-ZL side-opening door	SET211422	2348,50

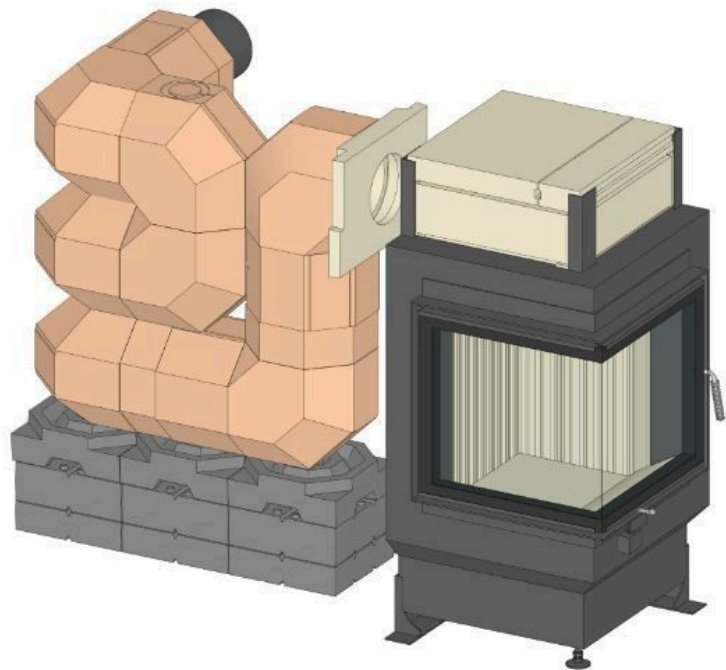

MSS heat storage set standing next at corner right side 390 kg

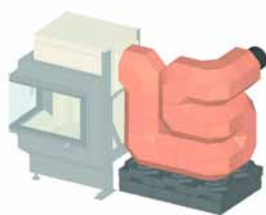

Set consists of:	Art. No.	No.	Price
Accumulation stone MSS connecting block / GOF side	G023205	1	
MSS elbow 90° with lining, double-layered	R013061	1	
MSS elbow 90° with cleanout top	R013019	3	
MSS outlet block ø 180 with sealing	R013067	1	
MSS heat storage module 10 cm	R013002	2	
MSS elbow 90°	R013005	4	
MSS steel tape ring, packaging steel tape 16 x 0,5	R013020	15	
MSS glue Thermofix 1000 1 kg	900133	2	
MSS heat storage module 20 cm	R013001	2	
MSSI insulating block 30x30 cm	R013108	4	
MSS elbow 90° with opening top	R013007	1	
MSS bypass 30 with sealings	R013073	1	
MSS heat storage module 20 cm with opening	R013003	1	
MSS base plate 100 30x30 cm	R013124	4	
MSS handle with rotating part	R013170	1	

Available variants:

MSS heat storage set standing next suitable for:		
GOF 50x35 + GOT 45/67/44-ZL lifting door/side opening door	SET211436	2206,50



MSS heat storage set standing next at corner left side 390 kg

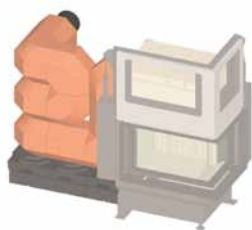

Set consists of:	Art. No.	No.	Price
Accumulation stone MSS connecting block / GOF side	G023204	1	
MSS elbow 90° with lining, double-layered	R013061	1	
MSS elbow 90° with cleanout top	R013019	3	
MSS outlet block ø 180 with sealing	R013067	1	
MSS heat storage module 10 cm	R013002	2	
MSS elbow 90°	R013005	4	
MSS steel tape ring, packaging steel tape 16 x 0,5	R013020	15	
MSS glue Thermofix 1000 1 kg	900133	2	
MSS heat storage module 20 cm	R013001	2	
MSSI insulating block 30x30 cm	R013108	4	
MSS elbow 90° with opening top	R013007	1	
MSS bypass 30 with sealings	R013073	1	
MSS heat storage module 20 cm with opening	R013003	1	
MSS base plate 100 30x30 cm	R013124	4	
MSS handle with rotating part	R013170	1	

Available variants:

MSS heat storage set standing next suitable for:			
GOF 50x35 + GOT 45/67/44-ZL lifting door/side opening door	SET211502		2206,50

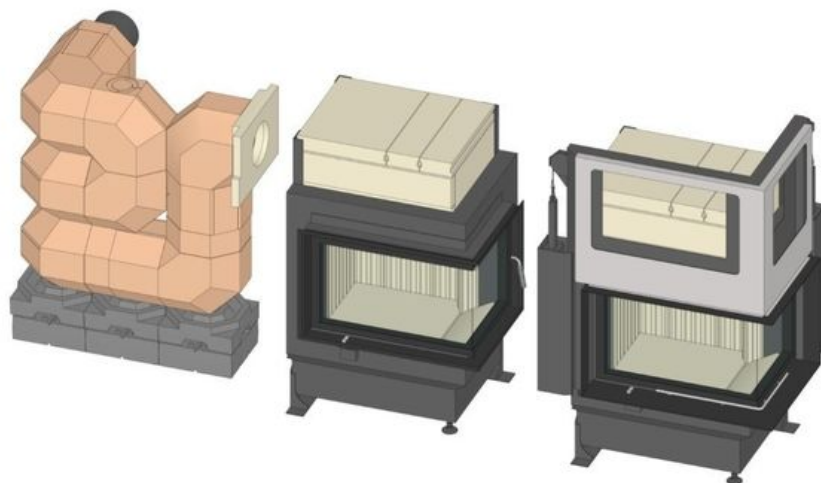

HKD

flat

Eck

Tunnel

MSS heat storage set standing next in the corner right side 410 kg

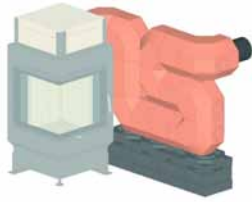

Set consists of:	Art. No.	No.	Price
Accumulation stone MSS connecting block / GOF side	G023205	1	
MSS elbow 90° with lining, double-layered	R013061	1	
MSS elbow 90° with cleanout top	R013019	3	
MSS outlet block ø 180 with sealing	R013067	1	
MSS heat storage module 10 cm	R013002	2	
MSS elbow 90°	R013005	2	
MSS steel tape ring, packaging steel tape 16 x 0,5	R013020	18	
MSS glue Thermofix 1000 1 kg	900133	2	
MSS heat storage module 20 cm	R013001	5	
MSSI insulating block 30x30 cm	R013108	3	
MSS elbow 90° with opening top	R013007	2	
MSS bypass 30 with sealings	R013073	1	
MSS base plate 75 30x30 cm	R013123	4	
MSS base plate 100 30x30 cm	R013124	4	
MSSI insulating block 20x30 cm	R013107	1	
MSS heat storage module with lining 10 cm, double-layered	R013066	1	
MSS handle with rotating part	R013170	1	

Available variants:

MSS heat storage set standing next suitable for:		
GOF 35x35 + GOT 51/52/52-ZL side-opening door	SET211425	2501,50

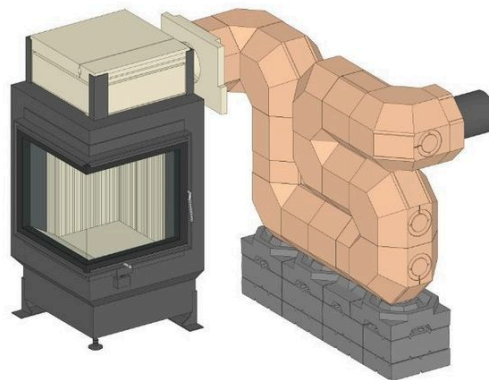

MSS heat storage set standing next in the corner left side 410 kg

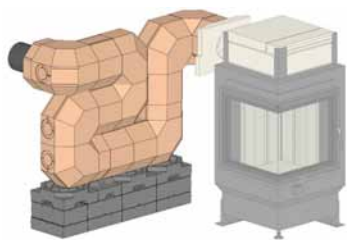

Set consists of:	Art. No.	No.	Price
Accumulation stone MSS connecting block / GOF side	G023204	1	
MSS elbow 90° with lining, double-layered	R013061	1	
MSS elbow 90° with cleanout top	R013019	3	
MSS outlet block ø 180 with sealing	R013067	1	
MSS heat storage module 10 cm	R013002	2	
MSS elbow 90°	R013005	2	
MSS steel tape ring, packaging steel tape 16 x 0,5	R013020	18	
MSS glue Thermofix 1000 1 kg	900133	2	
MSS heat storage module 20 cm	R013001	5	
MSSI insulating block 30x30 cm	R013108	3	
MSS elbow 90° with opening top	R013007	2	
MSS bypass 30 with sealings	R013073	1	
MSS base plate 75 30x30 cm	R013123	4	
MSS base plate 100 30x30 cm	R013124	4	
MSSI insulating block 20x30 cm	R013107	1	
MSS heat storage module with lining 10 cm, double-layered	R013066	1	
MSS handle with rotating part	R013170	1	

Available variants:

MSS heat storage set standing next suitable for:		
GOF 35x35 + GOT 51/52/52-ZL side-opening door	SET211437	2501,50

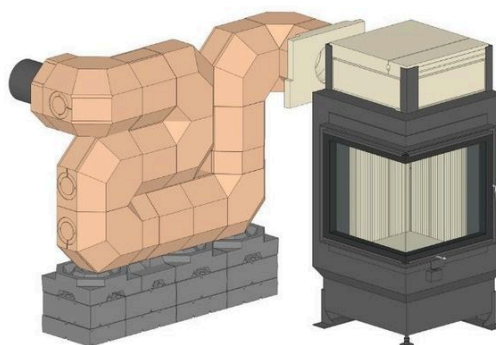

MSS heat storage set standing next in the corner right side 410 kg

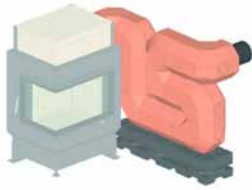

Set consists of:	Art. No.	No.	Price
Accumulation stone MSS connecting block / GOF side	G023205	1	
MSS elbow 90° with lining, double-layered	R013061	1	
MSS elbow 90° with cleanout top	R013019	3	
MSS outlet block ø 180 with sealing	R013067	1	
MSS heat storage module 10 cm	R013002	2	
MSS elbow 90°	R013005	2	
MSS steel tape ring, packaging steel tape 16 x 0,5	R013020	18	
MSS glue Thermofix 1000 1 kg	900133	2	
MSS heat storage module 20 cm	R013001	5	
MSSI insulating block 30x30 cm	R013108	3	
MSS elbow 90° with opening top	R013007	2	
MSS bypass 30 with sealings	R013073	1	
MSS base plate 100 30x30 cm	R013124	4	
MSSI insulating block 20x30 cm	R013107	1	
MSS heat storage module with lining 10 cm, double-layered	R013066	1	
MSS handle with rotating part	R013170	1	

Available variants:

MSS heat storage set standing next suitable for:		
GOF 50x35 + GOT 45/67/44-ZL lifting door/side opening door	SET211440	2370,50

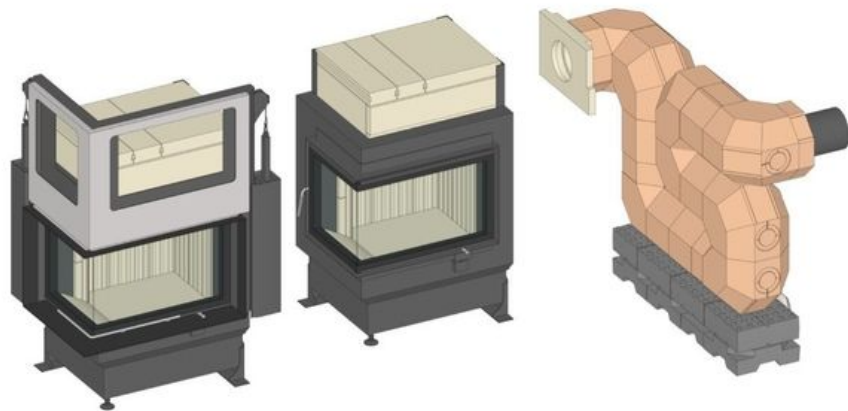

MSS heat storage set standing next in the corner left side 410 kg

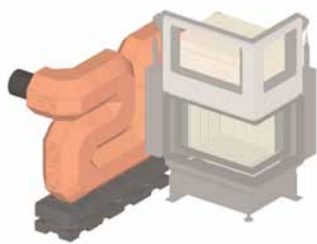

Set consists of:	Art. No.	No.	Price
Accumulation stone MSS connecting block / GOF side	G023204	1	
MSS elbow 90° with lining, double-layered	R013061	1	
MSS elbow 90° with cleanout top	R013019	3	
MSS outlet block ø 180 with sealing	R013067	1	
MSS heat storage module 10 cm	R013002	2	
MSS elbow 90°	R013005	2	
MSS steel tape ring, packaging steel tape 16 x 0,5	R013020	18	
MSS glue Thermofix 1000 1 kg	900133	2	
MSS heat storage module 20 cm	R013001	5	
MSSI insulating block 30x30 cm	R013108	3	
MSS elbow 90° with opening top	R013007	2	
MSS bypass 30 with sealings	R013073	1	
MSS base plate 100 30x30 cm	R013124	4	
MSSI insulating block 20x30 cm	R013107	1	
MSS heat storage module with lining 10 cm, double-layered	R013066	1	
MSS handle with rotating part	R013170	1	

Available variants:

MSS heat storage set standing next suitable for:			
GOF 50x35 + GOT 45/67/44-ZL lifting door/side opening door	SET211505		2370,50

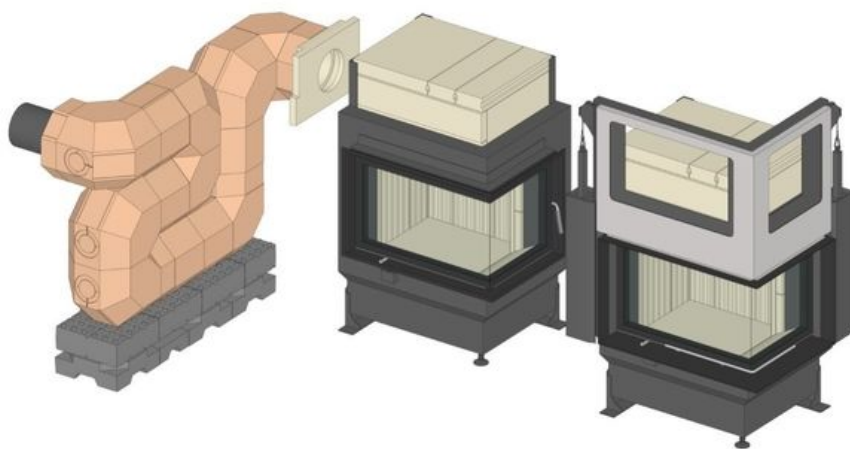

HKD

Flat

Eck

Tunnel

Tunnel

HKD

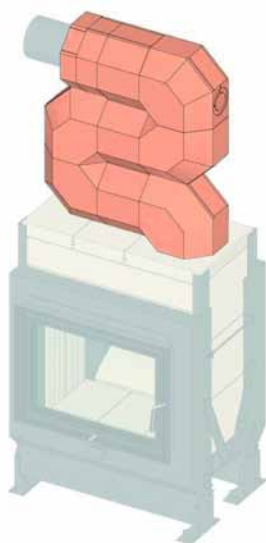

flat

MSS heat storage set standing on top 255 kg

Set consists of:	Art. No.	No.	Price
Accumulation stone MSS connecting block / GOF top cover	G017110	1	
MSS elbow 90° with lining, double-layered	R013061	1	
MSS elbow 90° with cleanout top	R013019	2	
MSS outlet block ø 180 with sealing	R013067	1	
MSS heat storage module 10 cm	R013002	1	
MSS elbow 90°	R013005	2	
MSS steel tape ring, packaging steel tape 16 x 0,5	R013020	10	
MSS glue Thermofix 1000 1 kg	900133	2	
MSS heat storage module 20 cm	R013001	3	
MSS handle with rotating part	R013170	1	

Available variants:

MSS heat storage set standing on top suitable for:			
GOF Tunnel 66x36 + GOT 51/67-ZL 2 side-opening doors	SET211414		1314,00

With the MSS set a flue outlet can be realized either to the left or right side.

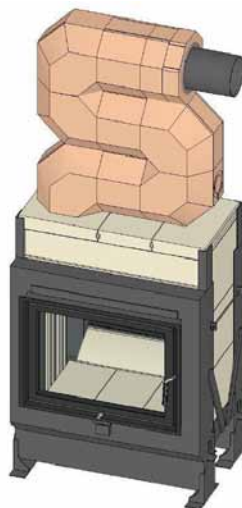

Eck

Tunnel

MSS heat storage set standing next 380 kg

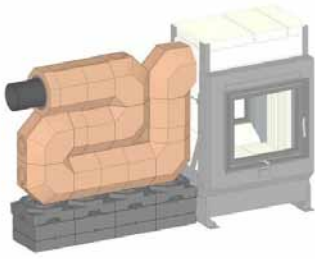

Set consists of:	Art. No.	No.	Price
Accumulation stone MSS connecting block / GOF side	G015108	1	
MSS elbow 90° with lining, double-layered	R013061	1	
MSS elbow 90° with cleanout top	R013019	3	
MSS outlet block ø 180 with sealing	R013067	1	
MSS heat storage module 10 cm	R013002	2	
MSS elbow 90°	R013005	1	
MSS steel tape ring, packaging steel tape 16 x 0,5	R013020	16	
MSS glue Thermofix 1000 1 kg	900133	2	
MSS heat storage module 20 cm	R013001	6	
MSSI insulating block 30x30 cm	R013108	4	
MSS elbow 90° with opening top	R013007	1	
MSS bypass 30 with sealings	R013073	1	
MSS base plate 75 30x30 cm	R013123	4	
MSS base plate 100 30x30 cm	R013124	4	
MSS heat storage module 20 cm with opening	R013003	1	
MSS handle with rotating part	R013170	1	

Available variants:

MSS heat storage set standing next suitable for:			
GOF Tunnel 66x36 + GOT 51/67-ZL 2 side-opening doors	SET211419		2333,50

The MSS accumulation block can be mounted either to the left or right side of the GOF

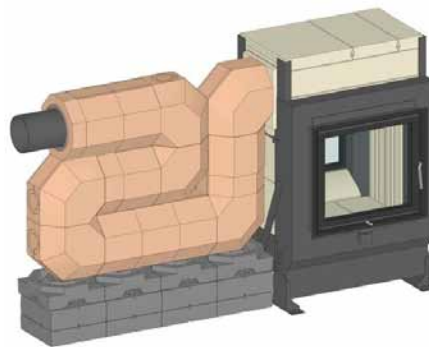

GNF Cast iron radiator

HKD



GNF 8

Set consists of:	Art. No.	No.	Price
GNF 8 without connecting pieces		1	
Connecting piece, inletø 180		1	
Connecting piece, outletø 160		1	

Additional options			
Connecting piece, inletø 200	07140		58,00
Connecting piece, inletø 160	07136		58,00
Connecting piece, outletø 180	07139		58,00
Connecting piece, inletø 145	R014017		58,00
Connecting piece, outletø 145	R014013		58,00
Support bearing GNF 8	N002099		159,50
Heat protective screen for GNF in connection with DF 33	R014032		154,00

Available variants:

GNF 8	SET212336		891,00
-------	-----------	--	---------------

flat

GNF 10



Set consists of:	Art. No.	No.	Price
GNF 10 without connecting pieces		1	
Connecting piece, inlet ø 180		1	
Connecting piece, outlet ø 160		1	

Additional options			
Connecting piece, inlet ø 200	07140		58,00
Connecting piece, inlet ø 160	07136		58,00
Connecting piece, outlet ø 180	07139		58,00
Connecting piece, outlet ø 145	R014013		58,00
Support bearing GNF 10	10828		174,00

Available variants:

GNF 10	SET211449		1237,00
--------	-----------	--	----------------

Eck

Tunnel

Fireplace construction plates and mortars



Fireplace construction plates (single)

	Art. No.	Price
Fireplace construction plate 250 x 1000 x 35	N007002	40,50
Fireplace construction plate 500 x 1000 x 35	N007003	80,50
Fireplace construction plate 500 x 750 x 35	N007004	60,50
Fireplace construction plate corner 250 x 250 x 125 x 35	N007005	39,00
Fireplace construction plate corner 500 x 250 x 125 x 35	N007006	64,50
Construction plate support profile 500 x 142 x 73 x 35	N007008	23,50

Fireplace construction plates (pallet)

	pallet/pcs.	Art. No.	Price
Fireplace construction plate 250 x 1000 x 35	34	N007002-P	1300,50
Fireplace construction plate 500 x 1000 x 35	17	N007003-P	1300,50
Fireplace construction plate 500 x 750 x 35	26	N007004-P	1514,50
Fireplace construction plate corner 250 x 250 x 125 x 35	42	N007005-P	1571,00
Fireplace construction plate corner 500 x 250 x 125 x 35	42	N007006-P	2564,50
Construction plate support profile 500 x 142 x 73 x 35	17	N007008-P	354,50



Thermal concrete plates

	Art. No.	Price
Thermal concrete plates 250 x 500 x 35	902336	32,00

Differences of colour due to manufacturing process are no reason for a claim.

Socle frame

	Art. No.	Price
Corner connector for socle frame	D028220	76,00
Socle frame length element L = 1200 mm	D028215	266,50
Socle frame length element L = 1795 mm	D028229	381,00

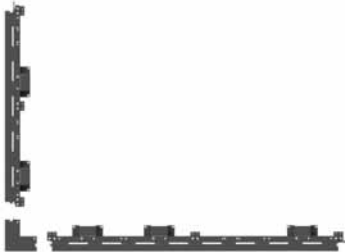



Adhesive and plastering mortars Spezial 1100

	Art. No.	Price
Adhesive and plastering mortars Spezial 1100 white 20 kg sack	900284	76,00
Adhesive and plastering mortars Spezial 1100 white 20 kg sack pallet = 48 sacks	900284P	3288,50
Glass fibre mesh (reinforcing mesh) 6x6	20079	164,50
Bucket with handle and lid for adhesive and plastering mortars Spezial 1100	900279	7,50



Adhesive and plastering mortars Universal 600

	Art. No.	Price
Adhesive and plastering mortars Universal 600 pure white 20 kg sack	900384	59,00
Adhesive and plastering mortars Universal 600 pure white 20 kg sack pallet = 48 sacks	900384P	2535,00
Glass fibre mesh (reinforcing mesh) 6x6	20079	164,50
Bucket with handle and lid for adhesive and plastering mortars Universal 600	900386	7,50





Plaster Coat

	Art. No.	Price
Plaster Coat 10 kg sack	902285	33,50
Plaster Coat 10 kg sack Pallet = 80 sacks	902285P	2538,00
Bucket with handle and lid for Plaster Coat	900387	7,50



Combustion chamber mortar

	Art. No.	Price
Combustion chamber mortar FM1300 beige 10 kg bucket	900129	41,50



Materials for surface refinement

	Art. No.	Price
Carnauba wax emulsion concentrate 0,5 l bottle	900285	27,00
Revisional materials BSK/BSO/KSO consisting of: japanese putty, sandpaper, 400 g filler, 250 g top coat	900300	21,50



Accessories construction material



	Art. No.	Price
Special masking tape 50 m	02576	9,50

HKD

Flat

Eck

Tunnel

USA, EOS, EAS



USA 3

Article description	Art. No.	Price
USA negative pressure safety device "USA-3"	E007068	816,50
Accessories USA		
Smoke sensor connection for "USA"	E007063	197,00
Smoke sensor connection for "USA-2" in combination with MSS	E007058	60,50
Exhaust gas connection for "USA" in combination with ceramic storage	E007055-03	115,00
Mounting box	900001	13,00
Mounting box for dry wall installation	E004007-01	83,50
Negative pressure hose (by metre)	11602	11,00
Sensor wiring 2 lm	12120	26,00
Sensor wiring 3 lm	12121	35,00
Sensor wiring 4 lm	12122	41,50
Sensor wiring 5 lm	12123	47,50
Sensor wiring 7 lm	12125	62,50
Sensor wiring 10 lm	12124	87,50
Handmonitor for USA	900201	181,50

Article description	Art. No.	Price
Collars for smoke pipes		
Concentric collar ø 150 mm	E007043-1	137,50
Concentric collar ø 130 mm	E007045-1	137,50
Concentric collar ø 180 mm	E007092-01	149,50



USA 4

Article description	Art. No.	Price
USA negative pressure safety device "USA-4"	E007125	776,00
Accessories USA		
Smoke sensor connection for "USA"	E007063	197,00
Smoke sensor connection for "USA-2" in combination with MSS	E007058	60,50
Exhaust gas connection for "USA" in combination with ceramic storage	E007055-03	115,00
Mounting box	901101	9,50
Mounting box for dry wall installation	901104	36,50
Negative pressure hose (by metre)	11602	11,00
Sensor wiring 2 lm	12120	26,00
Sensor wiring 3 lm	12121	35,00
Sensor wiring 4 lm	12122	41,50
Sensor wiring 5 lm	12123	47,50
Sensor wiring 7 lm	12125	62,50
Sensor wiring 10 lm	12124	87,50

Article description	Art. No.	Price
Collars for smoke pipes		
Concentric collar ø 150 mm	E007043-1	137,50
Concentric collar ø 130 mm	E007045-1	137,50
Concentric collar ø 180 mm	E007092-01	149,50

USA, EOS, EAS



USA 4 Funk

Article description	Art. No.	Price
USA negative pressure safety device USA-4 Funk	E007109	1191,00
with 1 x radio receiver		
Accessories USA 4 Funk		
Smoke sensor connection for "USA"	E007063	197,00
Smoke sensor connection for "USA-2" in combination with MSS	E007058	60,50
Exhaust gas connection for "USA" in combination with ceramic storage	E007055-03	115,00
Mounting box	901101	9,50
Mounting box for dry wall installation	901104	36,50
Negative pressure hose (by metre)	11602	11,00
Sensor wiring 2 lm	12120	26,00
Sensor wiring 3 lm	12121	35,00
Sensor wiring 4 lm	12122	41,50
Sensor wiring 5 lm	12123	47,50
Sensor wiring 7 lm	12125	62,50
Sensor wiring 10 lm	12124	87,50

Article description	Art. No.	Price
Special accessory		
radio receiver, max. amount/USA: 3 radio receiver	E007065	320,50
Radio Repeater for USA 4 , signal amplifier	E007096	511,50

Article description	Art. No.	Price
Collars for smoke pipes		
Concentric collar ø 150 mm	E007043-1	137,50
Concentric collar ø 130 mm	E007045-1	137,50
Concentric collar ø 180 mm	E007092-01	149,50



EOS 8

Article description		Art. No.	Price
EOS 8 display-and control unit white Not available at the time	■	E004071	1615,00
EOS 8 display-and control unit black Not available at the time		E004073	1615,00
EOS 8 display-and control unit white without WiFi-Chip		E004084	1587,00
EOS 8 display-and control unit black without WiFi-Chip		E004086	1587,00
Mounting box			
Mounting box EOS/EAS/USA	■	900001	13,00
Mounting box for dry wall installation EOS/EAS/USA		E004007-01	83,50
Wall- mount box controll unit	■	902261	36,50
Connection door switch wiring EOS			
Door switch wiring EAS/EOS sensor wiring USA - 2 lm	■	12120	26,00
Door switch wiring EAS/EOS Fühlerleitung USA - 3 lm		12121	35,00
Door switch wiring EAS/EOS sensor wiring USA - 4 lm		12122	41,50
Door switch wiring EAS/EOS sensor wiring USA - 5 lm		12123	47,50
Door switch wiring EAS/EOS sensor wiring USA - 7 lm		12125	62,50
Door switch wiring EAS/EOS sensor wiring USA - 10 lm		12124	87,50
Connection thermocouple EOS			
Thermocouple wiring-T1/T3 2 lm	■	10958	28,50
Thermocouple wiring-T1/T3 3 lm		10959	37,50
Thermocouple wiring-T1/T3 4 lm		10960	45,50
Thermocouple wiring-T1/T3 5 lm		10961	56,00
Thermocouple wiring-T1/T3 7 lm		10963	71,00
Thermocouple wiring-T1/T3 10 lm		10962	99,00
Connection K1 to EOS			
Bus wiring-K1 2 lm	■	12150	40,00
Bus wiring-K1 3 lm		12151	47,50
Bus wiring-K1 4 lm		12152	54,50
Bus wiring-K1 5 lm		12153	62,00
Bus wiring-K1 7 lm		12154	72,00
Bus wiring-K1 10 lm		12155	93,00
motorized damper flap			
motorized damper flap D=180 mm	■	SET210596	690,50
motorized damper flap D=200 mm		SET210597	702,50
motorized damper flap D=250 mm		SET210598	713,00
Connection wiring K1-K2			
Connection wiring K1-K2 2 lm	■	E013009-2	36,00
Connection wiring K1-K2 3 lm		E013009-3	41,00
Connection wiring K1-K2 4 lm		E013009-4	46,00
Connection wiring K1-K2 5 lm		E013009-5	52,00
Connection wiring K1-K2 7 lm		E013009-7	63,00
Connection wiring K1-K2 10 lm		E013009-10	76,50

USA, EOS, EAS

Article description		Art. No.	Price
Extended functionality sensors			
Thermocouple long with ceramic sleeve M12 and complete screw fitting (T1 and T3)	<input type="checkbox"/>	10994.1	154,00
Temperature sensor with immersion sleeve for water to smoke valve actuator (T2,T4,T6,T7)		10339	37,50
Connection display to control unit EOS			
Connection wiring EOS display-control unit - 2 lm	<input type="checkbox"/>	E013001-2	23,50
Connection wiring EOS display-control unit - 3 lm		E013001-3	25,50
Connection wiring EOS display-control unit - 4 lm		E013001-4	28,50
Connection wiring EOS display-control unit - 5 lm		E013001-5	31,00
Connection wiring EOS display-control unit - 7 lm		E013001-7	37,50
Connection wiring EOS display-control unit - 10 lm		E013001-10	45,00
Connection control unit to T2/T4 (screened cable)			
Extension wiring EWM/T2,T4,T6,T7 - 3 lm	<input type="checkbox"/>	E013013-01	35,00
Extension wiring EWM/T2,T4,T6,T7 - 5 lm		E013013-02	40,00
Extension wiring EWM/T2,T4,T6,T7 - 10 lm		E013013-03	58,00
Extension wiring EWM/T2,T4,T6,T7 - 15 lm		E013013-04	72,00
Connection EOS with BHZ			
Connection wiring EOS control unit BHZ and EWP - 0,7 lm	<input type="checkbox"/>	E013005-1	18,00
Connection wiring EOS control unit BHZ and EWP - 2 lm		E013005-2	21,00
Connection wiring EOS control unit BHZ and EWP - 3 lm		E013005-3	23,50
Connection wiring EOS control unit BHZ and EWP - 4 lm		E013005-4	25,50
Connection wiring EOS control unit BHZ and EWP - 5 lm		E013005-5	29,00
Connection wiring EOS control unit BHZ and EWP - 7 lm		E013005-7	33,50
Connection wiring EOS control unit BHZ and EWP - 10 lm		E013005-10	43,00
Flap actuator			
smoke valve actuator L/R - rotating with drive box	<input type="checkbox"/>	10338	632,00
Accessories flap actuator			
flexible Shaft 490 mm	<input type="checkbox"/>	10340	79,00
flexible Shaft 1200 mm		S004029	228,00
Control shaft d=8mm, length 360 mm for flue gas T-pipe		00669	68,50
Coupling 12/12 for elongation piece for square bar with flexible shaft		10273	12,50
Insulation for drive box / flap actuator "M2"		10329	85,50
Article description			
Brunner Smart Home			
BSH Module Precondition: EOS 8		E004076	481,00

Extension board zur EOS



EAS

Article description		Art. No.	Price
EAS 3 control unit with display	■	E005017	604,00
EAS 3 control unit without Display		E005018	456,00
Mounting box			
Mounting box EOS/EAS/USA	■	900001	13,00
Mounting box for dry wall installation EOS/EAS/USA		E004007-01	83,50
Connection door switch wiring EAS			
Door switch wiring EAS/EOS sensor wiring USA - 2 lm	■	12120	26,00
Door switch wiring EAS/EOS sensor wiring USA - 3 lm		12121	35,00
Door switch wiring EAS/EOS sensor wiring USA - 4 lm		12122	41,50
Door switch wiring EAS/EOS sensor wiring USA - 5 lm		12123	47,50
Door switch wiring EAS/EOS sensor wiring USA - 7 lm		12125	62,50
Door switch wiring EAS/EOS sensor wiring USA - 10 lm		12124	87,50
Connection thermocouple EAS			
Thermocouple wiring-T1/T3 2 lm	■	10958	28,50
Thermocouple wiring-T1/T3 3 lm		10959	37,50
Thermocouple wiring-T1/T3 4 lm		10960	45,50
Thermocouple wiring-T1/T3 5 lm		10961	56,00
Thermocouple wiring-T1/T3 7 lm		10963	71,00
Thermocouple wiring-T1/T3 10 lm		10962	99,00
Connection K1 to EAS			
Bus wiring-K1 2 lm	■	12150	40,00
Bus wiring-K1 3 lm		12151	47,50
Bus wiring-K1 4 lm		12152	54,50
Bus wiring-K1 5 lm		12153	62,00
Bus wiring-K1 7 lm		12154	72,00
Bus wiring-K1 10 lm		12155	93,00
motorized damper flap			
motorized damper flap D=180 mm	■	SET210596	690,50
motorized damper flap D=200 mm		SET210597	702,50
motorized damper flap D=250 mm		SET210598	713,00
Connection wiring K1-K2			
Connection wiring K1-K2 2 lm	■	E013009-2	36,00
Connection wiring K1-K2 3 lm		E013009-3	41,00
Connection wiring K1-K2 4 lm		E013009-4	46,00
Connection wiring K1-K2 5 lm		E013009-5	52,00
Connection wiring K1-K2 7 lm		E013009-7	63,00
Connection wiring K1-K2 10 lm		E013009-10	76,50

Contact.

Phone +49 8721 771-0

Export Sales + 49 8721 771- 250

export@brunner.de

Katharina Punzmann
Order processing - export

punzmann@brunner.de
Direct dialing ...-241

Ilona Witte
Order processing - export

ilona.witte@brunner.eu
Direct dialing ...-128

Service support + 49 8721 771-638

Markus Soutschek

soutschek@brunner.de

Ulrich Brunner GmbH
Zellhuber Ring 17 - 18
D-84307 Eggenfelden
www.brunner.de

BRUNNER products are offered and sold only by qualified dealers and service centres.

Stand 04/2023 Subject to technical and assortment changes. Errors excepted.

Subject to our "General terms and conditions of business". www.brunner.de/AGB

BRUNNER®